

Compact Inverter

FRENIC-Mini

CAUTION

Thank you for purchasing our FRENIC-Mini series of inverters.

- This product is designed to drive a three-phase induction motor. Read through this instruction manual and be familiar with the handling procedure for correct use.
- Improper handling might result in incorrect operation, a short life, or even a failure of this product as well as the motor.
- Deliver this manual to the end user of this product. Keep this manual in a safe place until this product is discarded.
- For how to use an optional device, refer to the instruction and installation manuals for that optional device.

Copyright © 2002-2007 Fuji Electric FA Components & Systems Co., Ltd.

All rights reserved.

No part of this publication may be reproduced or copied without prior written permission from Fuji Electric FA Components & Systems Co., Ltd.

All products and company names mentioned in this manual are trademarks or registered trademarks of their respective holders.

The information contained herein is subject to change without prior notice for improvement.

Preface

Thank you for purchasing our FRENIC-Mini series of inverters.

This product is designed to drive a three-phase induction motor. Read through this instruction manual and be familiar with proper handling and operation of this product.

Improper handling might result in incorrect operation, a short life, or even a failure of this product as well as the motor.

Have this manual delivered to the end user of this product. Keep this manual in a safe place until this product is discarded.

Listed below are the other materials related to the use of the FRENIC-Mini. Read them in conjunction with this manual as necessary.

- FRENIC-Mini User's Manual (MEH446)
- RS-485 Communication User's Manual (MEH448)
- Catalog (MEH441/MEH451)
- Application Guide (MEH449)
- RS-485 Communications Card Installation Manual (INR-SI47-0773)
- Rail Mounting Base Installation Manual (INR-SI47-0774)
- Mounting Adapter Installation Manual (INR-SI47-0775)
- FRENIC Loader Instruction Manual (INR-SI47-0903-E)
- Remote Keypad Instruction Manual (INR-SI47-0843-E)
- Built-in Braking Resistor Installation Manual (INR-SI47-0838)

The materials are subject to change without notice. Be sure to obtain the latest editions for use.

Japanese Guideline for Suppressing Harmonics in Home Electric and General-purpose Appliances

Fuji three-phase 200 V class series of inverters with a capacity of 3.7 (4.0) kW or less, single-phase 200 V class series with 2.2 kW or less, and single-phase 100 V class series with 0.75 kW or less were once subject to the "Japanese Guideline for Suppressing Harmonics in Home Electric and General-purpose Appliances" (established in September 1994 and revised in October 1999), published by the Ministry of International Trade and Industry (currently the Ministry of Economy, Trade and Industry (METI)).

Since the revision of the guideline in January 2004, however, these inverters have no longer been subject to the guideline. The individual inverter manufacturers have voluntarily employed harmonics suppression measures.

As our measure, it is recommended that DC reactors (DCRs) authorized in this manual be connected to the FRENIC-Mini series of inverters.

When using DCRs not authorized in this manual, however, consult your Fuji Electric representative for the detailed specifications.



Japanese Guideline for Suppressing Harmonics by Customers Receiving High Voltage or Special High Voltage

Refer to the FRENIC-Mini User's Manual (MEH446), Appendix C for details on this guideline.

■ Safety precautions

Read this manual thoroughly before proceeding with installation, connections (wiring), operation, or maintenance and inspection. Ensure you have sound knowledge of the device and familiarize yourself with all safety information and precautions before proceeding to operate the inverter.

Safety precautions are classified into the following two categories in this manual.

 WARNING	Failure to heed the information indicated by this symbol may lead to dangerous conditions, possibly resulting in death or serious bodily injuries.
 CAUTION	Failure to heed the information indicated by this symbol may lead to dangerous conditions, possibly resulting in minor or light bodily injuries and/or substantial property damage.

Failure to heed the information contained under the CAUTION title can also result in serious consequences. These safety precautions are of utmost importance and must be observed at all times.

Application

 WARNING
<ul style="list-style-type: none">• FRENIC-Mini is designed to drive a three-phase induction motor. Do not use it for single-phase motors or for other purposes. Fire or an accident could occur.• FRENIC-Mini may not be used for a life-support system or other purposes directly related to the human safety.• Though FRENIC-Mini is manufactured under strict quality control, install safety devices for applications where serious accidents or material losses are foreseen in relation to the failure of it. An accident could occur.

Installation

 WARNING
<ul style="list-style-type: none">• Install the inverter on a nonflammable material such as metal. Otherwise fire could occur.• Do not place flammable matter nearby. Doing so could cause fire.

CAUTION

- Do not support the inverter by its terminal block cover during transportation.
Doing so could cause a drop of the inverter and injuries.
- Prevent lint, paper fibers, sawdust, dust, metallic chips, or other foreign materials from getting into the inverter or from accumulating on the heat sink.
Otherwise, a fire or an accident might result.
- Do not install or operate an inverter that is damaged or lacking parts.
Doing so could cause fire, an accident or injuries.
- Do not get on a shipping box.
- Do not stack shipping boxes higher than the indicated information printed on those boxes.
Doing so could cause injuries.

Wiring

WARNING

- When wiring the inverter to the power source, insert a recommended molded case circuit breaker (MCCB) or residual-current-operated protective device (RCD)/earth leakage circuit breaker (ELCB) (with overcurrent protection) in the path of power lines. Use the devices within the recommended current range.
- Use wires in the specified size.
- When wiring the inverter to the power supply of 500 kVA or more (50 kVA or more for the single-phase 100 V class series of inverters), be sure to connect an optional DC reactor (DCR).
Otherwise, fire could occur.
- Do not use one multicore cable in order to connect several inverters with motors.
- Do not connect a surge killer to the inverter's output (secondary) circuit.
Doing so could cause fire.
- Be sure to connect the grounding wires without fail.
Otherwise, electric shock or fire could occur.
- Qualified electricians should carry out wiring.
- Be sure to perform wiring after turning the power off.
- Ground the inverter following Class C or Class D specifications or national/local electric code, depending on the input voltage of the inverter.
Otherwise, electric shock could occur.
- Be sure to perform wiring after installing the inverter body.
Otherwise, electric shock or injuries could occur.
- Ensure that the number of input phases and the rated voltage of the product match the number of phases and the voltage of the AC power supply to which the product is to be connected.
Otherwise fire or an accident could occur.
- Do not connect the power source wires to output terminals (U, V, and W).
- Do not insert a braking resistor between terminals P (+) and N (-), P1 and N (-), P (+) and P1, DB and N (-), or P1 and DB.
Doing so could cause fire or an accident.

WARNING

- Generally, control signal wires are not reinforced insulation. If they accidentally touch any of live parts in the main circuit, their insulation coat may break for any reasons. In such a case, an extremely high voltage may be applied to the signal lines. Make a complete remedy to protect the signal line from contacting any hot high voltage lines.

Doing so could cause an accident or electric shock.

CAUTION

- Wire the three-phase motor to terminals U, V, and W of the inverter, aligning phases each other.
Otherwise injuries could occur.
- The inverter, motor and wiring generate electric noise. Take care of malfunction of the nearby sensors and devices. To prevent the motor from malfunctioning, implement noise control measures.

Otherwise an accident could occur.

Operation

WARNING

- Be sure to install the terminal block cover before turning the power on. Do not remove the cover while power is applied.
Otherwise electric shock could occur.
- Do not operate switches with wet hands.
Doing so could cause electric shock.
- If the retry function has been selected, the inverter may automatically restart and drive the motor depending on the cause of tripping.
(Design the machinery or equipment so that human safety is ensured after restarting.)
- If the stall prevention function (current limiter), automatic deceleration, and overload prevention control have been selected, the inverter may operate at an acceleration/deceleration time or frequency different from the set ones. Design the machine so that safety is ensured even in such cases.
Otherwise an accident could occur.
- The STOP key is only effective when function setting (Function code F02) has been established to enable the STOP key. Prepare an emergency stop switch separately. If you disable the STOP key priority function and enable operation by external commands, you cannot emergency-stop the inverter using the STOP key on the built-in keypad.
- If an alarm reset is made with the operation signal turned on, a sudden start will occur. Ensure that the operation signal is turned off in advance.
Otherwise an accident could occur.

WARNING

- If you enable the "restart mode after momentary power failure" (Function code F14 = 4 or 5), then the inverter automatically restarts running the motor when the power is recovered. (Design the machinery or equipment so that human safety is ensured after restarting.)
- If you set the function codes wrongly or without completely understanding this instruction manual and the FRENIC-Mini User's Manual, the motor may rotate with a torque or at a speed not permitted for the machine.

An accident or injuries could occur.

- Do not touch the inverter terminals while the power is applied to the inverter even if the inverter stops.

Doing so could cause electric shock.

CAUTION

- Do not turn the main circuit power on or off in order to start or stop inverter operation.
Doing so could cause failure.
- Do not touch the heat sink or braking resistor because they become very hot.
Doing so could cause burns.
- Setting the inverter to high speeds is easy. Before changing the frequency (speed) setting, check the specifications of the motor and machinery.
- The brake function of the inverter does not provide mechanical holding means.
Injuries could occur.

Wiring length for EMC filter built-in type

CAUTION

- When the wiring length between the inverter and motor exceeds 10 m, the filter circuit may be overheated and damaged due to increase of leakage current. To reduce the leakage current, set the motor sound (carrier frequency) to 2 kHz or below with function code F26.
Otherwise a failure could occur.

Installation and wiring of an option card

WARNING

- Before installing an RS-485 Communications Card, turn off the power, wait more than five minutes, and make sure, using a circuit tester or a similar instrument, that the DC link bus voltage between the terminals P (+) and N (-) has dropped below a safe voltage (+25 VDC).
- Do not remove the terminal cover for the control circuits while power is applied, because high voltage lines exist on the RS-485 Communications Card.

Failure to observe these precautions could cause electric shock.

WARNING

- In general, sheaths and covers of the control signal cables and wires are not specifically designed to withstand a high electric field (i.e., reinforced insulation is not applied). Therefore, if a control signal cable or wire comes into direct contact with a live conductor of the main circuit, the insulation of the sheath or the cover might break down, which would expose the signal wire to a high voltage of the main circuit. Make sure that the control signal cables and wires will not come into contact with live conductors of the main circuits.
Failure to observe these precautions could cause electric shock and/or an accident.

Maintenance and inspection, and parts replacement

WARNING

- Turn the power off and wait for at least five minutes before starting inspection. Further, check that the LED monitor is unlit, and check the DC link bus voltage between the P (+) and N (-) terminals to be lower than 25 VDC.
Otherwise, electric shock could occur.
- Maintenance, inspection, and parts replacement should be made only by qualified persons.
- Take off the watch, rings and other metallic matter before starting work.
- Use insulated tools.
Otherwise, electric shock or injuries could occur.

Disposal

CAUTION

- Handle the inverter as an industrial waste when disposing of it.
Otherwise injuries could occur.

Others

WARNING

- Never attempt to modify the inverter.
Doing so could cause electric shock or injuries.

GENERAL PRECAUTIONS

Drawings in this manual may be illustrated without covers or safety shields for explanation of detail parts. Restore the covers and shields in the original state and observe the description in the manual before starting operation.

Conformity to the Low Voltage Directive in the EU

If installed according to the guidelines given below, inverters marked with CE or TÜV are considered as compliant with the Low Voltage Directive 73/23/EEC.

CAUTION

1. The ground terminal  G should always be connected to the ground. Do not use only a residual-current-operated protective device (RCD)/earth leakage circuit breaker (ELCB)* as the sole method of electric shock protection. Be sure to use ground wires whose size is greater than power supply lines.

* With overcurrent protection.

2. When used with the inverter, a molded case circuit breaker (MCCB), residual-current-operated protective device (RCD)/earth leakage circuit breaker (ELCB) or magnetic contactor (MC) should conform to the EN or IEC standards.
3. When you use a residual-current-operated protective device (RCD)/earth leakage circuit breaker (ELCB) for protection from electric shock in direct or indirect contact power lines or nodes, be sure to install **type B of RCD/ELCB** on the input (primary) of the inverter if the power source is three-phase 200/400 V. For single-phase 200 V power supplies, use **type A**.

When you use no RCD/ELCB, take any other protective measure that isolates the electric equipment from other equipment on the same power supply line using double or reinforced insulation or that isolates the power supply lines connected to the electric equipment using an isolation transformer.

4. The inverter should be used in an environment that does not exceed Pollution Degree 2 requirements. If the environment conforms to Pollution Degree 3 or 4, install the inverter in an enclosure of IP54 or higher.
5. Install the inverter, AC or DC reactor, input or output filter in an enclosure with minimum degree of protection of IP2X (Top surface of enclosure shall be minimum IP4X when it can be easily accessed), to prevent human body from touching directly to live parts of these equipment.
6. To make an inverter with no integrated EMC filter conform to the EMC directive, it is necessary to connect an external EMC filter to the inverter and install them properly so that the entire equipment including the inverter conforms to the EMC directive.
7. Do not connect any copper wire directly to grounding terminals. Use crimp terminals with tin or equivalent plating to connect them.
8. To connect the three-phase or single-phase 200 V class series of inverters to the power supply in Overvoltage Category III or to connect the three-phase 400 V class series of inverters to the power supply in Overvoltage Category II or III, a supplementary insulation is required for the control circuitry.
9. When using inverters at an altitude of more than 2000 m, note that the basic insulation applies to the insulation degree of the control circuitry. At an altitude of more than 3000 m, inverters cannot be used.
10. The power supply mains neutral has to be earthed for the three-phase 400 V class inverter.

Conformity to the Low Voltage Directive in the EU (Continued)

⚠ CAUTION

11. Use wires listed in EN60204 Appendix C.

Power supply voltage	Applicable motor rating (kW)	Inverter type	Rated current (A) ^{*1} of MCCB or RCD/ELCB		Recommended wire size (mm ²) ^{*2}				Control circuit (30A, 30B, 30C)			
					Main circuit power input [L1/R, L2/S, L3/T] [L1/L, L2/N] Grounding [⊕G]	Inverter output [U, V, W]	DCR [P1, P (+)] Braking resistor [P (+), DB]					
			w/ DCR	w/o DCR ^{*3}						w/ DCR	w/o DCR ^{*3}	
Three-phase 200 V	0.1	FRN0.1C1■-2□	6	6	2.5	2.5	2.5	2.5	0.5			
	0.2	FRN0.2C1■-2□										
	0.4	FRN0.4C1■-2□										
	0.75	FRN0.75C1■-2□	10	10								
	1.5	FRN1.5C1■-2□**		16								
	2.2	FRN2.2C1■-2□**	20									
	3.7	FRN3.7C1■-2□**	20	35						4	4	
Three-phase 400 V	0.4	FRN0.4C1■-4□	6	6	2.5	2.5	2.5	2.5	0.5			
	0.75	FRN0.75C1■-4□										
	1.5	FRN1.5C1■-4□**								10		
	2.2	FRN2.2C1■-4□**	10	16								
	3.7	FRN3.7C1■-4□**		20								
	4.0	FRN4.0C1■-4□**										
Single-phase 200 V	0.1	FRN0.1C1■-7□	6	6	2.5	2.5	2.5	2.5	0.5			
	0.2	FRN0.2C1■-7□										
	0.4	FRN0.4C1■-7□								10		
	0.75	FRN0.75C1■-7□	10	16								
	1.5	FRN1.5C1■-7□	16	20						4		
	2.2	FRN2.2C1■-7□	20	35						4	6	4

MCCB: Molded case circuit breaker
RCD: Residual-current-operated protective device
ELCB: Earth leakage circuit breaker

- Notes 1) A box (■) in the above table replaces S or E depending on the enclosure.
2) A box (□) in the above table replaces A, C, E, or J depending on the shipping destination.
3) Asterisks (**) in the above table denote the following:
21: Braking resistor built-in type; None: Standard

*1 The frame size and model of the MCCB or RCD/ELCB (with overcurrent protection) will vary, depending on the power transformer capacity. Refer to the related technical documentation for details.

*2 The recommended wire size for main circuits is for the 70°C 600V PVC wires used at an ambient temperature of 40°C.

*3 In the case of no DC reactor, the wire sizes are determined on the basis of the effective input current calculated under the condition that the power supply capacity and impedance are 500 kVA and 5%, respectively.

Conformity to UL standards and Canadian standards (cUL certification)

If installed according to the guidelines given below, inverters marked with UL/cUL are considered as compliant with the UL and CSA (cUL certified) standards.

CAUTION

1. Solid state motor overload protection (motor protection by electronic thermal overload relay) is provided in each model.
Use function codes F10 to F12 to set the protection level.
2. Connect the power supply satisfying the characteristics shown in the table below as an input power supply of the inverter.(Short circuit rating)
3. Use 75°C Cu wire only.
4. Use Class 1 wire only for control circuits.
5. Field wiring connections must be made by a UL Listed and CSA Certified closed-loop terminal connector sized for the wire gauge involved. Connector must be fixed using the crimp tool specified by the connector manufacturer.

Short circuit rating

Suitable for use on a circuit capable of delivering not more than B rms symmetrical amperes, A volts maximum.

Power supply voltage	Inverter type	Power supply max. voltage A	Power supply current B
Three-phase 200V	FRN0.1C1■-2□	240 VAC	100,000 A or less
	FRN0.2C1■-2□		
	FRN0.4C1■-2□		
	FRN0.75C1■-2□		
	FRN1.5C1■-2□**		
	FRN2.2C1■-2□**		
Three-phase 400V	FRN3.7C1■-2□**		
	FRN0.4C1■-4□	480 VAC	100,000 A or less
	FRN0.75C1■-4□		
	FRN1.5C1■-4□**		
	FRN2.2C1■-4□**		
	FRN3.7C1■-4□**		
FRN4.0C1■-4□**			
Single-phase 200V	FRN0.1C1■-7□	240 VAC	100,000 A or less
	FRN0.2C1■-7□		
	FRN0.4C1■-7□		
	FRN0.75C1■-7□		
	FRN1.5C1■-7□		
	FRN2.2C1■-7□		
Single-phase 100V	FRN0.1C1■-6□	120 VAC	65,000 A or less
	FRN0.2C1■-6□		
	FRN0.4C1■-6□		
	FRN0.75C1■-6□		

- Notes
- 1) A box (■) in the above table replaces S or E depending on the enclosure.
 - 2) A box (□) in the above table replaces A, C, E, or J depending on the shipping destination.
 - 3) Asterisks (**) in the above table denote the following:
21: Braking resistor built-in type; None: Standard

Conformity to UL standards and Canadian standards (cUL certification) (Continued)

⚠ CAUTION

6. Install UL certified fuses between the power supply and the inverter, referring to the table below.

Power supply voltage	Inverter type	Required torque lb-in (N·m)			Wire size AWG or kcmil (mm ²)			Class J fuse current (A)
		Main terminal	Control circuit		Main terminal	Control circuit		
			*1 TERM1	*2 TERM2-1 TERM2-2		*1 TERM1	*2 TERM2-1 TERM2-2	
Three-phase 200V	FRN0.1C1■-2□	10.6 (1.2)	3.5 (0.4)	1.8 (0.2)	14	20 (0.5)	3	
	FRN0.2C1■-2□						6	
	FRN0.4C1■-2□						10	
	FRN0.75C1■-2□						15	
	FRN1.5C1■-2□**	15.9 (1.8)	10	20				
	FRN2.2C1■-2□**			30				
	FRN3.7C1■-2□**			40				
Three-phase 400V	FRN0.4C1■-4□	15.9 (1.8)	3.5 (0.4)	1.8 (0.2)	14	20 (0.5)	3	
	FRN0.75C1■-4□						6	
	FRN1.5C1■-4□**						10	
	FRN2.2C1■-4□**						15	
	FRN3.7C1■-4□**						20	
	FRN4.0C1■-4□**							
Single-phase 200V	FRN0.1C1■-7□	10.6 (1.2)	3.5 (0.4)	1.8 (0.2)	14	20 (0.5)	6	
	FRN0.2C1■-7□						6	
	FRN0.4C1■-7□						10	
	FRN0.75C1■-7□						15	
	FRN1.5C1■-7□	15.9 (1.8)	10	30				
	FRN2.2C1■-7□			40				
Single-phase 100V	FRN0.1C1■-6□	10.6 (1.2)	3.5 (0.4)	1.8 (0.2)	14	20 (0.5)	6	
	FRN0.2C1■-6□						10	
	FRN0.4C1■-6□						15	
	FRN0.75C1■-6□						30	

Notes 1) A box (■) in the above table replaces S or E depending on the enclosure.

2) A box (□) in the above table replaces A, C, E, or J depending on the shipping destination.

3) Asterisks (**) in the above table denote the following:



21: Braking resistor built-in type; None: Standard

*1 Denotes the relay contact terminals for [30A], [30B] and [30C].

*2 Denotes control terminals except for [30A], [30B] and [30C].

■ Precautions for use

In running general-purpose motors	Driving a 400 V general-purpose motor	When driving a 400 V general-purpose motor with an inverter using extremely long wires, damage to the insulation of the motor may occur. Use an output circuit filter (OFL) if necessary after checking with the motor manufacturer. Fuji motors do not require the use of output circuit filters because of their good insulation.
	Torque characteristics and temperature rise	When the inverter is used to run a general-purpose motor, the temperature of the motor becomes higher than when it is operated using a commercial power supply. In the low-speed range, the cooling effect will be weakened, so decrease the output torque of the motor. If constant torque is required in the low-speed range, use a Fuji inverter motor or a motor equipped with an externally powered ventilating fan.
	Vibration	When an inverter-driven motor is mounted to a machine, resonance may be caused by the natural frequencies of the machine system. Note that operation of a 2-pole motor at 60 Hz or higher may cause abnormal vibration. * The use of a rubber coupling or vibration dampening rubber is recommended. * Use the inverter's jump frequency control feature to skip the resonance frequency zone(s).
	Noise	When an inverter is used with a general-purpose motor, the motor noise level is higher than that with a commercial power supply. To reduce noise, raise carrier frequency of the inverter. Operation at 60 Hz or higher can also result in higher noise level.
In running special motors	High-speed motors	If the reference frequency is set to 120 Hz or more to drive a high-speed motor, test-run the combination of the inverter and motor beforehand to check for safe operation.
	Explosion-proof motors	When driving an explosion-proof motor with an inverter, use a combination of a motor and an inverter that has been approved in advance.
	Submersible motors and pumps	These motors have a larger rated current than general-purpose motors. Select an inverter whose rated output current is greater than that of the motor. These motors differ from general-purpose motors in thermal characteristics. Set a low value in the thermal time constant of the motor when setting the electronic thermal function.
	Brake motors	For motors equipped with parallel-connected brakes, their braking power must be supplied from the input (primary) circuit. If the brake power is connected to the inverter's output (secondary) circuit by mistake, the brake will not work. Do not use inverters for driving motors equipped with series-connected brakes.

In running special motors	Geared motors	If the power transmission mechanism uses an oil-lubricated gearbox or speed changer/reducer, then continuous motor operation at low speed may cause poor lubrication. Avoid such operation.
	Synchronous motors	It is necessary to take special measures suitable for this motor type. Contact your Fuji Electric representative for details.
	Single-phase motors	Single-phase motors are not suitable for inverter-driven variable speed operation. Use three-phase motors. * Even if a single-phase power supply is available, use a three-phase motor as the inverter provides three-phase output.
Environmental conditions	Installation location	Use the inverter within the ambient temperature range from -10 to +50°C. The heat sink and braking resistor of the inverter may become hot under certain operating conditions, so install the inverter on nonflammable material such as metal. Ensure that the installation location meets the environmental conditions specified in Chapter 2, Section 2.1 "Operating Environment."
Combination with peripheral devices	Installing an MCCB or RCD/ELCB	Install a recommended molded case circuit breaker (MCCB) or residual-current-operated protective device (RCD)/earth leakage circuit breaker (ELCB) (with overcurrent protection) in the input (primary) circuit of the inverter to protect the wiring. Ensure that the circuit breaker capacity is equivalent to or lower than the recommended capacity.
	Installing an MC in the secondary circuit	If a magnetic contactor (MC) is mounted in the inverter's secondary circuit for switching the motor to commercial power or for any other purpose, ensure that both the inverter and the motor are completely stopped before you turn the MC on or off. Do not connect a magnet contactor united with a surge killer to the inverter's secondary circuit.
	Installing an MC in the primary circuit	Do not turn the magnetic contactor (MC) in the input (primary) circuit on or off more than once an hour as an inverter failure may result. If frequent starts or stops are required during motor operation, use FWD/REV signals or the  /  keys.
	Protecting the motor	The electronic thermal function of the inverter can protect the motor. The operation level and the motor type (general-purpose motor, inverter motor) should be set. For high-speed motors or water-cooled motors, set a small value for the thermal time constant and protect the motor. If you connect the motor thermal relay to the motor with a long wire, a high-frequency current may flow into the wiring stray capacitance. This may cause the relay to trip at a current lower than the set value for the thermal relay. If this happens, lower the carrier frequency or use the output circuit filter (OFL).

Combination with peripheral devices	Discontinuance of power-factor correcting capacitor	Do not mount power-factor correcting capacitors in the inverter's primary circuit. (Use the DC reactor to improve the inverter power factor.) Do not use power-factor correcting capacitors in the inverter output circuit. An overcurrent trip will occur, disabling motor operation.
	Discontinuance of surge killer	Do not connect a surge killer to the inverter's secondary circuit.
	Reducing noise	Use of a filter and shielded wires is typically recommended to satisfy EMC directives.
	Measures against surge currents	If an overvoltage trip occurs while the inverter is stopped or operated under a light load, it is assumed that the surge current is generated by open/close of the phase-advancing capacitor in the power system. * Connect a DC reactor to the inverter.
	Megger test	When checking the insulation resistance of the inverter, use a 500 V megger and follow the instructions contained in Chapter 7, Section 7.4 "Insulation Test."
Wiring	Control circuit wiring length	When using remote control, limit the wiring length between the inverter and operator box to 20 m or less and use twisted pair or shielded cable.
	Wiring length between inverter and motor	If long wiring is used between the inverter and the motor, the inverter will overheat or trip as a result of overcurrent (high-frequency current flowing into the stray capacitance) in the wires connected to the phases. Ensure that the wiring is shorter than 50 m. If this length must be exceeded, lower the carrier frequency or mount an output circuit filter (OFL).
	Wiring size	Select wires with a sufficient capacity by referring to the current value or recommended wire size.
	Wiring type	Do not use one multicore cable in order to connect several inverters with motors.
	Grounding	Securely ground the inverter using the grounding terminal.
Selecting inverter capacity	Driving general-purpose motor	Select an inverter according to the nominal applied motor listed in the standard specifications table for the inverter. When high starting torque is required or quick acceleration or deceleration is required, select an inverter with a capacity one size greater than the standard.
	Driving special motors	Select an inverter that meets the following condition: Inverter rated current > Motor rated current
Transportation and storage	<p>When exporting an inverter built in a panel or equipment, pack them in a previously fumigated wooden crate. Do not fumigate them after packing since some parts inside the inverter may be corroded by halogen compounds such as methyl bromide used in fumigation.</p> <p>When packing an inverter alone for export, use a laminated veneer lumber (LVL).</p> <p>For other transportation and storage instructions, see Chapter 1, Section 1.3 "Transportation" and Section 1.4 "Storage Environment."</p>	

How this manual is organized

This manual is made up of chapters 1 through 11.

Chapter 1 BEFORE USING THE INVERTER

This chapter describes acceptance inspection and precautions for transportation and storage of the inverter.

Chapter 2 MOUNTING AND WIRING OF THE INVERTER

This chapter provides operating environment, precautions for installing the inverter, wiring instructions for the motor and inverter.

Chapter 3 OPERATION USING THE KEYPAD

This chapter describes inverter operation using the keypad. The inverter features three operation modes (Running, Programming and Alarm modes) which enable you to run and stop the motor, monitor running status, set function code data, display running information required for maintenance, and display alarm data.

Chapter 4 OPERATION

This chapter describes preparation to be made before running the motor for a test and practical operation.

Chapter 5 FUNCTION CODES

This chapter provides a list of the function codes. Function codes to be used often and irregular ones are described individually.

Chapter 6 TROUBLESHOOTING

This chapter describes troubleshooting procedures to be followed when the inverter malfunctions or detects an alarm condition. In this chapter, first check whether any alarm code is displayed or not, and then proceed to the troubleshooting items.

Chapter 7 MAINTENANCE AND INSPECTION

This chapter describes inspection, measurement and insulation test which are required for safe inverter operation. It also provides information about periodical replacement parts and guarantee of the product.

Chapter 8 SPECIFICATIONS

This chapter lists specifications including output ratings, control system, external dimensions and protective functions.

Chapter 9 LIST OF PERIPHERAL EQUIPMENT AND OPTIONS

This chapter describes main peripheral equipment and options which can be connected to the FRENIC-Mini series of inverters.

Chapter 10 APPLICATION OF DC REACTOR (DCRs)

This chapter describes a DC reactor that suppresses input harmonic component current.

Chapter 11 COMPLIANCE WITH STANDARDS

This chapter describes standards with which the FRENIC-Mini series of inverters comply.

Icons

The following icons are used throughout this manual.

 **Note** This icon indicates information which, if not heeded, can result in the inverter not operating to full efficiency, as well as information concerning incorrect operations and settings which can result in accidents.

 **Tip** This icon indicates information that can prove handy when performing certain settings or operations.

 This icon indicates a reference to more detailed information.

Table of Contents

Preface	i	Chapter 4 RUNNING THE MOTOR	4-1
■ Safety precautions	ii	4.1 Running the Motor for a Test	4-1
■ Precautions for use	xi	4.1.1 Inspection and preparation prior to the operation	4-1
How this manual is organized	xiv	4.1.2 Turning on power and checking	4-1
Chapter 1 BEFORE USING THE INVERTER	1-1	4.1.3 Preparation before running the motor for a test--Setting function code data	4-2
1.1 Acceptance Inspection	1-1	4.1.4 Test run	4-3
1.2 External View and Terminal Blocks	1-2	4.2 Operation	4-3
1.3 Transportation	1-2	Chapter 5 FUNCTION CODES	5-1
1.4 Storage Environment	1-3	5.1 Function Code Tables	5-1
1.4.1 Temporary storage	1-3	5.2 Overview of Function Codes	5-13
1.4.2 Long-term storage	1-3	Chapter 6 TROUBLESHOOTING	6-1
Chapter 2 MOUNTING AND WIRING OF THE IN- VERTER	2-1	6.1 Before Proceeding with Troubleshooting	6-1
2.1 Operating Environment	2-1	6.2 If No Alarm Code Appears on the LED Monitor	6-3
2.2 Installing the Inverter	2-1	6.2.1 Motor is running abnormally	6-3
2.3 Wiring	2-2	6.2.2 Problems with inverter settings	6-8
2.3.1 Removing the terminal block (TB) covers	2-2	6.3 If an Alarm Code Appears on the LED Monitor	6-9
2.3.2 Terminal arrangement and screw specifications	2-3	6.4 If an Abnormal Pattern Appears on the LED Monitor while No Alarm Code is Displayed	6-19
2.3.3 Recommended wire sizes	2-4	Chapter 7 MAINTENANCE AND INSPECTION	7-1
2.3.4 Wiring precautions	2-6	7.1 Daily Inspection	7-1
2.3.5 Wiring for main circuit terminals and grounding terminals	2-7	7.2 Periodic Inspection	7-1
2.3.6 Replacing the main circuit terminal block (TB) cover	2-13	7.3 Measurement of Electrical Amounts in Main Circuit	7-6
2.3.7 Wiring for control circuit terminals	2-14	7.4 Insulation Test	7-7
2.3.8 Switching of SINK/SOURCE (jumper switch)	2-21	7.5 List of Periodical Replacement Parts	7-8
2.3.9 Installing an RS-485 communications card (option)	2-21	7.6 Inquiries about Product and Guarantee	7-8
2.3.10 Replacing the control circuit terminal block (TB) cover	2-22	7.6.1 When making an inquiry	7-8
2.3.11 Cautions relating to harmonic component, noise, and leakage current	2-23	7.6.2 Product warranty	7-8
Chapter 3 OPERATION USING THE KEYPAD	3-1	Chapter 8 SPECIFICATIONS	8-1
3.1 Keys, Potentiometer, and LED on the Keypad	3-1	8.1 Standard Models	8-1
3.2 Overview of Operation Modes	3-2	8.1.1 Three-phase 200 V class series	8-1
3.2.1 Running mode	3-4	8.1.2 Three-phase 400 V class series	8-2
[1] Monitoring the running status	3-4	8.1.3 Single-phase 200 V class series	8-3
[2] Setting up frequency, etc	3-6	8.1.4 Single-phase 100 V class series	8-4
[3] Running/stopping the motor	3-9	8.2 Models Available on Order	8-5
[4] Jogging (inching) the motor	3-10	8.2.1 EMC filter built-in type	8-5
3.2.2 Programming mode	3-11	8.2.2 Braking resistor built-in type	8-5
[1] Setting function codes - "Data Setting"	3-13	8.3 Common Specifications	8-6
[2] Checking changed function codes - "Data Checking"	3-17	8.4 Terminal Specifications	8-8
[3] Monitoring the running status - "Drive Monitoring"	3-19	8.4.1 Terminal functions	8-8
[4] Checking I/O signal status - "I/O Checking"	3-23	8.4.2 Connection diagram in operation by external signal inputs	8-8
[5] Reading maintenance information - "Maintenance Information"	3-27	8.5 External Dimensions	8-10
[6] Reading alarm information - "Alarm Information"	3-29	8.5.1 Standard models and models available on order (braking resistor built-in type)	8-10
3.2.3 Alarm mode	3-32	8.5.2 Models available on order (EMC filter built-in type)	8-12
		8.6 Protective Functions	8-14
		Chapter 9 LIST OF PERIPHERAL EQUIPMENT AND OPTIONS	9-1



Chapter 10 APPLICATION OF DC REACTORS (DCRs)	10-1
Chapter 11 COMPLIANCE WITH STANDARDS .	11-1
11.1 Compliance with UL Standards and Canadian Standards (cUL certification)....	11-1
11.1.1 General	11-1
11.1.2 Considerations when using FRENIC-Mini in systems to be certified by UL and cUL	11-1
11.2 Compliance with European Standards	11-1
11.3 Compliance with EMC Standards.....	11-2
11.3.1 General	11-2
11.3.2 Recommended installation procedure	11-2
11.3.3 Leakage current of EMC-filter built-in type inverter and onboard EMC-complaint filter	11-5
11.4 Harmonic Component Regulation in the EU	11-7
11.4.1 General comments	11-7
11.4.2 Compliance with the harmonic component regulation.....	11-8
11.5 Compliance with the Low Voltage Directive in the EU	11-8
11.5.1 General	11-8
11.5.2 Points for consideration when using the FRENIC-Mini series in a system to be certified by the Low Voltage Directive in the EU.....	11-8

Chapter 1 BEFORE USING THE INVERTER

1.1 Acceptance Inspection

Unpack the package and check that:

- (1) An inverter and instruction manual (this manual) is contained in the package.
- (2) The inverter has not been damaged during transportation—there should be no dents or parts missing.
- (3) The inverter is the model you ordered. You can check the model name and specifications on the main nameplate. (Main and sub nameplates are attached to the inverter and are located as shown on the following page.)

		
TYPE	FRN1.5C1S-4E	
SOURCE	3PH 380-480V 50/60Hz 5.9A	
OUTPUT	3PH 1.5kW 380-480V 1-400Hz 3.7A 150% 1min	
SER.No.	71A123A0001Z	649
Fuji Electric FA		Made in Japan

(a) Main Nameplate

TYPE	FRN1.5C1S-4E
SER.No.	71A123A0001Z

(b) Sub Nameplate

Figure 1.1 Nameplates

TYPE: Type of inverter

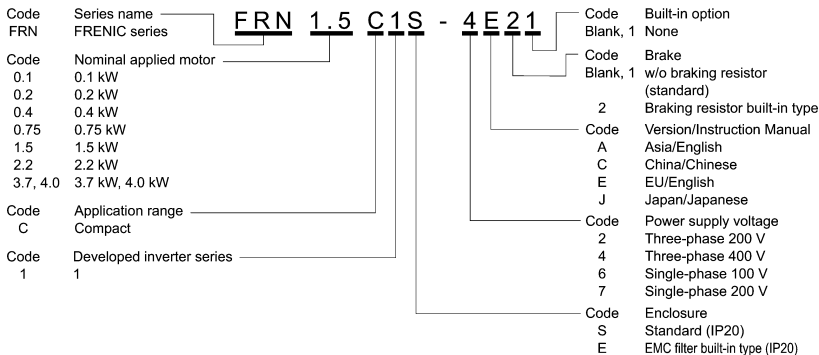

Note: When "None" and "w/o braking resistor (standard)" are selected in the built-in option and brake in the above codes, respectively, the type of inverter is written without the last 2 digits as a standard model.

SOURCE: Number of input phases (three-phase: 3PH, single-phase: 1PH), input voltage, input frequency, input current

OUTPUT: Number of output phases, rated output capacity, rated output voltage, output frequency range, rated output current, overload capacity

SER. No.: Product number

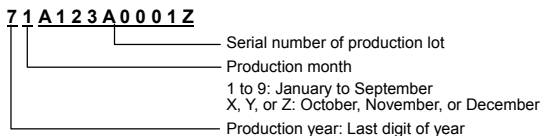

If you suspect the product is not working properly or if you have any questions about your product, contact your Fuji Electric representative.

1.2 External View and Terminal Blocks

(1) External views

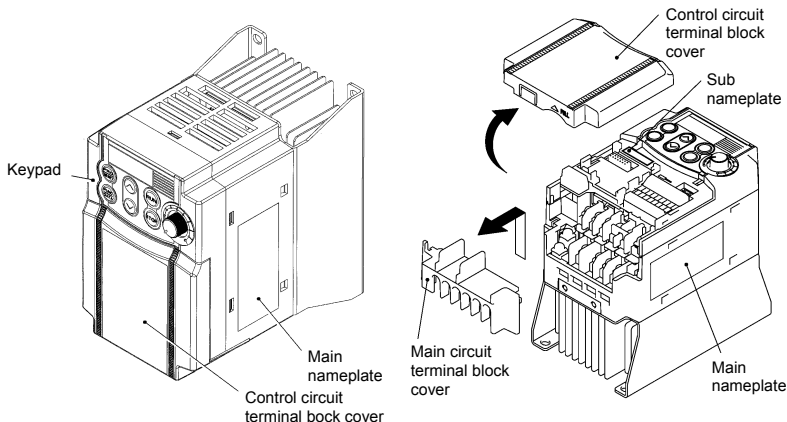
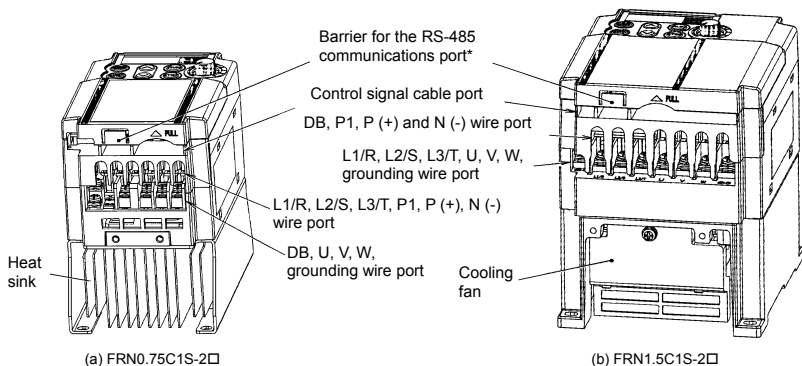

Figure 1.2 External Views of FRENIC-Mini

(2) View of terminals



(* When connecting the RS-485 communications cable, remove the control circuit terminal block cover and cut off the barrier provided in it using nippers.)

Note: A box (□) in the above model names replaces A, C, E, or J depending on the shipping destination.

Figure 1.3 Bottom View of FRENIC-Mini

1.3 Transportation

- When carrying the inverter, always support its bottom at the front and rear sides with both hands. Do not hold covers or individual parts only. You may drop the inverter or break it.
- Avoid applying excessively strong force to the terminal block covers as they are made of plastic and are easily broken.

1.4 Storage Environment

1.4.1 Temporary storage

Store the inverter in an environment that satisfies the requirements listed in Table 1.1.

Table 1.1 Environmental Requirements for Storage and Transportation

Item	Requirements	
Storage temperature ^{*1}	-25 to +70°C	Locations where the inverter is not subject to abrupt changes in temperature that would result in the formation of condensation or ice.
Relative humidity	5 to 95% ^{*2}	
Atmosphere	The inverter must not be exposed to dust, direct sunlight, corrosive or flammable gases, oil mist, vapor, water drops or vibration. The atmosphere can contain only a low level of salt. (0.01 mg/cm ² or less per year)	
Atmospheric pressure	86 to 106 kPa (in storage)	
	70 to 106 kPa (during transportation)	

^{*1} Assuming a comparatively short storage period (e.g., during transportation or the like).

^{*2} Even if the humidity is within the specified requirements, avoid such places where the inverter will be subjected to sudden changes in temperature that will cause condensation to form.

Precautions for temporary storage

- (1) Do not leave the inverter directly on the floor.
- (2) If the environment does not satisfy the specified requirements, wrap the inverter in an airtight vinyl sheet or the like for storage.
- (3) If the inverter is to be stored in an environment with a high level of humidity, put a drying agent (such as silica gel) in the airtight package described in item (2).

1.4.2 Long-term storage

The long-term storage methods for the inverter vary largely according to the environment of the storage site. General storage methods are described below.

- (1) The storage site must satisfy the requirements specified for temporary storage.
However, for storage exceeding three months, the ambient temperature should be within the range from -10 to +30 °C. This is to prevent the electrolytic capacitors in the inverter from deteriorating.
- (2) The inverter must be stored in a package that is airtight to protect it from moisture. Include a drying agent inside the package to maintain the relative humidity inside the package to within 70%.
- (3) If the inverter has been installed in the equipment or control board at a construction site where it may be subjected to humidity, dust or dirt, then remove the inverter and store it in a suitable environment specified in Table 1.1.

Precautions for storage over 1 year

If the inverter will not be powered on for a long time, the property of the electrolytic capacitors may deteriorate. Power the inverters on once a year and keep them on for 30 to 60 minutes. Do not connect the inverters to motors or run the motor.

Chapter 2 MOUNTING AND WIRING OF THE INVERTER

2.1 Operating Environment

Install the inverter in an environment that satisfies the requirements listed in Table 2.1.

Table 2.1 Environmental Requirements

Item	Specifications
Site location	Indoors
Ambient temperature	-10 to +50°C (Note 1)
Relative humidity	5 to 95% (No condensation)
Atmosphere	The inverter must not be exposed to dust, direct sunlight, corrosive gases, flammable gas, oil mist, vapor or water drops. (Note 2) The atmosphere can contain only a low level of salt. (0.01 mg/cm ² or less per year) The inverter must not be subjected to sudden changes in temperature that will cause condensation to form.
Altitude	1,000 m max. (Note 3)
Atmospheric pressure	86 to 106 kPa
Vibration	3 mm (Max. amplitude) 2 to less than 9 Hz 9.8 m/s ² 9 to less than 20 Hz 2 m/s ² 20 to less than 55 Hz 1 m/s ² 55 to less than 200 Hz

Table 2.2 Output Current Derating Factor in Relation to Altitude

Altitude	Output current derating factor
1000 m or lower	1.00
1000 to 1500 m	0.97
1500 to 2000 m	0.95
2000 to 2500 m	0.91
2500 to 3000 m	0.88

(Note 1) When inverters are mounted side-by-side without any gap between them or the NEMA1 kit option is mounted on the inverter, the ambient temperature should be within the range from -10 to +40°C.

(Note 2) Do not install the inverter in an environment where it may be exposed to cotton waste or moist dust or dirt which will clog the heat sink in the inverter. If the inverter is to be used in such an environment, install it in the panel of your system or other dustproof containers.

(Note 3) If you use the inverter in an altitude above 1000 m, you should apply an output current derating factor as listed in Table 2.2.

2.2 Installing the Inverter

(1) Mounting base

The temperature of the heat sink will rise up to approx. 90°C during operation of the inverter, so the inverter should be mounted on a base made of material that can withstand temperatures of this level.

 WARNING
Install the inverter on a base made of metal or other non-flammable material. A fire may result with other material.

(2) Clearances

Ensure that the minimum clearances indicated in Figure 2.1 are maintained at all times. When installing the inverter in the panel of your system, take extra care with ventilation inside the panel as the temperature around the inverter tends to increase.



Figure 2.1 Mounting Direction and Required Clearances

When mounting two or more inverters

When mounting two or more inverters in the same unit or panel, basically lay them out side by side. As long as the ambient temperature is 40°C or lower, inverters can be mounted side by side without any clearance between them. When mounting the inverters necessarily, one above the other, be sure to separate them with a partition plate or the like so that any heat radiating from an inverter will not affect the one(s) above.

(3) Mounting direction

Secure the inverter to the mounting base with four screws or bolts (M4) so that the FRENIC-Mini logo faces outwards. Tighten those screws or bolts perpendicular to the mounting base.

Note Do not mount the inverter upside down or horizontally. Doing so will reduce the heat dissipation efficiency of the inverter and cause the overheat protection function to operate, so the inverter will not run.

⚠ CAUTION

Prevent lint, paper fibers, sawdust, dust, metallic chips, or other foreign materials from getting into the inverter or from accumulating on the heat sink.

This may result in a fire or accident.

2.3 Wiring

Follow the procedure below. (In the following description, the inverter has already been installed.)

2.3.1 Removing the terminal block (TB) covers

(1) Removing the control circuit terminal block (TB) cover

Insert your finger in the cutout (near "PULL") in the bottom of the control circuit TB cover, then pull the cover towards you.

(2) Removing the main circuit terminal block (TB) cover

Hold both sides of the main circuit TB cover between thumb and forefinger and slide it towards you.

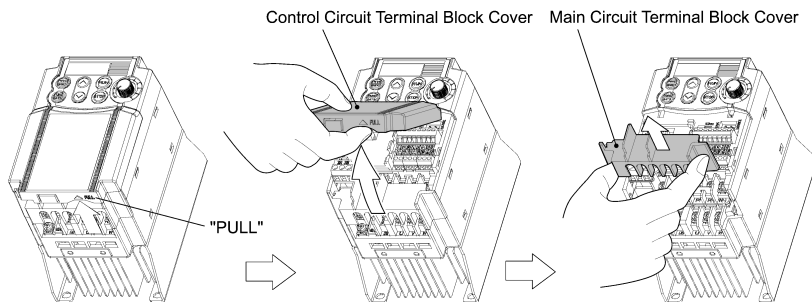



Figure 2.2 Removing the Terminal Block (TB) Covers

2.3.2 Terminal arrangement and screw specifications

The figures below show the arrangement of the main and control circuit terminals which differs according to inverter type. The two terminals prepared for grounding, which are indicated by the symbol  in Figures A to D, make no distinction between the power supply side (primary circuit) and the motor side (secondary circuit).

(1) Arrangement of the main circuit terminals

Table 2.3 Main Circuit Terminals

Power supply voltage	Nominal applied motor (kW)	Inverter type	Terminal screw size	Tightening torque (N·m)	Refer to:
Three-phase 200 V	0.1	FRN0.1C1■-2□	M3.5	1.2	Figure A
	0.2	FRN0.2C1■-2□			
	0.4	FRN0.4C1■-2□			
	0.75	FRN0.75C1■-2□			
	1.5	FRN1.5C1■-2□**			
	2.2	FRN2.2C1■-2□**			
Three-phase 400 V	3.7	FRN3.7C1■-2□**	M4	1.8	Figure B
	0.4	FRN0.4C1■-4□			
	0.75	FRN0.75C1■-4□			
	1.5	FRN1.5C1■-4□**			
	2.2	FRN2.2C1■-4□**			
	3.7	FRN3.7C1■-4□**			
Single-phase 200 V	4.0	FRN4.0C1■-4□**	M3.5	1.2	Figure C
	0.1	FRN0.1C1■-7□			
	0.2	FRN0.2C1■-7□			
	0.4	FRN0.4C1■-7□			
	0.75	FRN0.75C1■-7□			
	1.5	FRN1.5C1■-7□			
Single-phase 200 V	2.2	FRN2.2C1■-7□	M4	1.8	Figure D
	0.1	FRN0.1C1■-6□			
Single-phase 100 V	0.2	FRN0.2C1■-6□	M3.5	1.2	Figure C
	0.4	FRN0.4C1■-6□			
	0.75	FRN0.75C1■-6□			
	0.75	FRN0.75C1■-6□			

Note 1) A box (■) in the above table replaces S or E depending on the enclosure.

2) A box (□) in the above table replaces A, C, E, or J depending on the shipping destination.

3) Asterisks (**) in the above table denote the following:

21: Braking resistor built-in type, None: Standard

Figure A

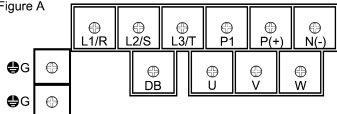

Figure B

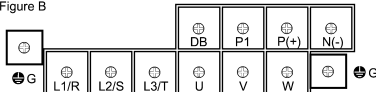

Figure C

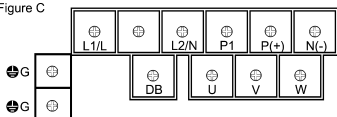
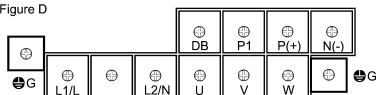
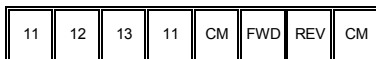
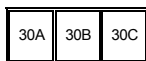
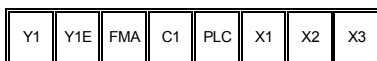

Figure D





(2) Arrangement of the control circuit terminals (common to all FRENIC-Mini models)



Screw size: M2 Tightening torque: 0.2 N·m

Screw size: M2.5 Tightening torque: 0.4 N·m

Table 2.4 Control Circuit Terminals

Terminal	Screwdriver to be used	Allowable wire size	Bared wire length	Dimension of openings in the control circuit terminals for ferrule*
				
30A, 30B, 30C	Phillips screwdriver (JIS standard) No.1 screw tip	AWG22 to AWG18 (0.34 to 0.75 mm ²)	6 to 8 mm	2.7 mm (W) x 1.8 mm (H)
Others	Phillips screwdriver for precision machinery (JCIS standard) No.0 screw tip	AWG24 to AWG18 (0.25 to 0.75 mm ²)	5 to 7 mm	1.7 mm (W) x 1.6 mm (H)

* Manufacturer of ferrules: WAGO Company of Japan, Ltd. Refer to Table 2.5.

Table 2.5 Recommended Ferrule Terminals

Screw size	Wire size	Type (216-□□□)			
		With insulated collar		Without insulated collar	
		Short type	Long type	Short type	Long type
M2	AWG24 (0.25 mm ²)	321	301	151	131
	AWG22 (0.34 mm ²)	322	302	152	132
M2 or M2.5	AWG20 (0.50 mm ²)	221	201	121	101
	AWG18 (0.75 mm ²)	222	202	122	102

The length of bared wires to be inserted into ferrule terminals is 5.0 mm or 8.0 mm for the short or long type, respectively.

The following crimping tool is recommended: Variocrimp 4 (Part No.: 206-204).

2.3.3 Recommended wire sizes

Table 2.6 lists the recommended wire sizes. The recommended wire sizes for the main circuits for an ambient temperature of 50°C are indicated for two types of wire: HIV single wire (for 75°C) (before a slash (/)) and IV single wire (for 60°C) (after a slash (/)),

Table 2.6 Recommended Wire Sizes

Power supply voltage	Nominal applied motor (kW)	Inverter type	Recommended wire size (mm ²) ^{*1}					Control circuit	
			Main circuit						
			Main circuit power input [L1/R, L2/S, L3/T] [L1/L, L2/N] Grounding (G)		Inverter output [U, V, W]	DCR [P1, P (+)]	Braking resistor [P (+), DB]		
			w/ DCR	w/o DCR ^{*2}					
Three-phase 200 V	0.1	FRN0.1C1■-2□	2.0 / 2.0 (2.5)	2.0 / 2.0 (2.5)	2.0 / 2.0 (2.5)	2.0 / 2.0 (2.5)	2.0 / 2.0 (2.5)		
	0.2	FRN0.2C1■-2□							
	0.4	FRN0.4C1■-2□							
	0.75	FRN0.75C1■-2□							
	1.5	FRN1.5C1■-2□**							
	2.2	FRN2.2C1■-2□**							
3.7	FRN3.7C1■-2□**	2.0 / 5.5 (2.5)	2.0 / 3.5 (2.5)	2.0 / 3.5 (2.5)					
Three-phase 400 V	0.4	FRN0.4C1■-4□	2.0 / 2.0 (2.5)	2.0 / 2.0 (2.5)	2.0 / 2.0 (2.5)	2.0 / 2.0 (2.5)	2.0 / 2.0 (2.5)		
	0.75	FRN0.75C1■-4□							
	1.5	FRN1.5C1■-4□**							
	2.2	FRN2.2C1■-4□**							
	3.7 4.0	FRN3.7C1■-4□** FRN4.0C1■-4□**							
Single-phase 200 V	0.1	FRN0.1C1■-7□	2.0 / 2.0 (2.5)	2.0 / 2.0 (2.5)	2.0 / 2.0 (2.5)	2.0 / 2.0 (2.5)	2.0 / 2.0 (2.5)		
	0.2	FRN0.2C1■-7□							
	0.4	FRN0.4C1■-7□							
	0.75	FRN0.75C1■-7□							
	1.5	FRN1.5C1■-7□						2.0 / 3.5 (4.0)	
	2.2	FRN2.2C1■-7□						2.0 / 3.5 (4.0)	3.5 / 5.5 (6.0)
Single-phase 100 V	0.1	FRN0.1C1■-6□	2.0 / 2.0	2.0 / 2.0	2.0 / 2.0	*3	2.0 / 2.0		
	0.2	FRN0.2C1■-6□							
	0.4	FRN0.4C1■-6□							
	0.75	FRN0.75C1■-6□						2.0 / 3.5	

DCR: DC reactor

*1 Use crimp terminals covered with an insulated sheath or insulating tube. Recommended wire sizes are for HIV/IV (PVC in the EU).

*2 Wire sizes are calculated on the basis of input RMS current under the condition that the power supply capacity and impedance are 500 kVA (50 kVA for single-phase 100 V class series) and 5%, respectively.

*3 For single-phase 100 V class series of inverters, use the same size of wires as used for the main circuit power input. Insert the DC reactor (DCR) in either of the primary power input lines. Refer to Chapter 10 for more details.

Note 1) A box (■) in the above table replaces S or E depending on the enclosure.

2) A box (□) in the above table replaces A, C, E, or J depending on the shipping destination.

3) Asterisks (**) in the above table denote the following:

21: Braking resistor built-in type, None: Standard

2.3.4 Wiring precautions

Follow the rules below when performing wiring for the inverter.

- (1) Make sure that the source voltage is within the rated voltage range specified on the nameplate.
- (2) Be sure to connect the power wires to the main circuit power input terminals L1/R, L2/S and L3/T (for three-phase voltage input) or L1/L and L2/N (for single-phase voltage input) of the inverter. If the power wires are connected to other terminals, the inverter will be damaged when the power is turned on.
- (3) Always connect the grounding terminal to prevent electric shock, fire or other disasters and to reduce electric noise.
- (4) Use crimp terminals covered with insulated sleeves for the main circuit terminal wiring to ensure a reliable connection.
- (5) Keep the power supply wiring (primary circuit) and motor wiring (secondary circuit) of the main circuit, and control circuit wiring as far away as possible from each other.

WARNING

- When wiring the inverter to the power source, insert a recommended molded case circuit breaker (MCCB) or residual-current-operated protective device (RCD)/earth leakage circuit breaker (ELCB) (with overcurrent protection) in the path of power lines. Use the devices within the related current range.
- Use wires in the specified size.
Otherwise, fire could occur.
- Do not use one multicore cable in order to connect several inverters with motors.
- Do not connect a surge killer to the inverter's output (secondary) circuit.
Doing so could cause fire.
- Be sure to connect the grounding wires without fail.
Otherwise, electric shock or fire could occur.
- Qualified electricians should carry out wiring.
- Be sure to perform wiring after turning the power off.
- Ground the inverter following Class C or Class D specifications or national/local electric code, depending on the input voltage of the inverter.
Otherwise, electric shock could occur.
- Be sure to perform wiring after installing the inverter body.
Otherwise, electric shock or injuries could occur.
- Ensure that the number of input phases and the rated voltage of the product match the number of phases and the voltage of the AC power supply to which the product is to be connected.
Otherwise, fire or an accident could occur.
- Do not connect the power source wires to output terminals (U, V, and W).
- Do not connect a braking resistor to between terminals P (+) and N (-), P1 and N (-), P (+) and P1, DB and N (-), or P1 and DB.
Doing so could cause fire or an accident.

2.3.5 Wiring for main circuit terminals and grounding terminals

Follow the procedure below. Figure 2.3 illustrates the wiring procedure with peripheral equipment.

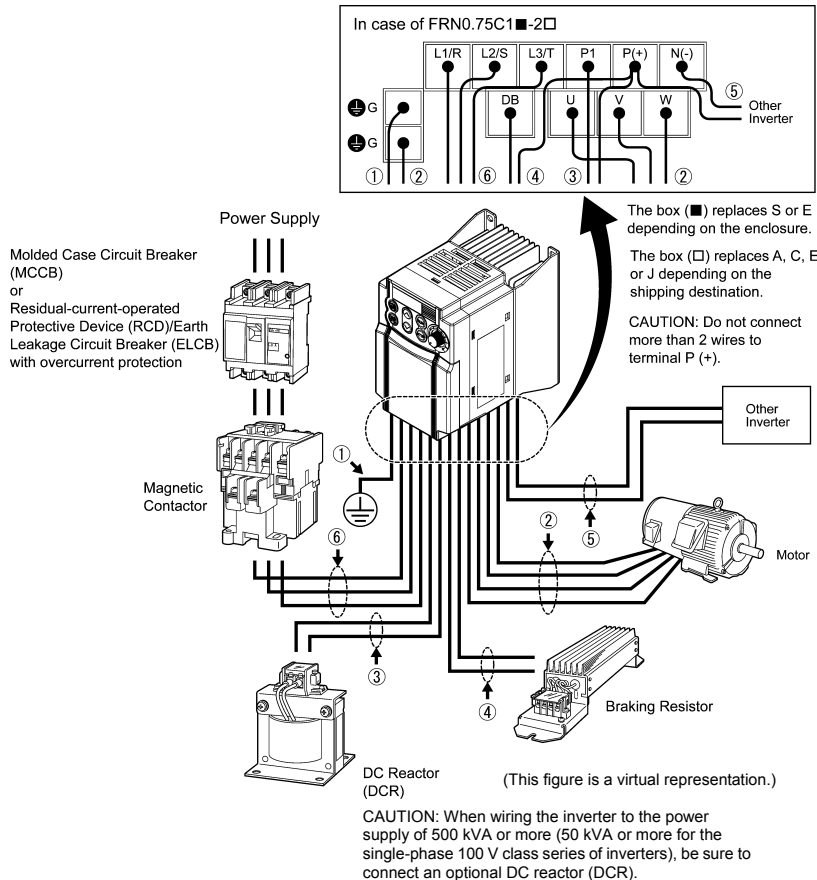
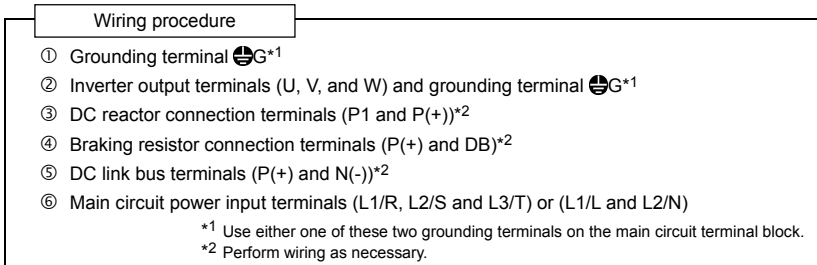

Figure 2.3 Wiring Procedure for Peripheral Equipment

The wiring procedure for the FRN0.75C1S-2□ is given below as an example. For other inverter types, perform wiring in accordance with their individual terminal arrangement. (Refer to page 2-3.)

① Grounding terminal (⚡G)

Be sure to ground either of the two grounding terminals for safety and noise reduction. It is stipulated by the Electric Facility Technical Standard that all metal frames of electrical equipment must be grounded to avoid electric shock, fire and other disasters.

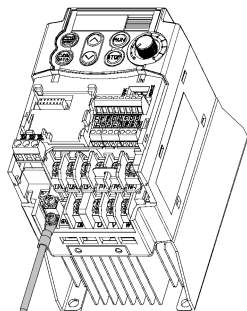

Figure 2.4 Grounding Terminal Wiring

Grounding terminals should be grounded as follows:

- 1) Connect the grounding terminal of the 200 V or 400 V class series of inverters to a ground electrode on which class D or C grounding work has been completed, respectively, in conformity to the Electric Facility Technical Standard.
- 2) Connect a thick grounding wire with a large surface area and which meets the grounding resistance requirements listed in Table 2.7. Keep the wiring length as short as possible.

Table 2.7 Grounding Stipulated in the Electric Facility Technical Standard

Supply voltage	Grounding work class	Grounding resistance
Three-phase 200 V Single-phase 200 V Single-phase 100 V	Class D	100Ω or less
Three-phase 400 V	Class C	10Ω or less

Note Above requirements are for Japan. Ground the inverter according to your national or local Electric code requirements.

② Inverter output terminals, U, V, W and grounding terminal (⚡G)

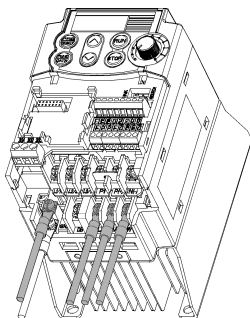
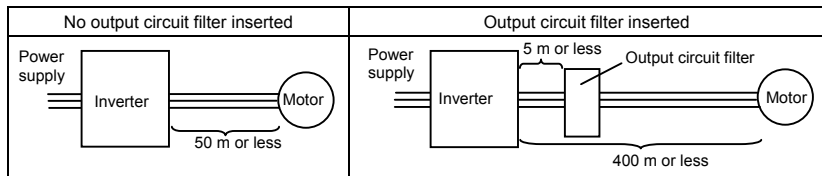

Figure 2.5 Inverter Output Terminal Wiring

- 1) Connect the three wires of the three-phase motor to terminals U, V, and W, aligning phases each other.
- 2) Connect the grounding wire of terminals U, V, and W to the grounding terminal (⚡G).

Note

- The wiring length between the inverter and motor should not exceed 50 m. If the wiring length exceeds 50 m, it is recommended that an output circuit filter (option) be inserted.
- Do not use one multicore cable to connect several inverters with motors.



Note

- Do not connect a power factor correcting capacitor or surge absorber to the inverter's output lines (secondary circuit).
- If the wiring length is long, the stray capacitance between the wires will increase, resulting in an outflow of the leakage current. It will activate the overcurrent protection, increase the leakage current, or will not assure the accuracy of the current display. In the worst case, the inverter could be damaged.
- If more than one motor is to be connected to a single inverter, the wiring length should be the length of the wires to the motors.

Note

Driving 400 V series motor

- If a thermal relay is installed in the path between the inverter and the motor to protect the motor from overheating, the thermal relay may malfunction even with a wiring length shorter than 50 m. In this situation, add an output circuit filter (option) or lower the carrier frequency (Function code F26: Motor sound (Sound tune)).
- If the motor is driven by a PWM-type inverter, surge voltage that is generated by switching the inverter component may be superimposed on the output voltage and may be applied to the motor terminals. Particularly if the wiring length is long, the surge voltage may deteriorate the insulation resistance of the motor. Consider any of the following measures.
 - Use a motor with insulation that withstands the surge voltage. (All Fuji standard motors feature insulation that withstands the surge voltage.)
 - Connect an output circuit filter (option) to the output terminals (secondary circuits) of the inverter.
 - Minimize the wiring length between the inverter and motor (10 to 20 m or less).

Note

Wiring length for EMC filter built-in type

- When the wiring length between the inverter and motor exceeds 10 m, the filter circuit may be overheated and damaged due to increase of leakage current. To reduce the leakage current, set the motor sound (carrier frequency) to 2 kHz or below with function code F26.

③ DC reactor terminals, P1 and P (+)

- 1) Remove the jumper bar from terminals P1 and P(+).
- 2) Connect a DC reactor (option) to terminals P1 and P(+).

Note

- The wiring length should be 10 m or below.
- If both a DC reactor and a braking resistor are to be connected to the inverter, secure both wires of the DC reactor and braking resistor together to terminal P(+). (Refer to item ④ on the next page.)
- Do not remove the jumper bar if a DC reactor is not going to be used.

WARNING

When wiring the inverter to the power supply of 500 kVA or more (50 kVA or more for the single-phase 100 V class series of inverters), be sure to connect an optional DC reactor (DCR).

Otherwise, fire could occur.

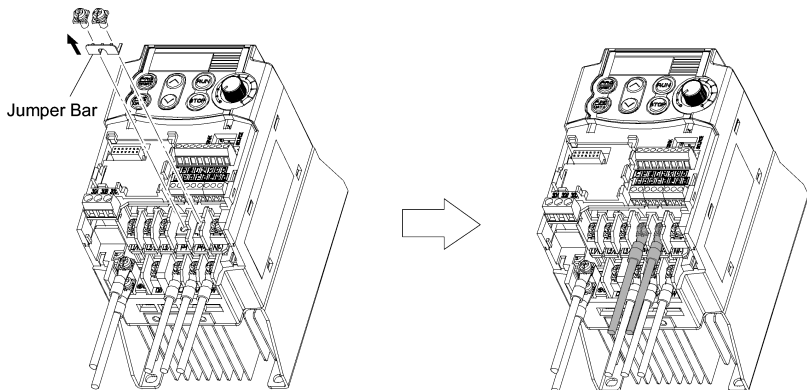

Figure 2.6 DC Reactor Connection

④ Braking resistor terminals, P(+) and DB

- 1) Connect terminals P and DB of a braking resistor to terminals P(+) and DB on the main circuit terminal block. (For the braking resistor built-in type, refer to the next page.)
- 2) When using an external braking resistor, arrange the inverter and braking resistor to keep the wiring length to 5 m or less and twist the two wires or route them together in parallel.

Note Do not connect a braking resistor to any inverter with a rated capacity of 0.2 kW or below. (Even if connected, the braking resistor will not work.)

WARNING

Never insert a braking resistor between terminals P(+) and N(-), P1 and N(-), P(+) and P1, DB and N(-), or P1 and DB.

Doing so could cause fire.

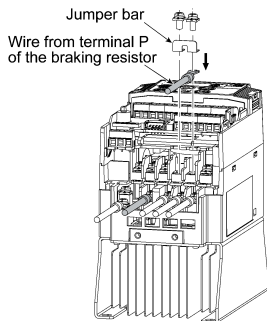

Figure 2.7 Braking Resistor Connection without DC Reactor

When a DC reactor is not to be connected together with the braking resistor

- 1) Remove the screws from terminals P(+) and P1, together with the jumper bar.
- 2) Connect the wire from terminal P of the braking resistor to terminal P(+) of the inverter and put the jumper bar back into place. Then secure the wire and jumper bar with the screw.
- 3) Tighten the screw of terminal P1 on the jumper bar.
- 4) Connect the wire from terminal DB of the braking resistor to the DB of the inverter.

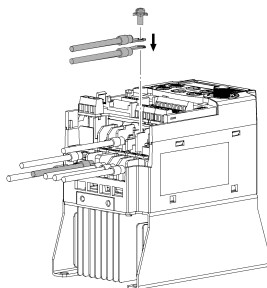

Figure 2.8 Braking Resistor Connection with DC Reactor

When connecting a DC reactor together with the braking resistor

- 1) Remove the screw from terminal P(+).
- 2) Overlap the DC reactor wire and braking resistor wire (P) as shown at left and then secure them to terminal P(+) of the inverter with the screw.
- 3) Connect the wire from terminal DB of the braking resistor to terminal DB of the inverter.
- 4) Do not use the jumper bar.

When using a braking resistor built-in type

A built-in braking resistor is connected to terminals P(+) and DB at the factory as shown below.

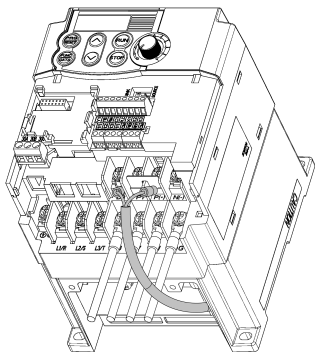

Figure 2.9 Built-in Braking Resistor Connection

(This example shows the braking resistor built-in type FRN1.5C1S-2□21)

Note: A box (□) in the above model name replaces A, C, E, or J depending on the shipping destination.

If you want to connect a DC reactor together with the built-in braking resistor, follow the instructions given on the previous page.



- If both wires of the built-in braking resistor have been disconnected, you may connect them to terminals P(+) and DB in either combination.
- The braking resistor built-in type is available only in three-phase 200 V and three-phase 400 V models of 1.5 kW or more.

WARNING

Never insert a braking resistor between terminals P(+) and N(-), P1 and N(-), P(+) and P1, DB and N(-), or P1 and DB.

Doing so could cause fire.

⑤ DC link bus terminals, P (+) and N (-)

These are provided for the DC link bus powered system. Connect these terminals with terminals P(+) and N (-) of other inverters.



Consult your Fuji Electric representative if these terminals are to be used.

⑥ **Main circuit power input terminals, L1/R, L2/S, and L3/T (for three-phase voltage input) or L1/L and L2/N (for single-phase voltage input)**

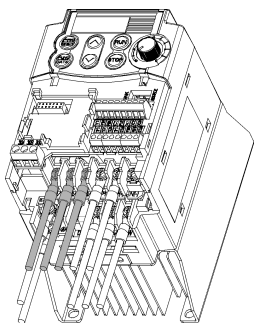

Figure 2.10 Main Circuit Power Input Terminal Connection

- 1) For safety, make sure that the molded case circuit breaker (MCCB) or magnetic contactor (MC) is turned off before wiring the main circuit power input terminals.
- 2) Connect the main circuit power supply wires (L1/R, L2/S and L3/T or L1/L and L2/N) to the input terminals of the inverter via an MCCB or residual-current-operated protective device (RCD)/earth leakage circuit breaker (ELCB)*, and MC if necessary.

It is not necessary to align phases of the power supply wires and the input terminals of the inverter with each other.

* With overcurrent protection

Tip It is recommended that a magnetic contactor be inserted that can be manually activated. This is to allow you to disconnect the inverter from the power supply in an emergency (e.g., when the protective function is activated) so as to prevent a failure or accident from causing the secondary problems.

2.3.6 Replacing the main circuit terminal block (TB) cover

- 1) As shown in Figure 2.11, pull out the wires from the main circuit terminals in parallel.
- 2) Hold both sides of the main circuit TB cover between thumb and forefinger and slide it back into place. Pull the wires out through the grooves of the main circuit TB cover.

Note Replace the main circuit TB cover, taking care not to apply any stress to the wires. Applying stress to the wires will impose a mechanical force on the screws on the main circuit terminals, which may loosen the screws.

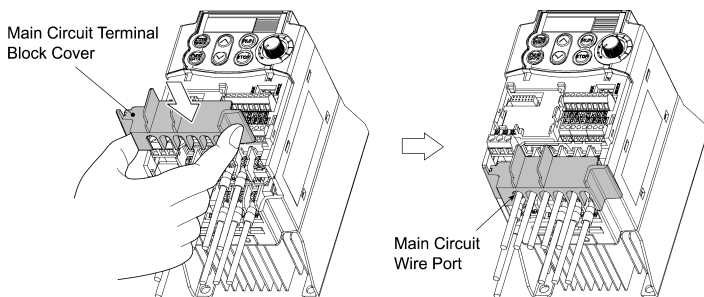

Figure 2.11 Putting Back the Main Circuit Terminal Block (TB) Cover

2.3.7 Wiring for control circuit terminals

WARNING

In general, sheaths and covers of the control signal cables and wires are not specifically designed to withstand a high electric field (i.e., reinforced insulation is not applied). Therefore, if a control signal cable or wire comes into direct contact with a live conductor of the main circuit, the insulation of the sheath or the cover might break down, which would expose the signal wire to a high voltage of the main circuit. Make sure that the control signal cables and wires will not come into contact with live conductors of the main circuit.

Failure to observe these precautions could cause electric shock and/or an accident.

CAUTION

Noise may be emitted from the inverter, motor and wires.

Implement appropriate measure to prevent the nearby sensors and devices from malfunctioning due to such noise.

An accident could occur.

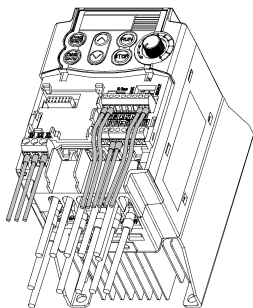

Figure 2.12 Example of Control Circuit Wiring

Table 2.8 lists the symbols, names and functions of the control circuit terminals. The wiring to the control circuit terminals differs depending upon the setting of the function codes, which reflects the use of the inverter.

Put back the main circuit TB cover and then connect wires to the control circuit terminals. As shown in Figure 2.12, pull the wires out through the guides on the main circuit TB cover. Route these wires correctly to reduce the influence of noise, referring to the notes on the following pages.

Table 2.8 Symbols, Names and Functions of the Control Circuit Terminals

Classification	Symbol	Name	Functions
Analog input	[13]	Potentiometer power supply	Power supply (+10 VDC) for frequency command potentiometer (Potentiometer: 1 to 5 k Ω) Allowable output current: 10 mA A potentiometer of 1/2 W rating or more should be connected.
	[12]	Voltage input	(1) The frequency is commanded according to the external analog input voltage. 0 to +10 (VDC)/0 to 100 (%) (Normal mode operation) +10 to 0 (VDC)/0 to 100 (%) (Inverse mode operation) (2) Used for reference signal (PID process command) or PID feedback signal. (3) Used as additional auxiliary setting for various main frequency commands. * Input impedance: 22 k Ω * Allowable maximum input voltage is +15 VDC. If the input voltage is +10 VDC or more, the inverter will limit it at +10 VDC.
	[C1]	Current input	(1) The frequency is commanded according to the external analog input current. +4 to +20 (mA DC)/0 to 100 (%) (Normal mode operation) +20 to +4 (mA DC)/0 to 100 (%) (Inverse mode operation) (2) Used for reference signal (PID process command) or PID feedback signal. (3) Connects PTC (Positive Temperature Coefficient) thermistor for motor protection. (4) Used as additional auxiliary setting to various main frequency commands. * Input impedance: 250 Ω * Allowable input current is +30 mA DC. If the input current exceeds +20 mA DC, the inverter will limit it at +20 mA DC.
	[11]	Analog common	Common terminal for analog input and output signals This terminal is electrically isolated from terminals [CM] and [Y1E].

Classification	Symbol	Name	Functions
Analog input			<p>- Since weak analog signals are handled, these signals are especially susceptible to the external noise effects. Route the wiring as short as possible (within 20 m) and use shielded wires. In principle, ground the shielding layer of the shielded wires; if effects of external inductive noises are considerable, connection to terminal [11] may be effective. As shown in Figure 2.13, ground the single end of the shield to enhance the shielding effect.</p> <p>- Use a twin contact relay for weak signals if the relay is used in the control circuit. Do not connect the relay's contact to terminal [11].</p> <p>- When the inverter is connected to an external device outputting the analog signal, a malfunction may be caused by electric noise generated by the inverter. If this happens, according to the circumstances, connect a ferrite core (a toroidal core or an equivalent) to the device outputting the analog signal and/or connect a capacitor having the good cut-off characteristics for high frequency between control signal wires as shown in Figure 2.14.</p> <p>- Do not apply a voltage of +7.5 VDC or higher to terminal [C1]. Doing so could damage the internal control circuit.</p>
			
Figure 2.13 Connection of Shielded Wire	Figure 2.14 Example of Electric Noise Prevention		

Table 2.8 Continued

Classification	Symbol	Name	Functions																							
Digital input	[X1]	Digital input 1	<p>(1) The various signals such as coast-to-stop, alarm from external equipment, and multi-frequency selection can be assigned to terminals [X1] to [X3], [FWD] and [REV] by setting function codes E01 to E03, E98, and E99. For details, refer to Chapter 5, Section 5.2 "Overview of Function Codes."</p> <p>(2) Input mode, i.e. Sink/Source, is changeable by using the internal jumper switch.</p> <p>(3) Switches the logic value (1/0) for ON/OFF of the terminals between [X1] to [X3], [FWD] or [REV], and [CM]. If the logic value for ON between [X1] and [CM] is 1 in the normal logic system, for example, OFF is 1 in the negative logic system and vice versa.</p> <p>(4) The negative logic signaling cannot be applicable to [FWD] and [REV].</p> <p>Digital input circuit specifications</p>  <table border="1" data-bbox="657 509 989 797"> <thead> <tr> <th>Item</th> <th>Min.</th> <th>Max.</th> </tr> </thead> <tbody> <tr> <td rowspan="2">Operation voltage (SINK)</td> <td>ON level</td> <td>0 V</td> <td>2 V</td> </tr> <tr> <td>OFF level</td> <td>22 V</td> <td>27 V</td> </tr> <tr> <td rowspan="2">Operation voltage (SOURCE)</td> <td>ON level</td> <td>22 V</td> <td>27 V</td> </tr> <tr> <td>OFF level</td> <td>0 V</td> <td>2 V</td> </tr> <tr> <td>Operation current at ON (Input Voltage at 0 V)</td> <td>2.5 mA</td> <td>5 mA</td> </tr> <tr> <td>Allowable leakage current at OFF</td> <td>-</td> <td>0.5 mA</td> </tr> </tbody> </table>	Item	Min.	Max.	Operation voltage (SINK)	ON level	0 V	2 V	OFF level	22 V	27 V	Operation voltage (SOURCE)	ON level	22 V	27 V	OFF level	0 V	2 V	Operation current at ON (Input Voltage at 0 V)	2.5 mA	5 mA	Allowable leakage current at OFF	-	0.5 mA
	Item	Min.		Max.																						
	Operation voltage (SINK)	ON level		0 V	2 V																					
		OFF level		22 V	27 V																					
	Operation voltage (SOURCE)	ON level		22 V	27 V																					
OFF level		0 V	2 V																							
Operation current at ON (Input Voltage at 0 V)	2.5 mA	5 mA																								
Allowable leakage current at OFF	-	0.5 mA																								
[X2]	Digital input 2																									
[X3]	Digital input 3																									
[FWD]	Forward operation command																									
[REV]	Reverse operation command																									
[PLC]	PLC signal power	Connects to PLC output signal power supply. Rated voltage: +24 VDC (Allowable range: +22 to +27 VDC), Max. 50 mA This terminal serves also as a transistor output one.																								
[CM]	Digital common	Common terminal for digital input signals This terminal is electrically isolated from terminals [11] and [Y1E].																								

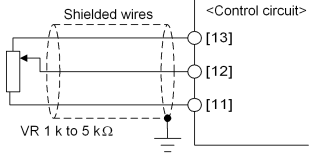
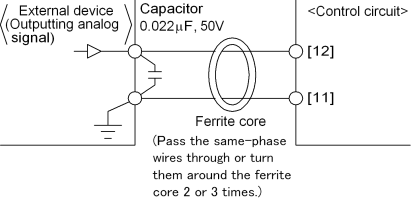
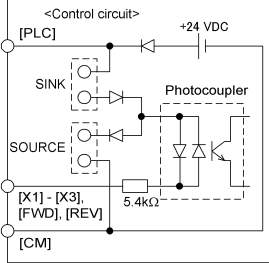

Classification	Symbol	Name	Functions
Digital input		Turning on or off [X1], [X2], [X3], [FWD], or [REV] using a relay contact	
		<p>Figure 2.15 shows two examples of a circuit that turns on or off control signal input [X1], [X2], [X3], [FWD], or [REV] using a relay contact. Circuit (a) has a connecting jumper applied to SINK, whereas circuit (b) has one that is applied to SOURCE.</p> <p>Note: To configure this kind of Fuji circuit, use a highly reliable relay (Recommended product: Fuji control relay Model HH54PW.)</p>	
			
(a) With a jumper applied to SINK		(b) With a jumper applied to SOURCE	
Figure 2.15 Circuit Configuration Using a Relay Contact			
Turning on or off [X1], [X2], [X3], [FWD], or [REV] using a programmable logic controller (PLC)			
<p>Figure 2.16 shows two examples of a circuit that turns on or off control signal input [X1], [X2], [X3], [FWD], or [REV] using a programmable logic controller (PLC). Circuit (a) has a connecting jumper applied to SINK, whereas circuit (b) has one that is applied to SOURCE.</p> <p>In circuit (a) below, short-circuiting or opening the transistor's open collector circuit in the PLC using an external power source turns on or off control signal [X1], [X2], [X3], [FWD], or [REV]. When using this type of circuit, observe the following:</p> <ul style="list-style-type: none"> - Connect the + node of the external power source (which should be isolated from the PLC's power) to terminal [PLC] of the inverter. - Do not connect terminal [CM] of the inverter to the common terminal of the PLC. 			
			
(a) With a jumper applied to SINK		(b) With a jumper applied to SOURCE	
Figure 2.16 Circuit Configuration Using a PLC			
 For details about the jumper setting, refer to Section 2.3.8 "Switching of SINK/SOURCE (jumper switch)."			

Table 2.8 Continued

Classification	Symbol	Name	Functions														
Analog output	[FMA]	Analog monitor	<p>The monitor signal for analog DC voltage (0 to +10 VDC) is output. The signal functions can be selected from the following with function code F31.</p> <ul style="list-style-type: none"> - Output frequency (before slip compensation) - Output frequency (after slip compensation) - Output current - Output voltage - Input power - PID feedback amount - DC link bus voltage - Calibration <p>*Input impedance of external device: Min. 5 kΩ</p>														
	[11]	Analog common	<p>Common terminal for analog input and output signals</p> <p>This terminal is electrically isolated from terminals [CM] and [Y1E].</p>														
Transistor output	[Y1]	Transistor output	<p>(1) Various signals such as inverter running, speed/freq. arrival and overload early warning can be assigned to the terminal [Y1] by setting function code E20. Refer to Chapter 5, Section 5.2 "Overview of Function Codes" for details.</p> <p>(2) Switches the logic value (1/0) on ON/OFF of the terminals between [Y1] and [Y1E]. If the logic value for ON between [Y1] and [Y1E] is 1 in the normal logic system, for example, OFF is 1 in the negative logic system and vice versa.</p> <p>Digital input circuit specification</p>  <table border="1" data-bbox="668 706 973 902"> <thead> <tr> <th colspan="2">Item</th> <th>Max.</th> </tr> </thead> <tbody> <tr> <td rowspan="2">Operation voltage</td> <td>ON level</td> <td>2 V</td> </tr> <tr> <td>OFF level</td> <td>27 V</td> </tr> <tr> <td colspan="2">Maximum load current at ON</td> <td>50 mA</td> </tr> <tr> <td colspan="2">Leakage current at OFF</td> <td>0.1 mA</td> </tr> </tbody> </table> <p>Figure 2.17 shows examples of connection between the control circuit and a PLC.</p> <p>Note</p> <ul style="list-style-type: none"> - Check the polarity of the external power inputs. - When connecting a control relay, first connect a surge-absorbing diode across the coil of the relay. 	Item		Max.	Operation voltage	ON level	2 V	OFF level	27 V	Maximum load current at ON		50 mA	Leakage current at OFF		0.1 mA
	Item		Max.														
	Operation voltage	ON level	2 V														
OFF level		27 V															
Maximum load current at ON		50 mA															
Leakage current at OFF		0.1 mA															
[PLC]	Transistor output power	<p>Power source of +24 VDC to be fed to the transistor output circuit load (50mA at maximum).</p> <p>To enable the source, it is necessary to short-circuit between terminals [Y1E] and [CM].</p> <p>Can also be used as a 24 VDC power source.</p> <p>This terminal serves also as a digital input one.</p>															
[Y1E]	Transistor output common	<p>Common terminal for transistor output signal</p> <p>This terminal is electrically isolated from terminals [CM] and [11].</p>															

Classification	Symbol	Name	Functions
Transistor output	Tip ■ Connecting Programmable Controller (PLC) to Terminal [Y1]		
	Figure 2.18 shows two examples of circuit connection between the transistor output of the inverter's control circuit and a PLC. In example (a), the input circuit of the PLC serves as the sink for the control circuit, whereas in example (b), it serves as the source for the control circuit.		
	 <p>(a) PLC serving as Sink</p> <p>(b) PLC serving as Source</p> <p>Figure 2.18 Connecting PLC to Control Circuit</p>		
Relay contact output	[30A], [30B], [30C]	Alarm relay output (for any fault)	<ol style="list-style-type: none"> (1) Outputs a contact signal (SPDT) when a protective function has been activated to stop the motor. Contact rating: 250 VAC 0.3A $\cos \phi = 0.3$ +48 VDC, 0.5A (2) A command similar to terminal [Y1] can be selected for the transistor output signal and use it for signal output. (3) Switching of the normal/negative logic output is applicable to the following two contact outputs: "Terminals [30A] and [30C] are short-circuited for ON signal output" or "the terminals [30B] and [30C] are short-circuited (non-excite) for ON signal output."
Communication	RS-485 port*	RS-485 communications I/O	<ol style="list-style-type: none"> (1) Used to connect the inverter with PC or PLC using RS-485 port. (2) Used to connect the inverter with the remote keypad. The inverter supplies the power to the remote keypad through the extension cable for remote keypad.

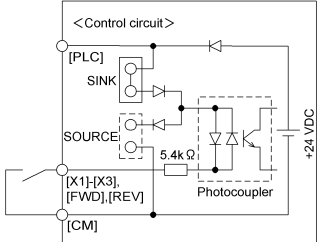
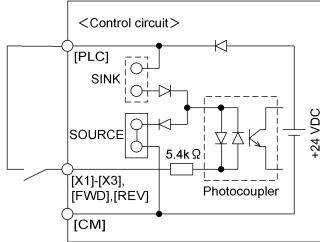
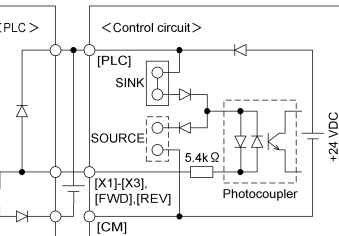
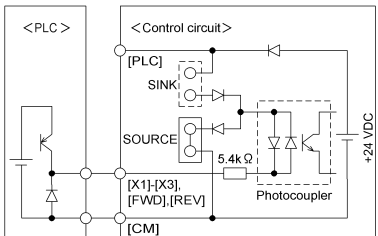
* This terminal can be used with standard inverters equipped with an RS-485 Communications Card (option).

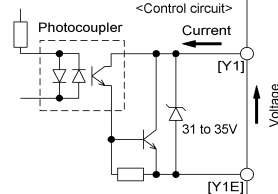
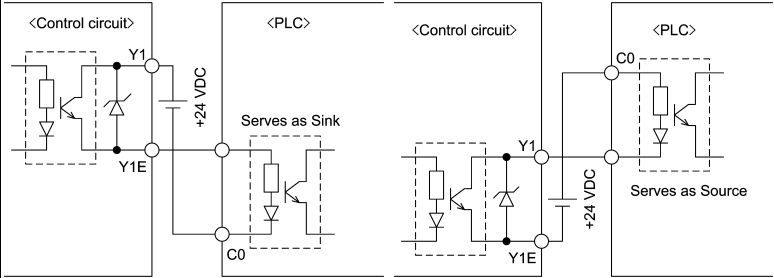
- Note**
- Route the wiring of the control terminals as far from the wiring of the main circuit as possible. Otherwise electric noise may cause malfunctions.
 - Fix the control circuit wires inside the inverter to keep them away from the live parts of the main circuit (such as the terminal block of the main circuit).

2.3.8 Switching of SINK/SOURCE (jumper switch)

⚠ WARNING

Before changing the jumper switch, wait for at least five minutes after the power has been turned off, then check that the DC link bus voltage between the terminals P (+) and N (-) does not exceed the safety voltage (+25 VDC) using a multimeter.

An electric shock may result if this warning is not heeded as there may be some residual electric charge in the DC link bus capacitor even after the power has been turned off.

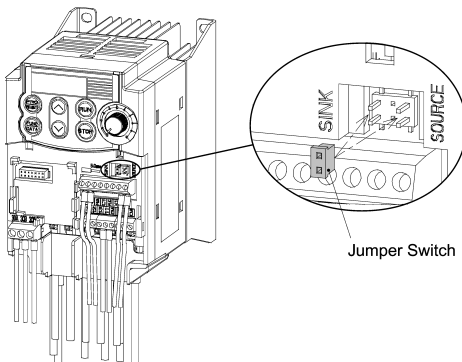

Figure 2.19 Switching of SINK/SOURCE (Jumper Switch)

To switch the sink/source of the digital input signal, change the position of the jumper switch using a pair of long-nose pliers, as shown in Figure 2.19.

At the factory setting, the jumper switch is positioned at SOURCE for the EU version except three-phase 200 V model and at SINK for the Asian and Japanese versions.

2.3.9 Installing an RS-485 communications card (option)

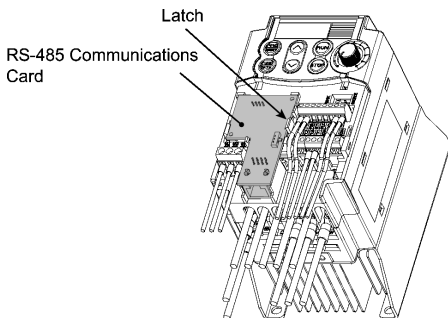

Figure 2.20 Installing an RS-485 Communications Card (Option)

When an optional RS-485 Communications Card is to be used, install it before putting back the control circuit TB cover. Align the card with the latch on the inverter and attach the card to the connector that is located above terminals [30A], [30B] and [30C].

WARNING

- Before installing an RS-485 Communications Card, turn off the power, wait more than five minutes, and make sure, using a circuit tester or a similar instrument, that the DC link bus voltage between the terminals P (+) and N (-) has dropped below a safe voltage (+25 VDC).
- Do not remove the terminal cover for the control circuits while power is applied, because a high voltage exists on the RS-485 Communications Card.

Failure to observe these precautions could cause electric shock.

- In general, sheaths and covers of the control signal cables and wires are not specifically designed to withstand a high electric field (i.e., reinforced insulation is not applied). Therefore, if a control signal cable or wire comes into direct contact with a live conductor of the main circuit, the insulation of the sheath or the cover might break down, which would expose the signal wire to a high voltage of the main circuit. Make sure that the control signal cables and wires will not come into contact with live conductors of the main circuit.

Failure to observe these precautions could cause electric shock and/or an accident.

2.3.10 Replacing the control circuit terminal block (TB) cover

Upon completion of the wiring of the control circuits, fit the latches provided on the upper end of the control circuit TB cover into the openings in the front face of the inverter, and then close the TB cover as shown in Figure 2.21.

Note: Take care not to pinch the control signal wires between the TB cover and inverter body.

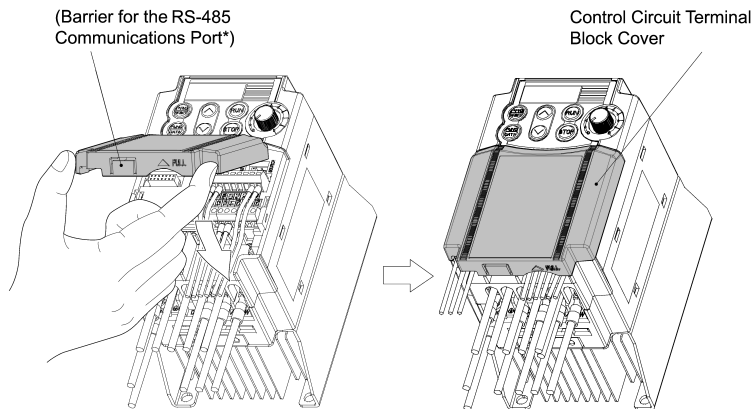

(*When connecting an extension cable for remote operation or an off-the-shelf LAN cable, snip off the barrier of the RS-485 communications cable port using nippers.)

Figure 2.21 Putting Back the Control Circuit Terminal Block (TB) Cover

2.3.11 Cautions relating to harmonic component, noise, and leakage current

(1) Harmonic component

Input current to an inverter includes a harmonic component, which may affect other loads and power factor correcting capacitors that are connected to the same power source as the inverter. If the harmonic component causes any problems, connect a DC reactor (option) to the inverter. It may also be necessary to connect an AC reactor to the power factor correcting capacitors.

(2) Noise

If noise generated from the inverter affects other devices, or that generated from peripheral equipment causes the inverter to malfunction, follow the basic measures outlined below.

- 1) If noise generated from the inverter affects the other devices through power wires or grounding wires:
 - Isolate the grounded metal frames of the inverter from those of the other devices.
 - Connect a noise filter to the inverter power wires.
 - Isolate the power system of the other devices from that of the inverter with an insulated transformer.
- 2) If induction or radio noise generated from the inverter affects other devices through power wires or grounding wires:
 - Isolate the main circuit wires from the control circuit wires and other device wires.
 - Put the main circuit wires through a metal conduit and connect the pipe to the ground near the inverter.
 - Mount the inverter on the metal switchboard and connect the whole board to the ground.
 - Connect a noise filter to the inverter power wires.
- 3) When implementing measures against noise generated from peripheral equipment:
 - For the control signal wires, use twisted or shielded-twisted wires. When using shielded-twisted wires, connect the shield of the shielded wires to the common terminals of the control circuit.
 - Connect a surge absorber in parallel with a coil or solenoid of the magnetic contactor.

(3) Leakage current

Harmonic component current generated by insulated gate bipolar transistors (IGBTs) switching on/off inside the inverter becomes leakage current through stray capacitors of inverter input and output wires or a motor. If any of the problems listed below occur, take appropriate measures against them.

Table 2.9 Leakage Current Countermeasures

Problem	Measures
An earth leakage circuit breaker* that is connected to the input (primary) has tripped. *With overcurrent protection	<ol style="list-style-type: none">1) Decrease the carrier frequency.2) Make the wires between the inverter and motor shorter.3) Use an earth leakage circuit breaker (ELCB) with lower sensitivity than the one currently used.4) Use an earth leakage circuit breaker that features measures against harmonic component (Fuji SG and EG series).
An external thermal relay was activated.	<ol style="list-style-type: none">1) Decrease the carrier frequency.2) Increase the settling current of the thermal relay.3) Use the thermal relay built in the inverter.

Chapter 3 OPERATION USING THE KEYPAD

3.1 Keys, Potentiometer, and LED on the Keypad

As shown in the figure at right, the keypad consists of a four-digit LED monitor, a potentiometer (POT), and six keys.

The keypad allows you to start and stop the motor, monitor running status, and switch to the menu mode. In the menu mode, you may set the function code data, monitor I/O signal states, maintenance information, and alarm information.



Table 3.1 Overview of Keypad Functions

Monitor, Potentiometer and Keys	Functions
	<p>Four-digit, 7-segment LED monitor which displays the following according to the operation modes*.</p> <ul style="list-style-type: none"> ■ In Running mode: Running status information (e.g., output frequency, current, and voltage) ■ In Programming mode: Menus, function codes and their data ■ In Alarm mode: Alarm code, which identifies the error factor if the protective function is activated.
	Potentiometer (POT) which is used to manually set a reference frequency, auxiliary frequencies 1 and 2 or PID process command.
	RUN key. Press this key to run the motor.
	STOP key. Press this key to stop the motor.
	UP/DOWN keys. Press these keys to select the setting items and change the function data displayed on the LED monitor.
	<p>Program/Reset key which switches the operation modes* of the inverter.</p> <ul style="list-style-type: none"> ■ In Running mode: Pressing this key switches the inverter to Programming mode. ■ In Programming mode: Pressing this key switches the inverter to Running mode. ■ In Alarm mode: Pressing this key after removing the error factor will switch the inverter to Running mode.
	<p>Function/Data key which switches the operation you want to do in each mode as follows:</p> <ul style="list-style-type: none"> ■ In Running mode: Pressing this key switches the information to be displayed concerning the status of the inverter (output frequency (Hz), output current (A), output voltage (V), etc.). ■ In Programming mode: Pressing this key displays the function code and sets the data entered with the and keys or the POT. ■ In Alarm mode: Pressing this key displays the details of the problem indicated by the alarm code that has come up on the LED monitor.

* FRENIC-Mini features three operation modes: Running, Programming, and Alarm. Refer to Section 3.2 "Overview of Operation Modes."

Simultaneous keying

Simultaneous keying means pressing two keys at the same time (expressed by "+"). FRENIC-Mini supports simultaneous keying as listed below.

(For example, the expression "⏹ + ⏴ keys" stands for pressing the ⏴ key while holding down the ⏹ key.)

Table 3.2 Simultaneous Keying

Operation mode	Simultaneous keying	Used to:
Running mode	⏹ + ⏴ keys	Control entry to/exit from jogging operation.
Programming mode	⏹ + ⏵ keys	Change certain function code data. (Refer to codes F00, H03, and H97 in Chapter 5 "FUNCTION CODES.")
Alarm mode	⏹ + ⏴Ⓡ keys	Switch to Programming mode without resetting the alarm.

3.2 Overview of Operation Modes

FRENIC-Mini features the following three operation modes:

- Running mode : This mode allows you to enter run/stop commands in regular operation. You can also monitor the running status in real time.
- Programming mode : This mode allows you to set function code data and check a variety of information relating to the inverter status and maintenance.
- Alarm mode : If an alarm condition occurs, the inverter automatically enters the Alarm mode. In this mode, you can view the corresponding alarm code* and its related information on the LED monitor.

* Alarm code: Indicates the cause of the alarm condition that has triggered a protective function. For details, refer to Chapter 8, Section 8.6 "Protective Functions."

Figure 3.1 shows the status transition of the inverter between these three operation modes.

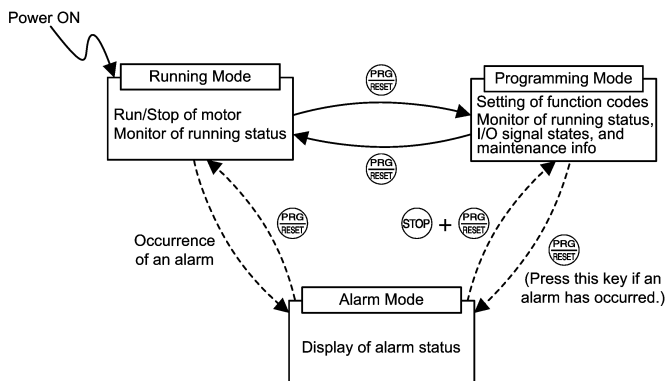
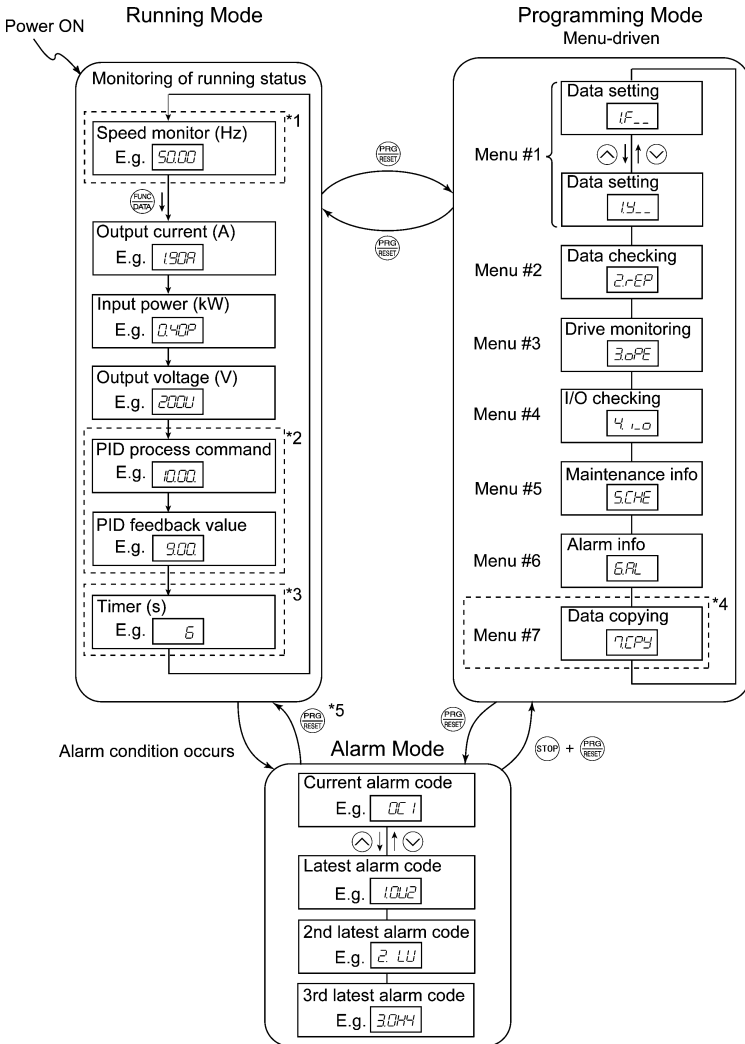

Figure 3.1 Status Transition between Operation Modes

Figure 3.2 illustrates the transition of the LED monitor screen during the Running mode, the transition between menu items in the Programming mode, and the transition between alarm codes at different occurrences in the Alarm mode.



*1 In speed monitor, you can have any of the following displayed according to the setting of function code E48: Output Frequency (Hz), Reference Frequency (Hz), Load Shaft Speed (r/min), Line Speed (m/min), and Constant Rate of Feeding Time (min)

*2 Applicable only when PID control is employed.

*3 Applicable only when timer operation is selected by the setting of function code C21.

*4 Applicable only when a remote keypad (optional) is installed.

*5 Alarm can be reset with the PRG/RESET key only when the current alarm code is displayed.

Figure 3.2 Transition between Basic Display Figures by Operation Mode

3.2.1 Running mode

When the inverter is turned on, it automatically enters Running mode. In Running mode, you can:

- (1) Monitor the running status (e.g., output frequency, output current);
- (2) Set up the reference frequency and others;
- (3) Run/stop the motor; and
- (4) Jog (inch) the motor.

[1] Monitoring the running status

In Running mode, the seven items listed below can be monitored. Immediately after the inverter is turned on, the monitor item specified by function code E43 is displayed. Press the  key to switch between monitor items.

Table 3.3 Monitor Items

Monitor Items	Display Sample on the LED monitor	Meaning of Displayed Value	Function Code E43
Speed monitor (Hz, r/min, m/min, min)	50.00	Refer to Table 3.4.	0
Output current (A)	1.50A	Detected output current. A: alternative expression for A (ampere)	3
Output voltage (V)	200V	Specified output voltage. V: alternative expression for V (voltage)	4
Input power (kW)	0.40P	Electric power input to the inverter. P: alternative expression for kW (kilo watt)	9
PID process command (Note 1)	10.00. (Note 2)	(PID process command or PID feedback amount) × (PID display coefficient A – B) + B	10
PID feedback amount (Note 1)	9.00. (Note 3)	PID display coefficients A and B: Refer to function codes E40 and E41	12
Timer (s) (Note 1)	5 (Note 4)	Remaining effective timer count	13

(Note 1) The PID process command and PID feedback amount are displayed only under the PID control using a process command (J01 = 1 or 2). Further, the timer (for timer operation) is only displayed when the timer is enabled (C21 = 1).

"- - - -" will be displayed when the respective mode (PID control, timer) is not in effect.

(Note 2) The dot in the lowest digit will blink.

(Note 3) The dot in the lowest digit will light.

(Note 4) A positive integer is displayed.

Figure 3.3 shows the procedure for selecting the desired monitor item and the sub-item for speed monitoring.

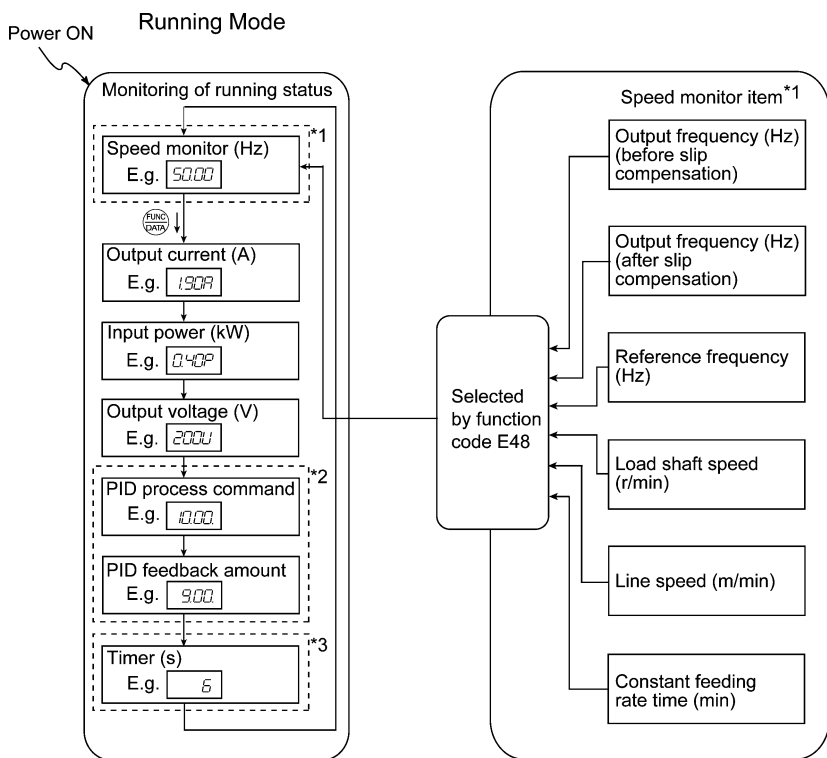

*1 The speed monitor displays the output frequency (Hz), reference frequency (Hz), load shaft speed (r/min), line speed (m/min.), or constant rate of feeding time (min.), depending on the setting of function code E48.

*2 The PID-related information will appear only when the inverter is under PID control. When PID control is not in effect (J01 = 0) while data of the function code E43 is 10 or 12, or immediately after power on, "--" will be displayed.

*3 This will appear only when timer operation is enabled by function code C21. When timer operation is not in effect (C21 = 0) while data of the function code E43 is 13, or immediately after power on, "----" will be displayed.

Figure 3.3 Selecting Monitor Item and Speed Monitor Sub-item

Table 3.4 lists the display items for the speed monitor that can be chosen with function code E48.

Table 3.4 Display Items on the Speed Monitor

Speed monitor items	Function code E48	Meaning of Displayed Value
Output frequency (before slip compensation) (Hz) (Factory default)	0	Before slip compensation
Output frequency (after slip compensation) (Hz)	1	Frequency actually being output
Reference frequency (Hz)	2	Final reference frequency
Load shaft speed (r/min)	4	Displayed value = Output frequency (Hz) x E50*
Line speed (m/min)	5	Displayed value = Output frequency (Hz) x E50*
Constant rate of feeding time (min)	6	Displayed value = $\frac{E50}{\text{Output frequency} \times E39}$ *

* When the value is equal to or more than 10000, [] will be displayed. Output frequencies contained in these formulas are output frequencies before slip compensation.

[2] Setting up reference frequency, etc.







You can set up the desired frequency command and PID process command by using the potentiometer and Δ and ∇ keys on the keypad. You can also set up the reference frequency as load shaft speed, line speed, and constant rate of feeding time by setting function code E48.















■ Setting up a reference frequency

Using the built-in potentiometer (factory default)

By setting function code F01 to "4: Built-in potentiometer (POT)" (factory default), you can specify the reference frequency using the potentiometer.

Using the and keys

- (1) Set function code F01 to "0:  /  keys on the built-in keypad." This can be done only when the remote keypad is in Running mode.
- (2) Press the  or  key to specify the reference frequency. The lowest digit will blink.
- (3) If you need to change the reference frequency, press the  or  key again. The new setting will be automatically saved into the inverter's memory. It is kept there even while the inverter is powered off, and will be used as the initial frequency next time the inverter is powered on.

-  **Tip** • If you have set the function code F01 to "0:  /  keys on the built-in keypad" but have selected a frequency setting other than the frequency 1 (i.e., the frequency 2, set it via communications, or as a multi-frequency), then you cannot use the  or  key for setting the reference frequency even if the remote keypad is in Running mode. Pressing either of these keys will just display the currently selected reference frequency.
- When you start specifying or changing the reference frequency or any other parameter with the  or  key, the lowest digit on the display will blink and start changing. As you are holding the key down, blinking will gradually move to the upper digit places and the upper digits will be changeable.
 - If you press the  or  key once and then hold down the  key for more than 1 second after the lowest digit starts blinking, blinking will move to the next upper digit place to allow you to change the value of that digit (cursor movement). This way you can easily change the values of the higher digits.
 - By setting function code C30 to "0:  /  keys on the built-in keypad" and selecting frequency set 2 as the frequency setting method, you can also specify or change the reference frequency in the same manner using the  and  keys.

Alternatively, you can set up the reference frequency, etc. from other menu items, depending on the setting of function code E48 (= 4, 5, or 6) "LED monitor (Speed monitor item)" as shown in the following table.

Table 3.5 LED Monitor and Frequency Setting (with Speed Monitor selected)

Setting of E48 (displayed on LED monitor) (with Speed Monitor selected)	Reference frequency display	Conversion of displayed value
0: Output frequency (before slip compensation)	Frequency setting	
1: Output frequency (after slip compensation)	Frequency setting	
2: Reference frequency	Frequency setting	
4: Load shaft speed	Load shaft speed setting	Frequency setting × E50
5: Line speed	Line speed setting	Frequency setting × E50
6: Constant rate of feeding time	Constant rate of feeding time setting	$\frac{E50}{\text{Frequency setting} \times E39}$

■ Make setting under PID control

To enable PID control, you need to set function code J01 to 1 or 2.

Under the PID control, the items that can be set or checked with the \triangle and ∇ keys are different from those under regular frequency control, depending upon the current LED monitor setting. If the LED monitor is set to the speed monitor (E43 = 0), you may access manual feed commands (Reference frequency) with the \triangle and ∇ keys; if it is set to any other, you may access PID process command with those keys.

 Refer to the FRENIC-Mini User's Manual (MEH446), Chapter 4, Section 4.8 "PID Frequency Command Generator" for details on the PID control.

Setting the PID process command with the built-in potentiometer

- (1) Set function code E60 to "3: PID process command 1."
- (2) Set function code J02 to "1: PID process command 1."

Setting the PID process command with the \triangle and ∇ keys

- (1) Set function code J02 to "0: \triangle / ∇ keys on the built-in keypad."
- (2) Set the LED monitor to something other than the speed monitor (E43 = 0) in Running mode. This setting is possible only in Running mode.
- (3) Press the \triangle or ∇ key to display the PID process command. The lowest digit of the displayed command and the decimal point blink.
- (4) To change the PID process command, press the \triangle or ∇ key again. The PID process command you have specified will be automatically saved into the inverter's memory. It is kept there even if you temporarily switch to another means of specifying the PID process command and then go back to the means of specifying the PID process command via the remote keypad. Also, it is kept there even while the inverter is powered off, and will be used as the initial PID process command next time the inverter is powered on.

-  **Tip**
- Even if multi-frequency is selected as the PID process command (**SS4** = ON), you still can set the process command using the remote keypad.
 - When function code J02 data has been set to any value except 0, pressing the \triangle or ∇ key displays the PID process command currently selected (you cannot change the setting).
 - When a PID process command is displayed, the decimal point next to the lowest digit on the LED display blinks to distinguish it from the regular frequency setting. When a PID feedback amount is displayed, the decimal point next to the lowest digit on the LED display is lit.



Setting up the reference frequency with the \wedge and \vee keys under PID control

To set the reference frequency with the \wedge and \vee keys under the PID control, you need to specify the following conditions:

- Set function code F01 to "0: \wedge / \vee keys on the built-in keypad."
- Select frequency command 1 (Frequency settings from communications link: Disabled, and Multi-frequency settings: Disabled) as manual speed command.
- Set the LED monitor to the speed monitor in Running mode.

The above setting is impossible in any operation mode except Running mode.

The setting procedure is the same as that for usual frequency setting.

If you press the \wedge or \vee key in any conditions other than those described above, the following will appear:

Table 3.6 Manual Speed (Frequency) Command Specified with \wedge / \vee Keys and Requirements

Frequency command 1 (F01)	Frequency setting via communications link	Multi-frequency setting	PID control cancelled	Display during \wedge or \vee key operation
0	Disabled	Disabled	PID enabled	PID output (as final frequency command)
			Cancelled	Manual speed (frequency) command set by keypad
Other than the above			PID enabled	PID output (as final frequency command)
			Cancelled	Manual speed (frequency) command currently selected

[3] Running/stopping the motor

By factory default, pressing the RUN key starts running the motor in the forward direction and pressing the STOP key decelerates the motor to stop. The RUN key is enabled only in Running mode.

By changing the setting of function code F02, you can change the starting direction of motor rotation; for example, you can have the motor start running in the reverse direction or in accordance with the wiring connection at the terminal block.



■ Operational relationship between function code F02 (Operation method) and key



Table 3.7 lists the relationship between function code F02 settings and the  key, which determines the motor rotational direction.

Table 3.7 Rotational Direction of Motor, Specified by F02

If Function code F02 is set to:	Pressing the  key rotates the motor:
2	in the forward direction
3	in the reverse direction



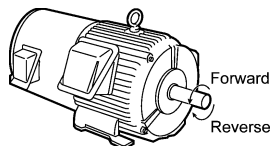

(Note) The rotational direction of IEC-compliant motors is opposite to one shown here.

For the details of operation with function code F02 set to "0" or "1," refer to Chapter 5.



[4] Jogging (inching) the motor

To jog the motor, follow the procedure given below.



① Making the inverter ready for jogging (The  appears on the LED monitor.)

- 1) Switch to Running mode. (Refer to page 3-2 for details.)
- 2) Press the  +  keys at the same time (simultaneous keying).



The LED monitor will display the jogging frequency for approx. 1 second and go back to the  display.

-  Tip
- During jogging, the jogging frequency specified by function code C20 and the acceleration/deceleration time specified by function code H54 for jogging will apply. They are exclusively prepared for jogging. Set these codes individually as required.
 - Using the external input signal **JOG** also allows the transition between the ready-to-jog state and normal running state.
 - The transition ( +  keys) between the ready-to-jog state and normal running state is enabled only when the inverter is not in operation.

② Jogging the motor

- 1) The inverter will jog the motor only while the  key is held down, and contrarily the moment the  key is released, the inverter will decelerate and stop the motor.

③ Exiting the ready-to-jog state (Going back to normal running)

- 1) Press the  +  keys at the same time (simultaneous keying).

3.2.2 Programming mode

Programming mode provides you with these functions--setting and checking function code data, monitoring maintenance information and checking input/output (I/O) signal status. The functions can be easily selected with the menu-driven system. Table 3.8 lists menus available in Programming mode. The leftmost digit (numerals) of each letter string indicates the corresponding menu number and the remaining three digits indicate the menu contents.

When the inverter enters Programming mode from the second time on, the menu that was selected last in Programming mode will be displayed.

Table 3.8 Menus Available in Programming Mode

Menu #	Menu	LED monitor shows:	Main functions	Refer to:	
#1	"Data setting"	<i>F--</i>	F codes (Fundamental functions)	Selecting each of these function codes enables its data to be displayed/changed.	[1]
		<i>E--</i>	E codes (Extension terminal functions)		
		<i>C--</i>	C codes (Control functions of frequency)		
		<i>P--</i>	P codes (Motor parameters)		
		<i>H--</i>	H codes (High performance functions)		
		<i>J--</i>	J codes (Application functions)		
		<i>Y--</i>	y codes (Link functions)		
#2	"Data checking"	<i>2-FP</i>	Displays only function codes that have been changed from their factory defaults. You may refer to or change those function codes data.	[2]	
#3	"Drive monitoring"	<i>3-DF</i>	Displays the running information required for maintenance or test running.	[3]	
#4	"I/O checking"	<i>4-IO</i>	Displays external interface information.	[4]	
#5	"Maintenance information"	<i>5-CH</i>	Displays maintenance information including accumulated run time.	[5]	
#6	"Alarm information"	<i>6-AL</i>	Displays the latest four alarm codes. You may refer to the running information at the time when the alarm occurred.	[6]	
#7	"Data copying" *	<i>7-CPY</i>	Allows you to read or write function code data, as well as verifying it.	--	

*To use this function, a remote keypad (option) is required.

Figure 3.4 illustrates the menu transition in Programming mode.

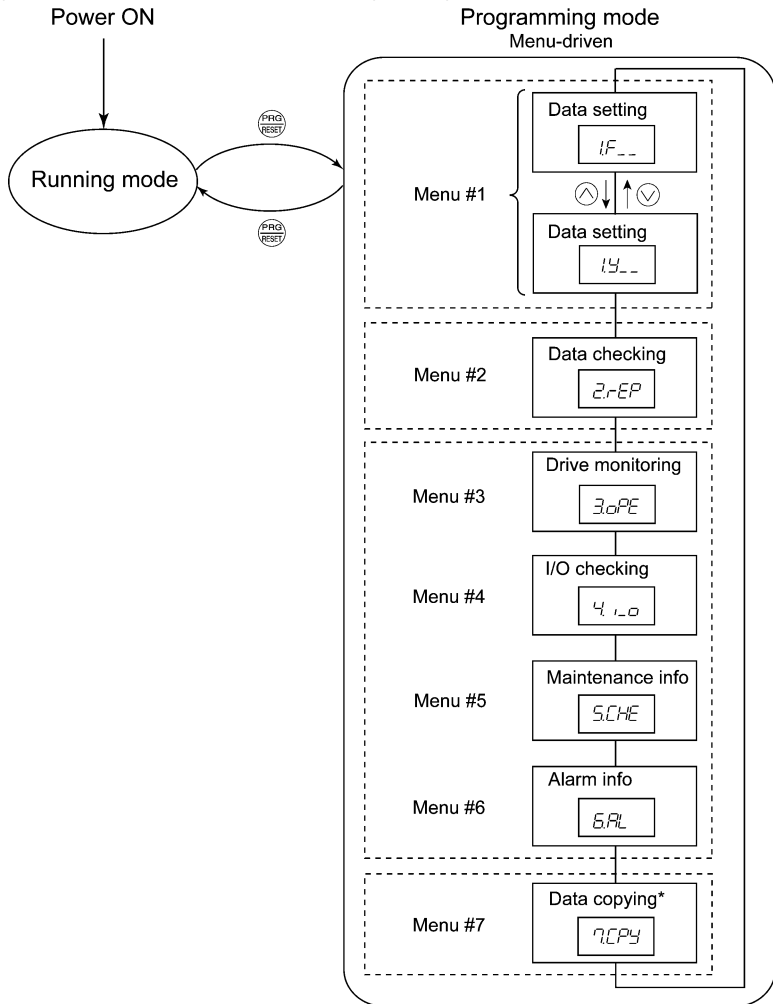

* Displayed only when a remote keypad (option) is set up for use.

Figure 3.4 Menu Transition in Programming Mode

Limiting menus to be displayed



The menu-driven system has a limiter function (specified by function code E52) that limits menus to be displayed for the purpose of simple operation. The factory default is to display Menu #1 "Data setting" only, allowing no switching to any other menu.

Table 3.9 Function Code E52 – Keypad (Mode Selection)

Function code data (E52)	Menus selectable
0: Function code data editing mode	Menu #1 "Data setting" (factory default)
1: Function code data check mode	Menu #2 "Data checking"
2: Full-menu mode	Menu #1 through #6 (#7*)

* Menu #7 appears only when the remote keypad (option) is set up for use.



Tip If the full-menu mode is selected, pressing the  or  key will cycle through the menu. With the  key, you can select the desired menu item. Once the entire menu has been cycled through, the display will return to the first menu item.

[1] Setting function codes – "Data Setting"

Menu #1 "Data setting" in Programming mode allows you to set function codes for making the inverter functions match your needs.

To set function codes in Menu #1 "Data setting," it is necessary to set function code E52 data to "0" (Function code data editing mode) or "2" (Full-menu mode).

The table below lists the function codes available in the FRENIC-Mini. The function codes are displayed on the LED monitor on the keypad as shown below.

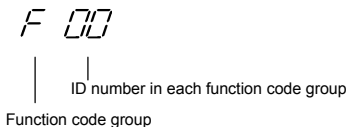





Table 3.10 List of FRENIC-Mini Function Codes

Function code group	Function code	Function	Description
F codes	F00 to F51	Fundamental functions	To be used for basic motor running.
E codes	E01 to E99	Extension terminal functions	To be used to select the functions of the control circuit terminals. To be used to set functions related to the LED monitor display.
C codes	C01 to C52	Control functions of frequency	To be used to set application functions related to frequency settings.
P codes	P02 to P99	Motor parameters	To be used to set special parameters for the motor capacity, etc.
H codes	H03 to H98	High performance functions	To be used for high added value functions and complicated control, etc.
J codes	J01 to J06	Application functions	To be used for PID control.
y codes	y01 to y99	Link functions	To be used for communications

 Refer to Chapter 5 "FUNCTION CODES" for details on the function codes.

Function codes that require simultaneous keying

To change data for function codes F00 (Data protection), H03 (Data initialization), and H97 (Clear alarm data) simultaneous keying operation is necessary-- +  keys or  +  keys. This prevents data from being lost by mistake.

Changing, validating, and saving function code data when the motor is running

Some function code data can be changed while the motor is running and some cannot. Further, amongst the function codes whose data can be changed while the motor is running, there are some for which the changes can be validated immediately and others for which they cannot. Refer to the "Change when running" column in Chapter 5, Section 5.1 "Function Code Tables."

Figure 3.5 shows the status transition for Menu #1 "Data setting."

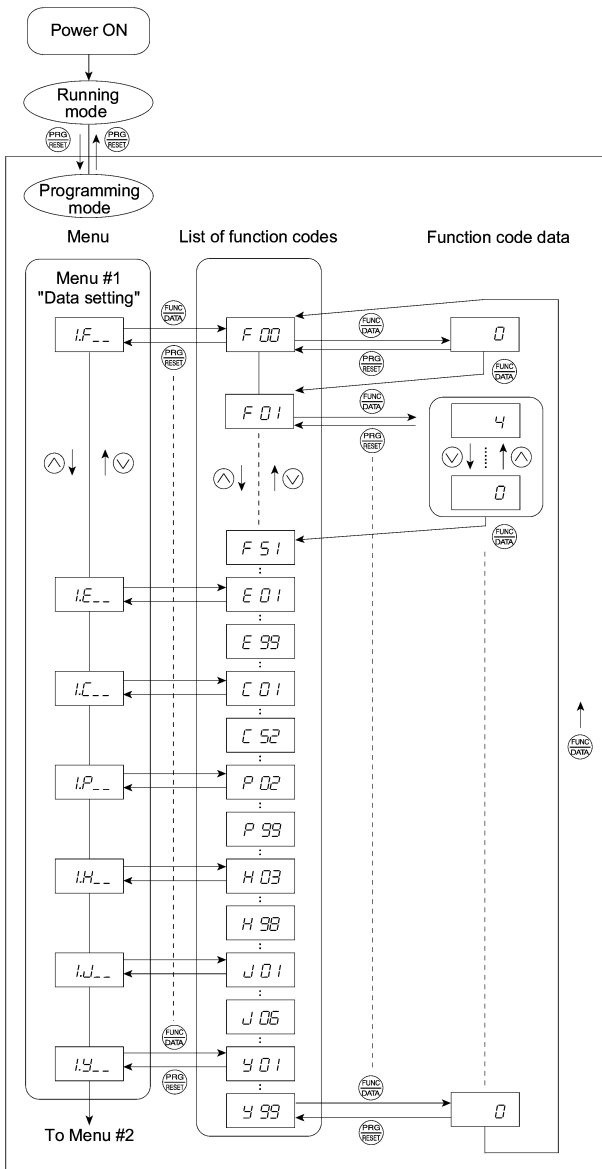



















Figure 3.5 "Data Setting" Status Transition

Basic key operation

This section will give a description of the basic key operation, following the example of the function code data changing procedure shown in Figure 3.6.

This example shows you how to change function code F01 data from the factory default "Built-in potentiometer (POT) (F01 = 4)" to "△/▽ keys on the built-in keypad (F01 = 0)."

- (1) When the inverter is powered on, it automatically enters Running mode. In Running mode, press the  key to enter Programming mode. The menu for function selection will be displayed.
- (2) With the menu displayed, use the  and  keys to select the desired function code group. (In this example, select *F_*).
- (3) Press the  key to display the function codes in the function code group selected in (2). (In this example, function code *F 01* will appear.)
Even if the function code list for a particular function code group is displayed, it is possible to transfer the display to a different function code group using the  and  keys.
- (4) Select the desired function code using the  and  keys and press the  key. (In this example, select function code *F 01*.)
The data of this function code will appear. (In this example, data "4" of *F 01* will appear.)
- (5) Change the function code data using the  and  keys. (In this example, press the  key four times to change data 4 to 0.)
- (6) Press the  key to establish the function code data.
The *SAVE* will appear and the data will be saved in the memory inside the inverter. The display will return to the function code list, then move to the next function code. (In this example, *F 02*.)
Pressing the  key before the  key cancels the change made to the data. The data reverts to the previous value, the display returns to the function code list, and the original function code reappears.
- (7) Press the  key to return to the menu from the function code list.

 **Tip** <Cursor movement>

You can move the cursor when changing function code data by holding down the  key for 1 second or longer in the same way as with the frequency settings.

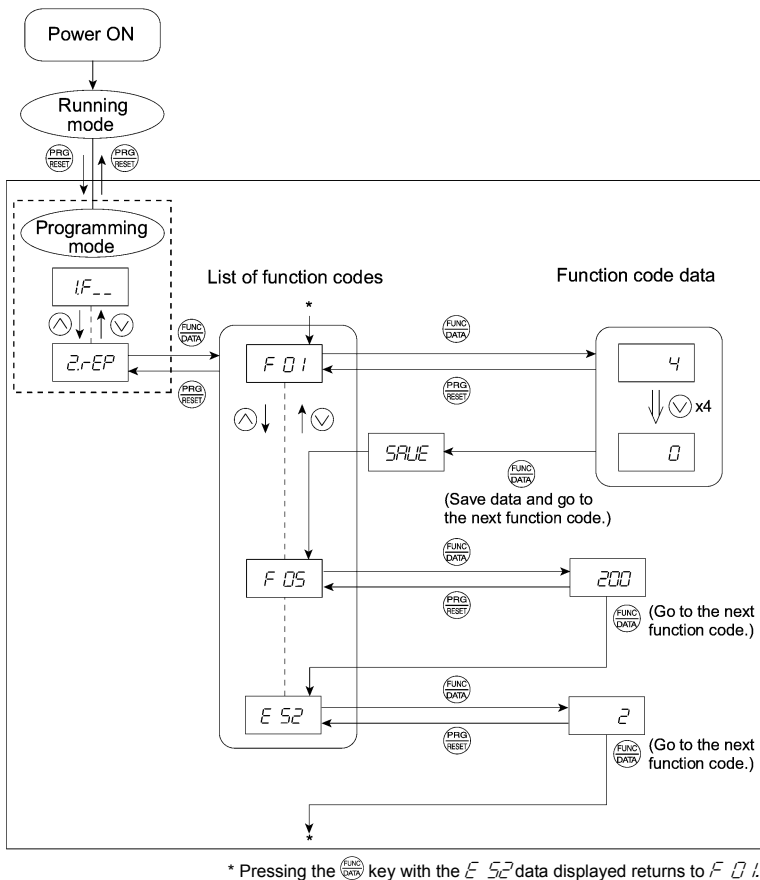

Figure 3.7 "Data Checking" Status Transition (Changes made only to F01, F05, E52)

Basic key operation

The basic key operation is the same as for "Data setting."

Tip To check function codes in Menu #2 "Data checking," it is necessary to set function code E52 to "1" (Function code data check mode) or "2" (Full-menu mode).

For details, refer to "Limiting menus to be displayed" on page 3-13.

[3] Monitoring the running status – "Drive Monitoring"

Menu #3 "Drive monitoring" is used to check the running status during maintenance and test running. The display items for "Drive monitoring" are listed in Table 3.11. Figure 3.8 shows the status transition diagram for "Drive monitoring."

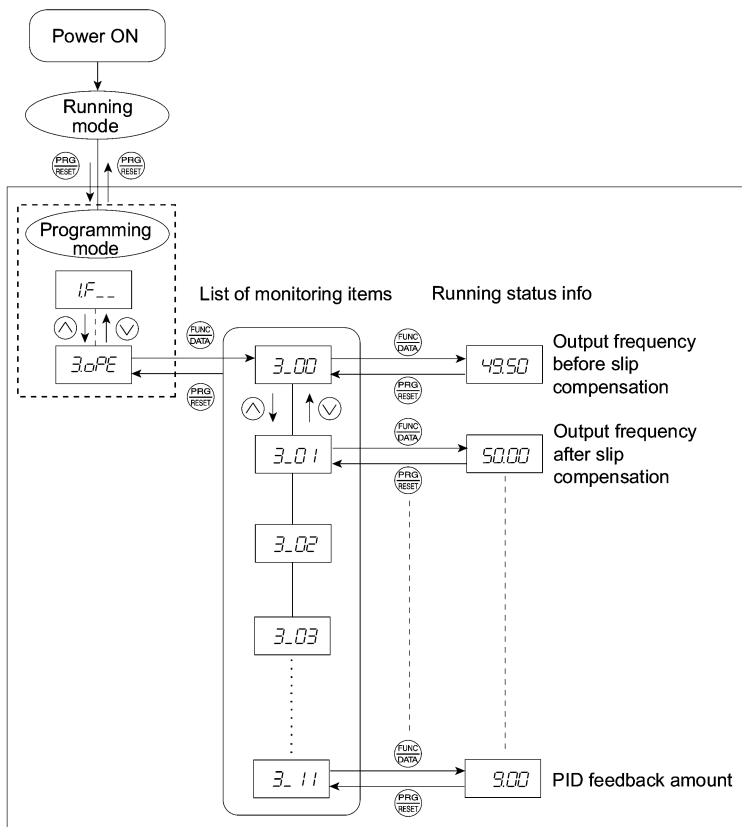

Figure 3.8 "Drive Monitoring" Status Transition

Basic key operation

Before checking the running status on the drive monitor, set function code E52 to "2" (full-menu mode).









- When the inverter is powered on, it automatically enters Running mode. In Running mode, press the  key to enter Programming mode. The menu for function selection will be displayed.
- With the menu displayed, use the  and  keys to select "Drive monitoring" (*3.0PE*).
- Press the  key to display the desired code in the monitoring item list (e.g. *3.00*).
- Use the  and  keys to select the desired monitoring item, then press the  key.
The running status information for the selected item will appear.
- Press the  key to return to the monitoring item list. Press the  key again to return to the menu.

Table 3.11 Drive Monitoring Display Items

LED monitor shows:	Contents	Unit	Description
<i>3.00</i>	Output frequency	Hz	Output frequency before slip compensation
<i>3.01</i>	Output frequency	Hz	Output frequency after slip compensation
<i>3.02</i>	Output current	A	Output current
<i>3.03</i>	Output voltage	V	Output voltage
<i>3.05</i>	Reference frequency	Hz	Reference frequency
<i>3.06</i>	Running direction	N/A	Displays the running direction currently being outputted. F: forward; R: reverse, ----: stop
<i>3.07</i>	Running status	N/A	Displays the running status in hex. format. Refer to " Displaying running status " on the next page.
<i>3.09</i>	Load shaft speed (line speed)	r/min (m/min)	The unit for load shaft speed is r/min and that for line speed is m/min. Display value = (Output frequency Hz before slip compensation) × (Function code E50) [] appears for 10000 (r/min or m/min) or more. When [] appears, decrease function code E52 data so that the LED monitor displays 9999 or below, referring to the above equation.
<i>3.10</i>	PID process command	N/A	The command is displayed through the use of function code E40 and E41 data (PID display coefficients A and B). Display value = (PID process command) × (Coefficient A - B) + B If PID control is disabled, "----" appears.
<i>3.11</i>	PID feedback amount	N/A	This value is displayed through the use of function code E40 data and function code E41 data (PID display coefficients A and B). Display value = (PID feedback amount) × (Coefficient A - B) + B If PID control is disabled, "----" appears.

Displaying running status

To display the running status in hexadecimal format, each state has been assigned to bits 0 to 15 as listed in Table 3.12. Table 3.13 shows the relationship between each of the status assignments and the LED monitor display. Table 3.14 gives the conversion table from 4-bit binary to hexadecimal.

Table 3.12 Running Status Bit Allocation

Bit	Notation	Content	Bit	Notation	Content
15	BUSY	1 when function code data is being written.	7	VL	1 under voltage limiting control.
14	WR	Always 0.	6	TL	Always 0.
13		Always 0.	5	NUV	1 when the DC link bus voltage is higher than the undervoltage level.
12	RL	1 when communication is enabled (when ready for run and frequency commands via communications link).	4	BRK	Always 0.
11	ALM	1 when an alarm has occurred.	3	INT	1 when the inverter output is stopped.
10	DEC	1 during deceleration.	2	EXT	1 during DC braking.
9	ACC	1 during acceleration.	1	REV	1 during running in the reverse direction.
8	IL	1 under current limiting control.	0	FWD	1 during running in the forward direction.

Table 3.13 Running Status Display

LED No.		LED4				LED3				LED2				LED1												
Bit		15	14	13	12	11	10	9	8	7	6	5	4	3	2	1	0									
Notation		BUSY	WR	RL	ALM	DEC	ACC	IL	VL	TL	NUV	BRK	INT	EXT	REV	FWD										
Example	Binary	1	0	0	0	0	0	1	1	0	0	1	0	0	0	0	1									
	Hexa-decimal on the LED monitor	<table style="margin-left: auto; margin-right: auto; border-collapse: collapse;"> <tr> <td style="border: none;"></td> <td style="border: none; text-align: center;">LED4</td> <td style="border: none; text-align: center;">LED3</td> <td style="border: none; text-align: center;">LED2</td> <td style="border: none; text-align: center;">LED1</td> </tr> <tr> <td style="border: none;"></td> <td style="border: 1px solid black; padding: 5px; text-align: center;">8</td> <td style="border: 1px solid black; padding: 5px; text-align: center;">3</td> <td style="border: 1px solid black; padding: 5px; text-align: center;">2</td> <td style="border: 1px solid black; padding: 5px; text-align: center;">1</td> </tr> </table>																	LED4	LED3	LED2	LED1		8	3	2
	LED4	LED3	LED2	LED1																						
	8	3	2	1																						

Hexadecimal expression

A 4-bit binary number can be expressed in hexadecimal format (1 hexadecimal digit). Table 3.14 shows the correspondence between the two notations. The hexadecimals are shown as they appear on the LED monitor.

Table 3.14 Binary and Hexadecimal Conversion

Binary				Hexadecimal	Binary				Hexadecimal
0	0	0	0	0	1	0	0	0	8
0	0	0	1	1	1	0	0	1	9
0	0	1	0	2	1	0	1	0	A
0	0	1	1	3	1	0	1	1	B
0	1	0	0	4	1	1	0	0	C
0	1	0	1	5	1	1	0	1	D
0	1	1	0	6	1	1	1	0	E
0	1	1	1	7	1	1	1	1	F

[4] Checking I/O signal status – "I/O Checking"

With Menu #4 "I/O checking," you can display the I/O status of external signals without using a measuring instrument. External signals that can be displayed include digital I/O signals and analog I/O signals. Table 3.15 lists check items available. The status transition for I/O checking is shown in Figure 3.9.

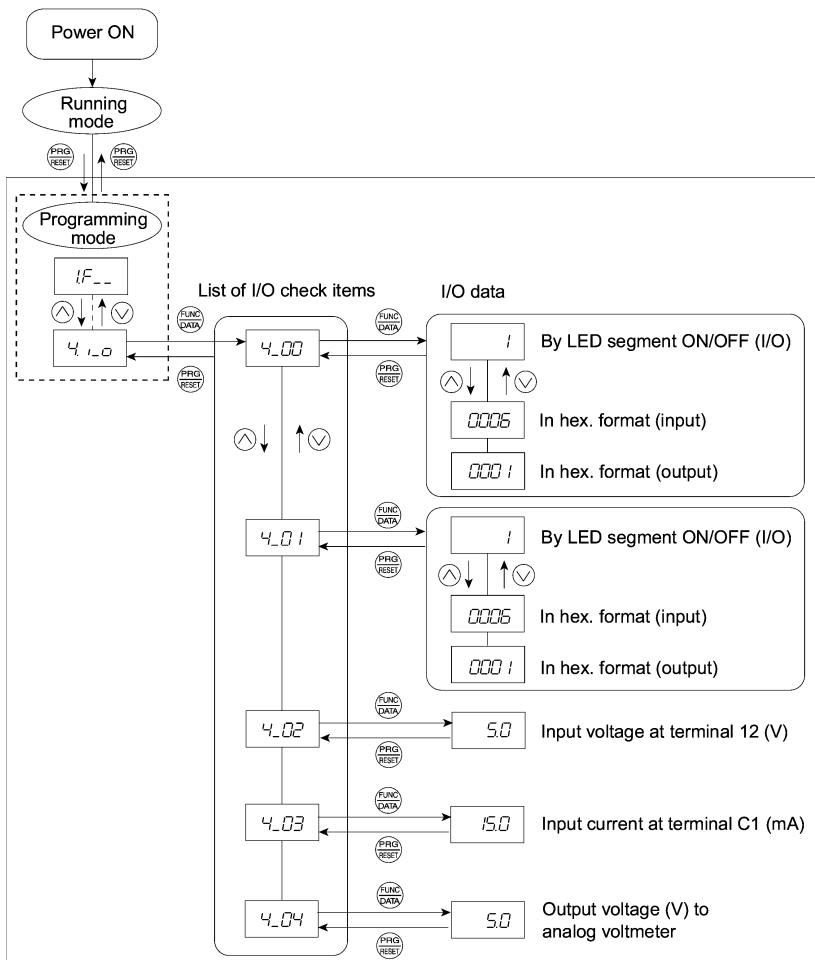

Figure 3.9 "I/O Checking" Status Transition

Basic key operation

Before checking the status of the I/O signals, set function code E52 to "2: Full-menu mode."











- (1) When the inverter is powered on, it automatically enters Running mode. In Running mode, press the  key to enter Programming mode. The menu for function selection will be displayed.
- (2) With the menu displayed, use the  and  keys to select "I/O check" (4. I_O).
- (3) Press the  key to display the codes for the I/O check item list. (e.g. 4.00)
- (4) Use the  and  keys to select the desired I/O check item, then press the  key. The corresponding I/O check data will appear. For control I/O signal terminal and control circuit terminal input under communication control, use the  and  keys to select one of the two different display methods.
- (5) Press the  key to return to the I/O check item list. Press the  key again to return to the menu.

Table 3.15 I/O Check Items

LED monitor shows:	Contents	Description
4.00	I/O signals on the control circuit terminals	Shows the ON/OFF state of the digital I/O terminals. Refer to " Displaying control I/O signal terminals " below for details on the display contents.
4.01	I/O signals on the control circuit terminals under communication control	Shows the ON/OFF state for the digital I/O terminals that received a command via RS-485 communications. Refer to " Displaying control I/O signal terminals " and " Displaying control I/O signal terminals under communication control " below for details of the item displayed.
4.02	Input voltage on terminal [12]	Shows the input voltage on terminal [12] in volts (V).
4.03	Input current on terminal [C1]	Shows the input current on terminal [C1] in milliamperes (mA).
4.04	Output voltage to analog meters [FMA]	Shows the output voltage on terminal [FMA] in volts (V).

Displaying control I/O signal terminals

The status of control I/O signal terminal status may be displayed with ON/OFF of the LED segment or in hexadecimal display.

■ Display I/O signal status with ON/OFF of the LED Segment

As shown in Table 3.16 and the figure below, each of the segments "a" to "e" on LED1 lights when the corresponding digital input terminal ([FWD], [REV], [X1], [X2], or [X3]) is short-circuited with terminal [CM] or [PLC]*, and does not light when it is open. Segment "a" on LED3 lights when the circuit between output terminals [Y1] and [Y1E] is closed and does not light when the circuit is open. Segment "a" on LED4 is for terminal [30ABC]. Segment "a" on LED4 lights when the circuit between terminals [30C] and [30A] is short-circuited (ON) and does not light when it is open.

*Terminal [CM] if the jumper switch is set for SINK; terminal [PLC] if the jumper switch is set for SOURCE.



- If all terminal input signals are OFF (open), segment "g" on all of LEDs 1 to 4 will light ("— — — —").
- Refer to Chapter 5 "FUNCTION CODES" for details.

Table 3.16 Segment Display for External Signal Information

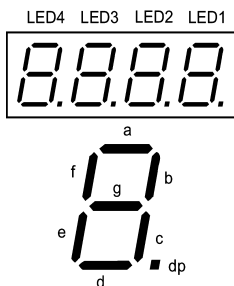

Segment	LED4	LED3	LED2	LED1
a	30ABC	Y1-Y1E	—	FWD-CM or FWD-PLC *2
b	—	—	—	REV-CM or REV-PLC *2
c	—	—	—	X1-CM or X1-PLC *2
d	—	—	—	X2-CM or X2-PLC *2
e	—	—	—	X3-CM or X3-PLC *2
f	—	—	(XF) *1	—
g	—	—	(XR) *1	—
dp	—	—	(RST) *1	—

—: No corresponding control circuit terminal exists.

*1 (XF), (XR), and (RST) are assigned for communication. Refer to "**Displaying control I/O signal terminals under communication control**" on the next page.

*2 Terminal [CM] if the jumper switch is set for a sink; terminal [PLC] if the jumper switch is set for a source.

■ Displaying I/O signal status in hexadecimal format

Each I/O terminal is assigned to bit 15 through bit 0 as shown in Table 3.17. An unassigned bit is interpreted as "0." Allocated bit data is displayed on the LED monitor in 4 hexadecimal digits ("0" to "F" each).

With the FRENIC-Mini, digital input terminals [FWD] and [REV] are assigned to bit 0 and bit 1, respectively. Terminals [X1] through [X3] are assigned to bits 2 through 4. The bit is set to "1" when the corresponding input terminal is short-circuited with terminal [CM] or terminal [PLC] *, and is set to "0" when it is open. For example, when [FWD] and [X1] are on (short-circuited) and all the others are off (open), "0005" is displayed on LED4 to LED1.

* Terminal [CM] if the jumper switch is set for a sink; terminal [PLC] if the jumper switch is set for a source.

Digital output terminal [Y1] is assigned to bit 0. Bit 0 is set to "1" when this terminal is short-circuited with [Y1E], and to "0" when it is open. The status of the relay contact output terminal [30ABC] is assigned to bit 8. It is set to "1" when the circuit between output terminals [30A] and [30C] is closed and to "0" when the circuit between [30B] and [30C] is closed. For example, if [Y1] is on and [30A] is connected to [30C], then "0101" is displayed on the LED4 to LED1.

Table 3.17 presents an example of bit assignment and corresponding hexadecimal display on the 7-segment LED.

Table 3.17 Segment Display for I/O Signal Status in Hexadecimal Format

LED No.	LED4				LED3				LED2				LED1				
Bit	15	14	13	12	11	10	9	8	7	6	5	4	3	2	1	0	
Input terminal	(RST)*	(XR)*	(XF)*	-	-	-	-	-	-	-	-	X3	X2	X1	REV	FWD	
Output terminal	-	-	-	-	-	-	-	30AC	-	-	-	-	-	-	-	Y1	
Example	Binary	0	0	0	0	0	0	0	0	0	0	0	0	0	1	0	1
	Hexa-decimal on the LED monitor	 LED4 LED3 LED2 LED1															

- : No corresponding control terminal exists.

* (XF), (XR), and (RST) are assigned for communication. Refer to "**Displaying control I/O signal terminals under communication control.**"

Displaying control I/O signal terminals under communication control

During control via communication, input commands sent via RS-485 communications cable can be displayed in two ways: "display with ON/OFF of the LED segment" and "in hexadecimal format." The content to be displayed is basically the same as that for the control I/O signal terminal status display; however, (XF), (XR), and (RST) are added as inputs. Note that under communications control, I/O display is in normal logic (using the original signals that are not inverted).

 Refer to RS-485 Communication User's Manual (MEH448) for details on input commands sent through RS-485 communications.

[5] Reading maintenance information – "Maintenance Information"

Menu #5 "Maintenance information" in Programming mode contains information necessary for performing maintenance on the inverter. Table 3.18 lists the maintenance information display items and Figure 3.10 shows the status transition for maintenance information.

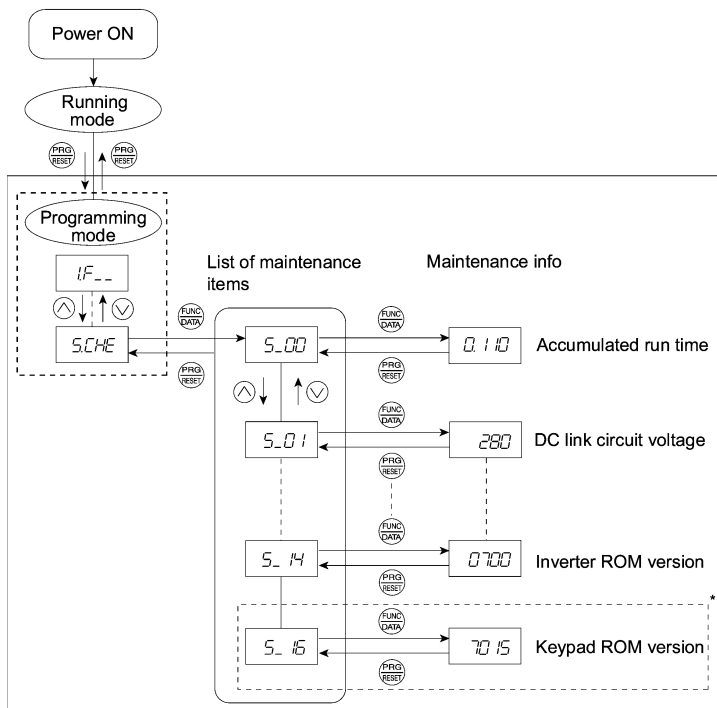

* The part in the dotted-line box is applicable only when a remote keypad is set up for operation.

Figure 3.10 "Maintenance Information" Status Transition

Basic key operation

Before viewing maintenance information, set function code E52 to "2" (full-menu mode).

- (1) When the inverter is powered on, it automatically enters Running mode. In Running mode, press the **PRG/RESET** key to enter Programming mode. The menu for function selection will be displayed.
- (2) With the menu displayed, use the **▲** and **▼** keys to select "Maintenance information" (**S.CHE**).
- (3) Press the **FUNC/DATA** key to display the list of maintenance item codes (e.g. **S_00**).
- (4) Use the **▲** and **▼** keys to select the desired maintenance item, then press the **FUNC/DATA** key. The data of the corresponding maintenance item will appear.
- (5) Press the **PRG/RESET** key to return to the list of maintenance items. Press the **PRG/RESET** key again to return to the menu.

Table 3.18 Maintenance Display Items

LED Monitor shows:	Contents	Description
5_00	Cumulative run time	Shows the cumulative power-ON time of the inverter. Unit: thousands of hours. When the total ON-time is less than 10000 hours (display: 0.001 to 9.999), data is shown in units of one hour. When the total time is 10000 hours or more (display: 10.00 to 65.53), it is shown in units of 10 hours. When the total time exceeds 65535 hours, the display will be reset to 0 and the count will start again.
5_01	DC link bus voltage	Shows the DC link bus voltage of the inverter. Unit: V (volts)
5_03	Max. temperature of heat sink	Shows the maximum temperature of the heat sink for every hour. Unit: °C
5_04	Max. effective current	Shows the maximum effective current for every hour. Unit: A (amperes)
5_05	Capacitance of the DC link bus capacitor	Shows the current capacitance of the DC link bus capacitor, based on the capacitance when shipping as 100%. Refer to Chapter 7 "MAINTENANCE AND INSPECTION" for details. Unit: %
5_06	Cumulative run time of electrolytic capacitors on the printed circuit boards	Shows the cumulative run time of the capacitors mounted on the printed circuit boards. The display method is the same as for "accumulated run time" above. However, when the total time exceeds 65535 hours, the count stops and the display remains at 65.53.
5_07	Cumulative run time of the cooling fan	Shows the cumulative run time of the cooling fan. This counter does not work when the fan stops even if the cooling fan ON/OFF control (function code H06) is enabled. The display method is the same as for "Cumulative run time (5_05)" above. However, when the total time exceeds 65535 hours, the count stops and the display remains at 65.53.
5_08	Number of startups	Shows the cumulative counter of times the inverter is started up (i.e., the number of run commands issued). 1.000 indicates 1000 times. When any number from 0.001 to 9.999 is displayed, the counter increases by 0.001 per startup, and when any number from 10.00 to 65.53 is counted, the counter increases by 0.01 every 10 startups. When the counted number exceeds 65535, the counter will be reset to 0 and the count will start again.
5_11	No. of RS-485 errors	Shows the cumulative total number of RS-485 communication errors since first power ON. Once the number of errors exceeds 9999, the display (count) returns to 0.
5_12	RS-485 communications error content	Shows the latest error that has occurred with RS-485 communications in decimal format. For error contents, refer to the RS-485 Communication User's Manual (MEH448).
5_14	ROM version of the inverter	Shows the ROM version of the inverter as a 4-digit display.
5_15	ROM version of the keypad	Shows the ROM version of the keypad panel as a 4-digit display. (For active remote keypad only.)

[6] Reading alarm information – "Alarm Information"

Menu #6 "Alarm information" in Programming mode shows, in alarm code, the causes of the past 4 alarms. Further, it is also possible to display alarm information that indicates the status of the inverter when the alarm condition occurred. Figure 3.11 shows the status transition of the alarm information and Table 3.19 lists the details of the alarm information.

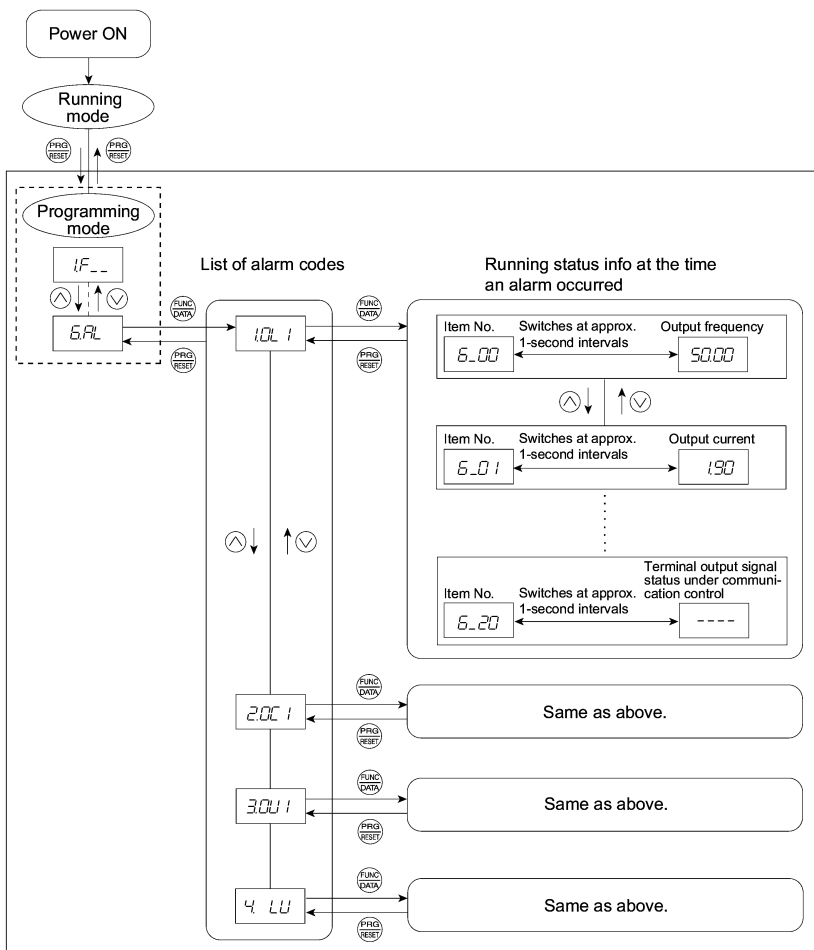

Figure 3.11 "Alarm Information" Status Transition

Basic key operation

Before viewing alarm information, set function code E52 to "2" (full-menu mode).











- (1) When the inverter is powered on, it automatically enters Running mode. In Running mode, press the  key to enter Programming mode. The menu for function selection will be displayed.
- (2) With the menu displayed, use the  and  keys to select "Alarm information" (E.P.L.).
- (3) Press the  key to display the alarm list code (e.g. 1.01).
In the list of alarm codes, the alarm information for the last 4 alarms is saved as an alarm history.
- (4) Each time the  or  key is pressed, the last 4 alarms are displayed in order from the most recent one as 1, 2, 3, and 4.
- (5) While the alarm code is displayed, press the  key to have the corresponding alarm item number (e.g. 5.00) and data (e.g. Output frequency) displayed alternately in intervals of approximately 1 second. You can also have the item number (e.g. 5.01) and data (e.g. Output current) for any other item displayed using the  and  keys.
- (6) Press the  key to return to the alarm list. Press the  key again to return to the menu.

Table 3.19 Alarm Information Displayed

LED monitor shows: (item No.)	Contents	Description
5_00	Output frequency	Output frequency
5_01	Output current	Output current
5_02	Output voltage	Output voltage
5_04	Reference frequency	Reference frequency
5_05	Rotational direction	This shows the running direction being output. F: forward; R: reverse; ---: stop
5_06	Running status	This shows the running status in hexadecimal. Refer to Displaying running status in [3] "Monitoring the running status."
5_07	Cumulative running time	Shows the cumulative power-ON time of the inverter. Unit: thousands of hours. When the total ON-time is less than 10000 hours (display: 0.001 to 9.999), data is shown in units of one hour. When the total time is 10000 hours or more (display: 10.00 to 65.53), it is shown in units of 10 hours. When the total time exceeds 65535 hours, the display will be reset to 0 and the count will start again.
5_08	No. of startups	The cumulative total number of times an inverter run command has been issued is calculated and displayed. 1.000 indicates 1000 times. When any number ranging from 0.001 to 9.999 is displayed, the display increases by 0.001 per startup, and when any number from 10.00 to 65.53 is displayed, the display increases by 0.01 every 10 startups. When the total number exceeds 65535, the display will be reset to 0 and the count will start again.
5_09	DC link bus voltage	Shows the DC link bus voltage of the inverter's main circuit. Unit: V (volts)

Table 3.19 Continued

LED monitor shows: (item No.)	Contents	Description
E_11	Max. temperature of heat sink	Shows the temperature of the heat sink. Unit: °C
E_12	Terminal I/O signal status (displayed with the ON/OFF of LED segments)	Shows the ON/OFF status of the digital I/O terminals. Refer to " Displaying control I/O signal terminals " in [4] "Checking I/O signal status" for details.
E_13	Signal input terminal status (in hexadecimal format)	
E_14	Terminal output signal status (in hexadecimal format)	
E_15	No. of consecutive occurrences	This is the number of times the same alarm occurs consecutively.
E_16	Overlapping alarm 1	Simultaneously occurring alarm codes (1) (- - - - is displayed if no alarms have occurred.)
E_17	Overlapping alarm 2	Simultaneously occurring alarm codes (2) (- - - - is displayed if no alarms have occurred.)
E_18	Terminal I/O signal status under communication control (displayed with the ON/OFF of LED segments)	Shows the ON/OFF status of the digital I/O terminals under RS-485 communication control. Refer to " Displaying control I/O signal terminals under communication control " in [4] "Checking I/O signal status" for details.
E_19	Terminal input signal status under communication control (in hexadecimal format)	
E_20	Terminal output signal status under communication control (in hexadecimal format)	



When the same alarm occurs a number of times in succession, the alarm information for the first occurrence is retained and the information for the subsequent occurrences is discarded. Only the number of consecutive occurrences will be updated.



3.2.3 Alarm mode

When an abnormal condition occurs, the protective function is invoked to issue an alarm, and the inverter automatically enters Alarm mode. At the same time, an alarm code appears on the LED monitor.

■ Releasing the Alarm and Transferring the Inverter to Running Mode



Remove the cause of the alarm and press the  key to release the alarm and return to Running mode. The alarm can be removed using the  key only when the current alarm code is displayed.

■ Displaying the Alarm History



It is possible to display the most recent 3 alarm codes in addition to the one currently displayed. Previous alarm codes can be displayed by pressing the  or  key while the current alarm code is displayed.

■ Displaying the Status of Inverter at the time of Alarm

If an alarm occurs, you may check various running status information (output frequency and output current, etc.) by pressing the  key when the alarm code is displayed. The item number and data for each running information is displayed in alternation.

Further, you can view various pieces of information on the status of the inverter using the  or  key. The information displayed is the same as for Menu #6 "Alarm information" in Programming mode. Refer to Table 3.19 in Section 3.2.2 [6] "Reading alarm information."

Pressing the  key while the status information is displayed returns the display to the alarm codes.

 **Note** When the status information is displayed after removal of the alarm cause, pressing the  key twice will take you back to the display of the alarm code, and then the inverter will be released from the alarm state. If a run command has been received by this time, the motor will start running.

■ Transit to Programming Mode

You can also go back to Programming mode by pressing the $\text{STOP} + \text{FUNC/RESET}$ keys simultaneously while the alarm is displayed, and modify the setting of function codes.

Figure 3.12 summarizes the possible transitions between different menu items.

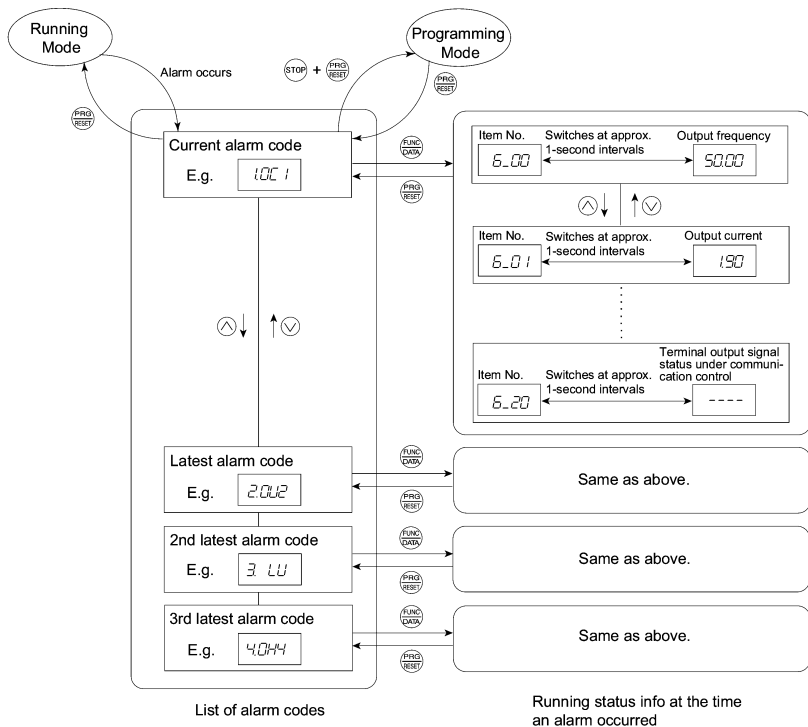

Figure 3.12 Alarm Mode Status Transition

Chapter 4 RUNNING THE MOTOR

4.1 Running the Motor for a Test

4.1.1 Inspection and preparation prior to the operation

Check the following prior to starting the operation.

- (1) Check if connection is correct.

Especially check if the power wires are connected to inverter output terminals U, V and W and that the grounding wire is connected to the ground electrode correctly.

WARNING

- Do not connect power supply wires to the inverter output terminals U, V, and W. Otherwise, the inverter may be broken if you turn the power on.
- Be sure to connect the grounding wires of the inverter and the motor to the ground electrodes. **Otherwise, electric shock may occur.**

- (2) Check for short circuits between terminals and exposed live parts and ground faults.
- (3) Check for loose terminals, connectors and screws.
- (4) Check if the motor is separated from mechanical equipment.
- (5) Turn the switches off so that the inverter does not start or operate erroneously at power-on.
- (6) Check if safety measures are taken against runaway of the system, e.g., a defense to protect people from unexpectedly approaching your power system.

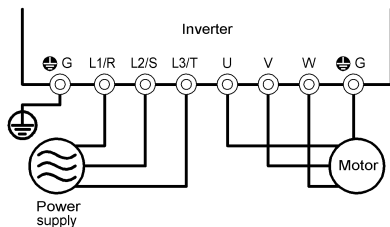

<for three-phase power supply>
Figure 4.1 Connection of Main Circuit Terminals
(Three-phase power supply)

4.1.2 Turning on power and checking

WARNING

- Be sure to install the covers for both the main circuit terminal block and control circuit terminal block before turning the power on. Do not remove the cover during power application.
- Do not operate switches with wet hands. **Otherwise electric shock could occur.**

Turn the power on and check the following points. This is a case when no function code data is changed from the factory setting.

- (1) Check that the LED monitor displays *0.00* (meaning that the reference frequency is 0 Hz) that is blinking. (See Figure 4.2.)
If the LED monitor displays numbers except *0.00*, then rotate the potentiometer to set *0.00* as the reference frequency.
- (2) Check if a built-in cooling fan rotates (for models with 1.5 kW or more).



Figure 4.2 Display of the LED Monitor after Power-on

4.1.3 Preparation before running the motor for a test--Setting function code data

Before starting running the motor, set function code data specified in Table 4.1 to the motor ratings and your system design values. For the motor, check the rated values printed on the nameplate of the motor. For your system design values, ask system designers about them.

 For details about how to change function code data, refer to Chapter 3, Section 3.2.2 "Programming mode [1] Setting the Function Codes." If the motor capacity is different from the inverter capacity, refer to Chapter 5, function code H03.

Table 4.1 Settings of Function Code Data before Driving the Motor for a Test

Function code	Name	Function code data	Factory setting
<i>F 04</i>	Base frequency	Motor ratings (printed on the nameplate of the motor)	60.0 (50.0) (Hz) (Note)
<i>F 05</i>	Rated Voltage (at base frequency)		0 (V) (Output voltage interlocked with the source voltage)
<i>P 02</i>	Motor Parameter (Rated capacity)		Applicable motor rated capacity
<i>P 03</i>	Motor Parameter (Rated current)		Rated current of applicable motor
<i>P 99</i>	Motor Selection		0: Characteristic of motor, 0 (Fuji standard 8-series motors)
<i>F 03</i>	Maximum frequency	System design values * For a test-driving of the motor, increase values so that they are longer than your system design values. If the set time is short, the inverter may not start running the motor.	60.0 (50.0) (Hz) (Note)
<i>F 07</i>	Acceleration time 1*		6.00 (s)
<i>F 08</i>	Deceleration time 1*		6.00 (s)

(Note) Values in parentheses () in the above table denote default settings for the EU version except three-phase 200 V class series.

4.1.4 Test run

WARNING

If the user set the function codes wrongly or without completely understanding this Instruction Manual and the FRENIC-Mini User's Manual (MEH446), the motor may rotate with a torque or at a speed not permitted for the machine.



Accident or injury may result.

Follow the descriptions given in Section 4.1.1, "Inspection and Preparation prior to the Operation" to Section 4.1.3, "Preparation before running the motor for a test," and begin test-driving of the motor.

CAUTION

If any abnormality is found to the inverter or motor, immediately stop operation and determine the cause referring to Chapter 6, "TROUBLESHOOTING."

----- Procedure for Test Run -----

- (1) Turn the power on and check that the LED monitor blinks while indicating the  Hz frequency.
- (2) With the built-in potentiometer clockwise, set a low frequency such as 5 Hz. (Check that the frequency displayed on the LED monitor blinks.)
- (3) Press the  key to start running the motor in the forward direction. (Check that the reference frequency is displayed on the LED monitor correctly.)
- (4) To stop the motor, press the  key.

<Check the following points>

- Check if the direction of rotation is correct.
- Check for smooth rotation without motor humming or excessive vibration.
- Check for smooth acceleration and deceleration.

When no abnormality is found, rotate the potentiometer clockwise to raise the reference frequency. Check the above points for the test-driving of the motor.

4.2 Operation

After confirming that the inverter normally drives the motor in a test run, make mechanical connections (connections to the machine system) and electrical connections (wiring and cabling), and configure the necessary function codes properly before starting a production run.

 **Note** Depending on the production run conditions, further adjustments can be required, such as adjustments of torque boost (F09), acceleration time (F07/E10), and deceleration time (F08/E11).

Chapter 5 FUNCTION CODES

5.1 Function Code Tables







Function codes enable the FRENIC-Mini series of inverters to be set up to match your system requirements.

Each function code consists of a 3-letter string. The first letter is an alphabet that identifies its group and the following two letters are numerals that identify each individual code in the group. The function codes are classified into seven groups: Fundamental Functions (F codes), Extension Terminal Functions (E codes), Control Functions of Frequency (C codes), Motor Parameters (P codes), High Performance Functions (H codes), Application Functions (J codes), and Link Function (y codes). To determine the property of each function code, set data to the function code.

The following descriptions supplement those given in the function code tables on page 5-3 and subsequent pages.

■ Changing, validating, and saving function code data when the motor is running

Function codes are indicated by the following based on whether they can be changed or not when the inverter is running:

Notation	Change when running	Validating and saving function code data
Y*	Possible	If the data of the codes marked with Y* is changed, the change will immediately take effect; however, the change is not saved into the inverter's memory. To save the change, press the  key. If you press the  key without pressing the  key to exit the current state, then the changed data will be discarded and the previous data will take effect for the inverter operation.
Y	Possible	The data of the codes marked with Y can be changed with the  and  keys regardless of whether the motor is running or not. Pressing the  key will make the change effective and save it into the inverter's memory.
N	Impossible	—

■ Copying data

Connecting a remote keypad (option) to an inverter via the RS-485 communications card (option) allows copying the data stored in the inverter's memory into the keypad's memory (refer to Menu #7 "Data copying" in Programming mode). With this feature, you can easily transfer the data saved in a source inverter to other destination inverters.

If the specifications of the source and destination inverters differ, some code data may not be copied to ensure safe operation of your power system. Therefore, you need to set up the uncopied code data individually as necessary. Whether data will be copied or not is detailed with the following symbols in the "Data copy" column of the function code tables given below.

Y: Will be copied unconditionally.

Y1: Will not be copied if the rated capacity differs from the source inverter.

Y2: Will not be copied if the rated input voltage differs from the source inverter.

N: Will not be copied. (The function code marked "N" is not subject to the Verify operation, either.)

It is recommended that you set up those function codes which are not subject to the Copy operation individually using Menu #1 "Data setting" as necessary.

 Refer to the Remote Keypad Instruction Manual (INR-SI47-0843-E) for details.

■ Using negative logic for programmable I/O terminals

The negative logic signaling system can be used for the digital input and output terminals by setting the function code data specifying the properties for those terminals. Negative logic refers to the inverted ON/OFF (logical value 1 (true)/0 (false)) state of input or output signal. An active-ON signal (the function takes effect if the terminal is short-circuited.) in the normal logic system is functionally equivalent to active-OFF signal (the function takes effect if the terminal is opened.) in the negative logic system. An active-ON signal can be switched to active-OFF signal, and vice versa, with the function code data setting.

To set the negative logic system for an I/O terminal, enter data of 1000s (by adding 1000 to the data for the normal logic) in the corresponding function code. Some signals cannot switch to active-OFF depending upon their assigned functions.

Example: "Coast to a stop" command **BX** assigned to any of digital input terminals [X1] to [X3] using any of function codes E01 through E03

Function code data	BX
7	Turning BX ON causes the motor to coast to a stop. (Active ON)
1007	Turning BX OFF causes the motor to coast to a stop. (Active OFF)





■ Restriction on data displayed on the LED monitor

Only four digits can be displayed on the 4-digit LED monitor. If you enter more than 4 digits of data valid for a function code, any digits after the 4th digit of the set data will not be displayed, however they will be processed correctly.

The following tables list the function codes available for the FRENIC-Mini series of inverters.

 If you find any [-] (not available here) mark in the related page column of the function code tables, refer to FRENIC-Mini User's manual (MEH446) for details.

F codes: Fundamental Functions

Code	Name	Data setting range	Incr- ment	Unit	Change when running	Data copy	Default setting	Refer to:
F00	Data Protection	0: Disable data protection (Function code data can be edited.) 1: Enable data protection (Function code data cannot be edited.)	—	—	Y	N	0	5-13
F01	Frequency Command 1	0:  /  keys on the built-in keypad 1: Voltage input to terminal [12] 2: Current input to terminal [C1] 3: Sum of voltage and current inputs to terminals [12] and [C1] 4: Built-in potentiometer (POT)	—	—	N	Y	4	5-13
F02	Operation Method	0:  /  keys on the built-in keypad (Motor rotational direction specified by terminal command FWD / REV) 1: Terminal command FWD or REV 2:  /  keys on the built-in keypad (forward) 3:  /  keys on the built-in keypad (reverse)	—	—	N	Y	2	5-14
F03	Maximum Frequency	25.0 to 400.0	0.1	Hz	N	Y	60.0 (50.0)* ¹	5-15
F04	Base Frequency	25.0 to 400.0	0.1	Hz	N	Y	60.0 (50.0)* ¹	5-15
F05	Rated Voltage at Base Frequency	0: Output a voltage in proportion to input voltage 80 to 240: Output an AVR-controlled voltage * ³ (Note 1) 160 to 500: Output an AVR-controlled voltage * ³ (Note 2)	1	V	N	Y2	0	5-15
F07	Acceleration Time 1	0.00 to 3600 Note: Entering 0.00 cancels the acceleration time, requiring external soft-start.	0.01	s	Y	Y	6.00	5-17
F08	Deceleration Time 1	0.00 to 3600 Note: Entering 0.00 cancels the deceleration time, requiring external soft-start.	0.01	s	Y	Y	6.00	5-17
F09	Torque Boost	0.0 to 20.0 (percentage with respect to "F05: Rated Voltage at Base Frequency") Note: This setting takes effect when F37 = 0, 1, 3, or 4.	0.1	%	Y	Y	Fuji's * ² standard torque boost	5-18
F10	Electronic Thermal Overload Protection for Motor (Select motor characteristics)	1: For a general-purpose motor with shaft-driven cooling fan 2: For an inverter-driven motor, non-ventilated motor, or motor with separately powered cooling fan	—	—	Y	Y	1	5-21
F11	(Overload detection level)	0.00 (Disable) 1 to 135% of rated the current (allowable continuous drive current) of the motor	0.01	A	Y	Y1 Y2	Nominal rated current of Fuji standard motor	5-21

*1 Values in parentheses () in the above table denote default settings for the EU version except three-phase 200 V class series of inverters.

*2 "Fuji's standard torque boost," "Nominal rated current of Fuji standard motor," and "Nominal rated capacity of Fuji standard motor" differ depending upon the rated input voltage and rated capacity. Refer to Table 5.1 "Fuji Standard Motor Parameters" on page 5-12.

*3 AVR: Automatic Voltage Regulator

(Note 1) For the three-phase 200 V, single-phase 200 V, and single-phase 100 V class series

(Note 2) For the three-phase 400 V class series

Code	Name	Data setting range	Increment	Unit	Change when running	Data copy	Default setting	Refer to:
F12	(Thermal time constant)	0.5 to 75.0	0.1	min	Y	Y	5.0	5-21
F14	Restart Mode after Momentary Power Failure (Mode selection)	0: Disable restart (Trip immediately) 1: Disable restart (Trip after recovery from power failure) 4: Enable restart (Restart at the frequency at which the power failure occurred, for general load) 5: Enable restart (Restart at the starting frequency, for low-inertia load)	—	—	Y	Y	1 (0)* ¹	5-21
F15	Frequency Limiter (High)	0.0 to 400.0	0.1	Hz	Y	Y	70.0	5-23
F16	(Low)	0.0 to 400.0	0.1	Hz	Y	Y	0.0	5-23
F18	Bias (Frequency command 1)	-100.00 to 100.00	0.01	%	Y*	Y	0.00	5-24
F20	DC Braking (Braking starting frequency)	0.0 to 60.0	0.1	Hz	Y	Y	0.0	5-25
F21	(Braking level)	0 to 100 (Rated output current of the inverter interpreted as 100%.)	1	%	Y	Y	0	5-25
F22	(Braking time)	0.00 (Disable), 0.01 to 30.00	0.01	s	Y	Y	0.00	5-25
F23	Starting Frequency	0.1 to 60.0	0.1	Hz	Y	Y	1.0	5-27
F25	Stop Frequency	0.1 to 60.0	0.1	Hz	Y	Y	0.2	5-27
F26	Motor Sound (Carrier frequency)	0.75 to 15	1	kHz	Y	Y	2 (15)* ¹	5-27
F27	(Tone)	0: Level 0 1: Level 1 2: Level 2 3: Level 3	—	—	Y	Y	0	5-27
F30	Analog Output [FMA] (Voltage adjustment)	0 to 200 If 100 is set, +10 VDC will be output from [FMA] at full scale.	1	%	Y*	Y	100	5-28
F31	(Function)	0: Output frequency 1 (before slip compensation) Maximum output frequency at full scale 1: Output frequency 2 (after slip compensation) Maximum output frequency at full scale 2: Output current Two times the inverter's rated output current at full scale 3: Output voltage 250 V (500 V) at full scale 6: Input power Two times the inverter's rated output capacity at full scale 7: PID feedback amount Feedback amount is 100% at full scale 9: DC link bus voltage 500 VDC (for 200 V class series), 1000 VDC (for 400 V class series) at full scale 14: Calibration If F30 = 100, +10 VDC at full scale	—	—	Y	Y	0	5-28

*1 Values in parentheses () in the above table denote default settings for the EU version except the three-phase 200 V class series of inverters.

Code	Name	Data setting range	Incr- ment	Unit	Change when running	Data copy	Default setting	Refer to:
F37	Load Selection/ Auto Torque Boost/ Auto Energy Saving Operation	0: Variable torque load 1: Constant torque load 2: Auto-torque boost 3: Auto-energy saving operation (Variable torque load during acceleration and deceleration) 4: Auto-energy saving operation (Constant torque load during acceleration and deceleration) 5: Auto-energy saving operation (Auto-torque boost during acceleration and deceleration)	—	—	N	Y	1	5-18
F43	Current Limiter (Mode selection)	0: Disable 1: In constant speed (Disable during acceleration and deceleration) 2: At acceleration and in constant speed (Disable during deceleration)	—	—	Y	Y	2 * ⁴	5-29
F44	(Level)	20 to 200 (The data is interpreted as the rated output current of the inverter for 100%.)	1	%	Y	Y	180 * ⁴	5-29
F50	Electronic Thermal Overload Protection for Braking Resistor (Discharging capability)	0: (To be set for braking resistor built-in type) 1 to 900 999: (Disable)	1	kWs	Y	Y	999/0 * ⁵	5-30
F51	(Allowable average loss)	0.000: Applied for built-in braking resistor, 0.001 to 50.000	0.001	kW	Y	Y	0.000	5-30

*4 Default settings for inverters with ROM version C1S11299 or earlier: F43 = 0 and F44 = 200 (For the ROM version checking procedure, refer to Chapter 3, Section 3.2.2 [5] "Reading maintenance information.")

*5 The default setting of function code F50 is 999 for standard models, and 0 for braking resistor built-in type.

E codes: Extension Terminal Functions

Code	Name	Data setting range	Incr- ment	Unit	Change when running	Data copy	Default setting	Refer to:
E01	Terminal [X1] Function	Selecting function code data assigns the corresponding function to terminals [X1] to [X3] as listed below. Setting the value of 1000s in parentheses () shown below assigns a negative logic input to a terminal.	—	—	N	Y	0	5-34
E02	Terminal [X2] Function		—	—	N	Y	7	5-34
E03	Terminal [X3] Function	0: (1000) Select multi-frequency (0 to 1 steps) (SS1) 1: (1001) Select multi-frequency (0 to 3 steps) (SS2) 2: (1002) Select multi-frequency (0 to 7 steps) (SS4) 4: (1004) Select ACC/DEC time (2 steps) (RT1) 6: (1006) Enable 3-wire operation (HLD) 7: (1007) Coast to a stop (BX) 8: (1008) Reset alarm (RST) 9: (1009) Enable external alarm trip (THR) 10: (1010) Ready for jogging (JOG) 11: (1011) Select frequency command 2/1 (Hz2/Hz1) 19: (1019) Enable data change with keypad (WE-KP) 20: (1020) Cancel PID control (Hz/PID) 21: (1021) Switch normal/inverse operation (IVS) 24: (1024) Enable communications link via RS-485 (option) (LE) 33: (1033) Reset PID integral and differential components (PID-RST) 34: (1034) Hold PID integral component (PID-HLD)	—	—	N	Y	8	5-34

Code	Name	Data setting range	Increment	Unit	Change when running	Data copy	Default setting	Refer to:
E10	Acceleration Time 2	0.00 to 3600	0.01	s	Y	Y	6.00	—
E11	Deceleration Time 2	0.00 to 3600	0.01	s	Y	Y	6.00	—
E20	Terminal [Y1] Function	Selecting function code data assigns the corresponding function to terminals [Y1] and [30A/B/C] as listed below. Setting the value of 1000s in parentheses () shown above assigns a negative logic input to a terminal. 0: (1000) Inverter running (RUN) 1: (1001) Frequency arrival signal (FAR) 2: (1002) Frequency level detection (FDT) 3: (1003) Undervoltage detected (LU) 5: (1005) Inverter output limiting (IOL) 6: (1006) Auto-restart after momentary power failure (IPF) 7: (1007) Motor overload early warning (OL) 26: (1026) Auto-resetting (TRY) 30: (1030) Service lifetime alarm (LIFE) 35: (1035) Inverter output on (RUN2) 36: (1036) Overload prevention control (OLP) 37: (1037) Current detected (ID) 41: (1041) Low level current detected (IDL) 99: (1099) Alarm output (for any alarm) (ALM)	—	—	N	Y	0	5-38
E27	Terminal [30A/B/C] Function		—	—	N	Y	99	5-38
E31	Frequency Detection (FDT) (Detection level)	0.0 to 400.0	0.1	Hz	Y	Y	60.0 (50.0) ^{*1}	—
E34	Overload Early Warning/ Current Detection/ Low Current Detection (Level)	0 (Disable) Current value of 1 to 200% of the rated inverter current	0.01	A	Y	Y1 Y2	Nominal rated current of Fuji standard motor ^{*2}	—
E35	Current Detection/ Low Current Detection (Timer)	0.01 to 600.00	0.01	s	Y	Y	10.00	—
E39	Coefficient for Constant Feeding Rate Time	0.000 to 9.999	0.001	—	Y	Y	0.000	5-41
E40	PID Display Coefficient A	-999 to 0.00 to 999	0.01	—	Y	Y	100	—
E41	PID Display Coefficient B	-999 to 0.00 to 999	0.01	—	Y	Y	0.00	—
E43	LED Monitor (Item selection)	0: Speed monitor (Select by E48.) 3: Output current 4: Output voltage 9: Input power 10: PID process command 12: PID feedback amount 13: Timer value (Timer operation)	—	—	Y	Y	0	—
E45	(Note)							
E46								
E47								
E48	LED Monitor (Speed monitor item)	0: Output frequency (Before slip compensation) 1: Output frequency (After slip compensation) 2: Reference frequency 4: Load shaft speed in r/min 5: Line speed in m/min 6: Constant feeding rate time	—	—	Y	Y	0	—



*1 Values in parentheses () in the above table denote default settings for the EU version except the three-phase 200 V class series of inverters.

*2 "Fuji's standard torque boost," "Nominal rated current of Fuji standard motor," and "Nominal rated capacity of Fuji standard motor" differ depending upon the rated input voltage and rated capacity. Refer to Table 5.1 "Fuji Standard Motor Parameters" on page 5-12.

(Note) Function codes E45 to E47 appear on the LED monitor; however, the FRENIC-Mini series of inverters does not recognize these codes.

Code	Name	Data setting range	Increase	Unit	Change when running	Data copy	Default setting	Refer to:
E50	Coefficient for Speed Indication	0.01 to 200.00	0.01	—	Y	Y	30.00	5-41
E52	Keypad (Menu display mode)	0: Function code data editing mode 1: Function code data check mode 2: Full-menu mode	—	—	Y	Y	0	5-41
E60	Built-in Potentiometer (Function selection)	0: None 1: Auxiliary frequency command 1 2: Auxiliary frequency command 2 3: PID process command 1	—	—	N	Y	0	—
E61	Terminal [12] Extended Function	Selecting function code data assigns the corresponding function to terminals [12] and [C1] as listed below.	—	—	N	Y	0	—
E62	Terminal [C1] Extended Function	0: None 1: Auxiliary frequency command 1 2: Auxiliary frequency command 2 3: PID process command 1 5: PID feedback amount	—	—	N	Y	0	—
E98	Terminal [FWD] Function	Selecting function code data assigns the corresponding function to terminals [FWD] and [REV] as listed below. Setting the value of 1000s in parentheses () shown above assigns a negative logic input to a terminal.	—	—	N	Y	98	5-34
E99	Terminal [REV] Function	0: (1000) Select multi-frequency (0 to 1 steps) (SS1) 1: (1001) Select multi-frequency (0 to 3 steps) (SS2) 2: (1002) Select multi-frequency (0 to 7 steps) (SS4) 4: (1004) Select ACC/DEC time (2 steps) (RT1) 6: (1006) Enable 3-wire operation (HLD) 7: (1007) Coast to a stop (BK) 8: (1008) Reset alarm (RST) 9: (1009) Enable external alarm trip (THR) 10: (1010) Ready for jogging (JOG) 11: (1011) Select frequency command 2/1 (Hz2/Hz1) 19: (1019) Enable data change with keypad (WE-KP) 20: (1020) Cancel PID control (Hz/PID) 21: (1021) Switch normal/inverse operation (IVS) 24: (1024) Enable communications link via RS-485 (option) (LE) 33: (1033) Reset PID integral and differential components (PID-RST) 34: (1034) Hold PID integral component (PID-HLD) 98: Run forward (FWD) 99: Run reverse (REV)	—	—	N	Y	99	5-34

C codes: Control Functions of Frequency

Code	Name	Data setting range	Increment	Unit	Change when running	Data copy	Default setting	Refer to:
C01	Jump Frequency 1	0.0 to 400.0	0.1	Hz	Y	Y	0.0	—
C02	2					Y	0.0	—
C03	3					Y	0.0	—
C04	Jump Frequency Hysteresis Width	0.0 to 30.0	0.1	Hz	Y	Y	3.0	—
C05	Multi-frequency 1	0.00 to 400.00	0.01	Hz	Y	Y	0.00	—
C06	2					Y	0.00	—
C07	3					Y	0.00	—
C08	4					Y	0.00	—
C09	5					Y	0.00	—
C10	6					Y	0.00	—
C11	7					Y	0.00	—
C20	Jogging Frequency	0.00 to 400.00	0.01	Hz	Y	Y	0.00	—
C21	Timer Operation	0: Disable 1: Enable	—	—	N	Y	0	5-42
C30	Frequency Command 2	0:  /  keys on the built-in keypad 1: Voltage input to terminal [12] 2: Current input to terminal [C1] 3: Sum of voltage and current inputs to terminals [12] and [C1] 4: Built-in potentiometer (POT)	—	—	N	Y	2	5-13
C32	Analog Input Adjustment for [12] (Gain)	0.00 to 200.00	0.01	%	Y*	Y	100.0	5-24
C33	(Filter time constant)	0.00 to 5.00	0.01	s	Y	Y	0.05	—
C34	(Gain base point)	0.00 to 100.00	0.01	%	Y*	Y	100.0	5-24
C37	Analog Input Adjustment for [C1] (Gain)	0.00 to 200.00	0.01	%	Y*	Y	100.0	5-24
C38	(Filter time constant)	0.00 to 5.00	0.01	s	Y	Y	0.05	—
C39	(Gain base point)	0.00 to 100.00	0.01	%	Y*	Y	100.0	5-24
C50	Bias (Frequency command 1) (Bias base point)	0.00 to 100.00	0.01	%	Y*	Y	0.00	5-24
C51	Bias (PID command 1) (Bias value)	-100.00 to 100.00	0.01	%	Y*	Y	0.00	—
C52	(Bias base point)	0.00 to 100.00	0.01	%	Y*	Y	0.00	—

P codes: Motor Parameters

Code	Name	Data setting range	Increment	Unit	Change when running	Data copy	Default setting	Refer to:
P02	Motor Parameters (Rated capacity)	0.01 to 10.00 kW (where, P99 data is 0, 3, or 4.) 0.01 to 10.00 HP (where, P99 data is 1.)	0.01 0.01	kW HP	N	Y1 Y2	Nominal [*] rated capacity of Fuji standard motor	5-43
P03	(Rated current)	0.00 to 99.99	0.01	A	N	Y1 Y2	Nominal [*] rated current of Fuji standard motor	5-43
P09	(Slip compensation gain)	0.0 to 200.0 Typical rated slip frequency at 100%	0.1	%	Y*	Y	0.0	5-43
P14	No-load Current (Note)	0.00 (Default value) 0.01 to 99.99	0.01	A	N	Y1 Y2	0.00	—
P99	Motor Selection	0: Motor characteristics 0 (Fuji standard motors, 8-series) 1: Motor characteristics 1 (HP rating motors) 3: Motor characteristics 3 (Fuji standard motors, 6-series) 4: Other motors	—	—	N	Y1 Y2	0	5-43

H codes: High Performance Functions

Code	Name	Data setting range	Increment	Unit	Change when running	Data copy	Default setting	Refer to:
H03	Data Initialization	0: Disable initialization 1: Initialize all function code data to the factory defaults 2: Initialize motor parameters	—	—	N	N	0	5-44
H04	Auto-reset (Times)	0: Disable 1 to 10	1	Times	Y	Y	0	5-47
H05	(Reset interval)	0.5 to 20.0	0.1	s	Y	Y	5.0	5-47
H06	Cooling Fan ON/OFF Control	0: Disable 1: Enable (1.5 kW or more)	—	—	Y	Y	0	—
H07	Acceleration/ Deceleration Pattern	0: Disable (Linear) 1: S-curve (Weak) 2: S-curve (Strong) 3: Curvilinear	—	—	Y	Y	0	5-48
H12	Instantaneous Overcurrent Limiting	0: Disable 1: Enable	—	—	Y	Y	1	5-48
H26	Thermistor (Mode selection)	0: Disable 1: Enable (PTC)	—	—	Y	Y	0	—
H27	(Level)	0.00 to 5.00	0.01	V	Y	Y	1.60	—
H30	Communications Link Function (Mode selection)	Monitor Frequency command source Run command source 0: Y N N 1: Y RS-485 N 2: Y N RS-485 3: Y RS-485 RS-485 Y: Enable by inverter and via RS-485 communication (option) RS-485: Enable via RS-485 communication (option) N: Enable by inverter	—	—	Y	Y	0	—
H42	Capacitance of DC Link Bus	Indication for replacing DC link bus capacitor	—	—	—	N	—	—
H43	Cumulative Run Time of Cooling Fan	Indication of cumulative run time of cooling fan for replacement	—	—	—	N	—	—

*2 "Fuji's standard torque boost," "Nominal rated current of Fuji standard motor," and "Nominal rated capacity of Fuji standard motor" differ depending upon the rated input voltage and rated capacity. Refer to Table 5.1 "Fuji Standard Motor Parameters" on page 5-12.

(Note) Function code P14 is valid on inverters with ROM version C1S11100 or later. (The lowest four digits of the ROM version can be displayed on the LED monitor. For details, refer to Chapter 3, Section 3.2.2 [5] "Reading Maintenance Information.")

Code	Name	Data setting range	Increment	Unit	Change when running	Data copy	Default setting	Refer to:
H50	Non-linear V/f Pattern (Frequency)	0.0 (Cancel), 0.1 to 400.0	0.1	Hz	N	Y	0.0	5-15
H51	(Voltage)	0 to 240: Output voltage AVR-controlled for 200 V class motors 0 to 500: Output voltage AVR-controlled for 400 V class motors	1	V	N	Y2	0	5-15
H54	ACC/DEC Time (Jogging operation)	0.00 to 3600	0.01	s	Y	Y	6.00	—
H64	Low Limiter (Lower limiting frequency)	0.0 (Depends on F16 : Freq. limiter (low)), 0.1 to 60.0	0.1	Hz	Y	Y	2.0	—
H69	Automatic Deceleration (Mode selection)	0: Disable 1: Enable	—	—	Y	Y	0	5-49
H70	Overload Prevention Control	0.00 (Follow deceleration time specified by F08/E11), 0.01 to 100.00, 999 (Cancel)	0.01	Hz/s	Y	Y	999	5-49
H71	(Note 1)							
H80	Output Current Fluctuation Damping Gain for Motor	0.00 to 0.20	0.01	—	Y	Y	0.20	—
H95	DC Braking (Note 2) (Braking response mode)	0: Slow 1: Quick	—	—	Y	Y	0 (1) ^{*6}	5-25
H96	STOP Key Priority/ Start Check Function	STOP key priority Start check function 0: Disable Disable 1: Enable Disable 2: Disable Enable 3: Enable Enable	—	—	Y	Y	0	5-49
H97	Clear Alarm Data	0: Do not clear alarm data 1: Clear alarm data and return to zero	—	—	Y	N	0	5-50
H98	Protection/ Maintenance Function (Mode selection)	opL Lin ADFCF 0: Disable Disable Disable 1: Disable Disable Enable 2: Disable Enable Disable 3: Disable Enable Enable 4: Enable Disable Disable 5: Enable Disable Enable 6: Enable Enable Disable 7: Enable Enable Enable opL: Output Phase Loss Protection Lin: Input Phase Loss Protection ADFCF: Automatic DEC Function for Carrier Frequency Note: For single-phase power input inverters, Lin is always invalid regardless of H98 setting.	—	—	Y	Y	3	5-50

*6 The value in parentheses () for H95 denotes the default setting for the EU version. If initialized by H03, the H95 data reverts to "1" in the EU version.

(Note 1) Function code H71 appears on the LED monitor; however, the FRENIC-Mini series of inverters does not recognize this code.

(Note 2) Function code H95 is valid on inverters with ROM version C1S11000 or later. (The lowest four digits of the ROM version can be displayed on the LED monitor. For details, refer to Chapter 3, Section 3.2.2 [5] "Reading maintenance information.")

J codes: Application Functions

Code	Name	Data setting range	Increment	Unit	Change when running	Data copy	Default setting	Refer to:
J01	PID Control (Mode Selection)	0: Disable 1: Enable (Process control, normal operation) 2: Enable (Process control, inverse operation)	—	—	N	Y	0	—
J02	(Remote process command)	0: / keys on keypad 1: PID process command 1 (Data settings of E60, E61 and E62 are also required.) 4: Command via communications link	—	—	N	Y	0	—
J03	P (Gain)	0.000 to 10.00	0.001	Times	Y	Y	0.100	—
J04	I (Integral time)	0.0 to 3600.0	0.1	s	Y	Y	0.0	—
J05	D (Differential time)	0.00 to 600.00	0.01	s	Y	Y	0.00	—
J06	(Feedback filter)	0.0 to 900.0	0.1	s	Y	Y	0.5	—

y codes: Link Functions

Code	Name	Data setting range	Increment	Unit	Change when running	Data copy	Default setting	Refer to:
y01	RS-485 Communication (Station address)	1 to 255	1	—	N	Y	1	—
y02	(Communications error processing)	0: Immediately trip with alarm $E-rB$ 1: Trip with alarm $E-rB$ after running for the period specified by timer y03 2: Retry during the period specified by timer y03. If the retry fails, trip with alarm $E-rB$. If it succeeds, continue to run. 3: Continue to run	—	—	Y	Y	0	—
y03	(Timer)	0.0 to 60.0	0.1	s	Y	Y	2.0	—
y04	(Baud rate)	0: 2400 bps 1: 4800 bps 2: 9600 bps 3: 19200 bps	—	—	Y	Y	3	—
y05	(Data length)	0: 8 bits 1: 7 bits	—	—	Y	Y	0	—
y06	(Parity check)	0: None 1: Even parity 2: Odd parity	—	—	Y	Y	0	—
y07	(Stop bits)	0: 2 bits 1: 1 bit	—	—	Y	Y	0	—
y08	(No response error detection time)	0 (No detection), 1 to 60	1	s	Y	Y	0	—
y09	(Response interval)	0.00 to 1.00	0.01	s	Y	Y	0.01	—
y10	(Protocol selection)	0: Modbus RTU protocol 1: SX protocol (Loader protocol) 2: Fujii general-purpose inverter protocol	—	—	Y	Y	1	—
y99	Loader Link Function (Mode selection)	Frequency command Run command 0: Follow H30 data Follow H30 data 1: Via RS-485 link Follow H30 data (Loader) (option) 2: Follow H30 data Via RS-485 link (Loader) (option) 3: Via RS-485 link Via RS-485 link (Loader) (option) (Loader) (option)	—	—	Y	N	0	—

* The table below lists the factory settings of "Fuji's standard torque boost," "Nominal rated current of Fuji standard motor," and "Nominal rated capacity of Fuji standard motor" in the "Default setting" column of the above tables.

Table 5.1 Fuji Standard Motor Parameters

Power supply voltage	Nominal applied motor (kW)	Inverter type	Fuji's standard torque boost (%)	Nominal rated current of Fuji standard motor (A)			Nominal rated capacity of Fuji standard motor (kW)
			Function code F09	Function codes F11, E34 and P03			Function code P02
				Shipping destination (version)			
				Asia	EU	Japan	
Three-phase 200 V	0.1	FRN0.1C1■-2□	8.4	0.62	0.68	0.61	0.1
	0.2	FRN0.2C1■-2□	8.4	1.18	1.30	1.16	0.2
	0.4	FRN0.4C1■-2□	7.1	2.10	2.30	2.13	0.4
	0.75	FRN0.75C1■-2□	6.8	3.29	3.60	3.36	0.75
	1.5	FRN1.5C1■-2□**	6.8	5.55	6.10	5.87	1.5
	2.2	FRN2.2C1■-2□**	6.8	8.39	9.20	8.80	2.2
	3.7	FRN3.7C1■-2□**	5.5	13.67	15.00	14.38	3.7
Three-phase 400 V	0.4	FRN0.4C1■-4□	7.1	1.09	1.15	1.07	0.4
	0.75	FRN0.75C1■-4□	6.8	1.71	1.80	1.68	0.75
	1.5	FRN1.5C1■-4□**	6.8	3.04	3.05	2.94	1.5
	2.2	FRN2.2C1■-4□**	6.8	4.54	4.60	4.40	2.2
	3.7	FRN3.7C1■-4□**	5.5	7.43	7.50	7.20	3.7
	4.0	FRN4.0C1■-4□**					
Single-phase 200 V	0.1	FRN0.1C1■-7□	8.4	0.62	0.68	0.61	0.1
	0.2	FRN0.2C1■-7□	8.4	1.18	1.30	1.16	0.2
	0.4	FRN0.4C1■-7□	7.1	2.10	2.30	2.13	0.4
	0.75	FRN0.75C1■-7□	6.8	3.29	3.60	3.36	0.75
	1.5	FRN1.5C1■-7□	6.8	5.55	6.10	5.87	1.5
	2.2	FRN2.2C1■-7□	6.8	8.39	9.20	8.80	2.2
Single-phase 100 V	0.1	FRN0.1C1■-6□	8.4	0.62	0.68	0.61	0.1
	0.2	FRN0.2C1■-6□	8.4	1.18	1.30	1.16	0.2
	0.4	FRN0.4C1■-6□	7.1	2.10	2.30	2.13	0.4
	0.75	FRN0.75C1■-6□	6.8	3.29	3.60	3.36	0.75

Note 1) A box (■) in the above table replaces S or E depending on the enclosure.

2) A box (□) in the above table replaces A, C, E, or J depending on the shipping destination.

3) Asterisks (**) in the above table denote the following:





- 21: Braking resistor built-in type (Available for inverters with 1.5 kW or above)
None: Standard

5.2 Overview of Function Codes

This section provides an overview of the function codes frequently used for the FRENIC-Mini series of inverter.



 For details about the function codes given below and other function codes not given below, refer to the FRENIC-Mini User's Manual (MEH446), Chapter 9 "FUNCTION CODES" and the RS-485 Communication User's Manual (MEH448).

F00 Data Protection

Specifies whether function code data is to be protected from being accidentally changed by keypad operation. If data protection is enabled (F00 = 1),  or  key operation to change data is disabled so that no function code data, except F00 data, can be changed from the keypad. To change F00 data, simultaneous keying of  +  keys is required.

F01, C30 Frequency Command 1 and 2

F01 or C30 sets the source that specifies reference frequency 1 or reference frequency 2, respectively.

Set F01 to:	To do this
0	Enable the  and  keys on the built-in keypad. (Refer to Chapter 3 "OPERATION USING THE KEYPAD.")
1	Enable the voltage input to terminal [12] (0 to +10 VDC, maximum frequency obtained at +10 VDC).
2	Enable the current input to terminal [C1] (+4 to +20 mA DC, maximum frequency obtained at +20 mA DC).
3	Enable the sum of voltage and current inputs to terminals [12] and [C1]. See the two items listed above for the setting range and maximum frequencies. Note: If the sum exceeds the maximum frequency, the maximum frequency will apply.
4	Enable the built-in potentiometer (POT). (Maximum frequency obtained at full scale of the POT)



 • There are other frequency command means (such as the communications facility, multi-frequency, etc.) with higher priority than that of F01. Refer to the FRENIC-Mini User's Manual (MEH446), Chapter 4, Section 4.2 "Drive Frequency Command Generator" for more details.

 • For frequency commands by terminals [12] (voltage) and [C1] (current) and by the built-in potentiometer, setting the gain and bias changes the relationship between those frequency commands and the drive frequency to enable matching your system requirements. Refer to function code F18 for details.

• For the inputs to terminals [12] (voltage) and [C1] (current), low-pass filters can be enabled. Refer to the FRENIC-Mini User's Manual (MEH446), Chapter 9, "FUNCTION CODES" for details.



In addition to "F01 Frequency set 1," "C30: Frequency set 2" is available. To switch between them, use the terminal command **H_z2/H_z1**. For details of the **H_z2/H_z1**, refer to "E01 to E03, E98, and E99: Command Assignment to Terminals [X1] to [X3], [FWD], and [REV]."







Selects a source issuing a run command—keypad or external control signal input.

- If F02 = 0, 2, or 3, the inverter can run the motor by the  and  keys on the built-in keypad. The motor rotational direction can be specified in two ways, either by control signal input (F02 = 0) or by use of prefixed forward or reverse rotation (F02 = 2 or 3).

When F02 = 0, to specify the motor rotational direction by control signal input, assign the commands **FWD** and **REV** to terminals [FWD] and [REV], respectively. Turn on the **FWD** or **REV** for the forward or reverse direction, respectively, and then press the  key to run the motor.

- If F02 = 1, the inverter can run the motor by control signal inputs. To specify the motor rotational direction, assign the commands **FWD** and **REV** to terminals [FWD] and [REV], respectively. Turn on the **FWD** or **REV** for the forward or reverse direction, respectively. If both of **FWD** and **REV** are turned on simultaneously, the inverter immediately decelerates to stop the motor.

The table below lists the operational relationship between function code F02 (Running/Stopping and Rotational Direction), the  and  key operation, and control signal inputs to terminals [FWD] and [REV], which determines the rotational direction.

Function code F02:	Key on the keypad	Control signal inputs to terminals [FWD] and [REV]		Motor rotational direction
		Function code E98 FWD command	Function code E99 REV command	
0	 key	OFF	OFF	Stop
		ON	OFF	Forward
		OFF	ON	Reverse
		ON	ON	Stop
	 key	OFF	OFF	Stop
		ON	OFF	
		OFF	ON	
		ON	ON	
1	Ignored.	OFF	OFF	Stop
		ON	OFF	Forward
		OFF	ON	Reverse
		ON	ON	Stop
2 (forward/ fixed)	 key	Ignored.		Forward
	 key			Stop
3 (reverse/ fixed)	 key	Ignored.		Reverse
	 key			Stop

- Note**
- If you have assigned the **FWD** or **REV** function to the [FWD] or [REV] terminal, you cannot change the setting of function code F02 while the terminals [FWD] and [CM]* or the terminals [REV] and [CM]* are short-circuited.
 - If you have specified the external signal (F02 = 1) as the running command and have assigned functions other than the **FWD** or **REV** function to the [FWD] or [REV] terminal, caution should be exercised in changing the settings. Because, if under this condition you assign the **FWD** or **REV** function to the [FWD] or [REV] terminal while the terminals [FWD] and [CM]* or the terminals [REV] and [CM]* are short-circuited, the motor would start running.
- *[CM] replaces with [PLC] for SOURCE mode.

F03 Maximum Frequency

Sets the maximum frequency to drive the motor. Setting the frequency out of the range rated for the equipment driven by the inverter may cause damage or a dangerous situation. Set a maximum frequency appropriate for the equipment. For high-speed motors, it is recommended that the carrier frequency be set to 15 kHz.

CAUTION

The inverter can easily set high-speed operation. When changing the speed setting, carefully check the specifications of motors or equipment beforehand.

Otherwise injuries could occur.

- Tip** If you modify the data of F03 to apply a higher drive frequency, concurrently change the data of F15 for a peak frequency limiter suitable to the drive frequency.

F04	Base Frequency
F05	Rated Voltage at Base Frequency
H50	Non-linear V/f Pattern (Frequency)
H51	Non-linear V/f Pattern (Voltage)

These function codes set the base frequency and the voltage at the base frequency essentially required for running the motor properly. If combined with the related function codes H50 and H51, these function codes may set data needed to drive the motor along the non-linear V/f pattern.

The following description includes setting-up required for the non-linear V/f pattern.

■ Base frequency (F04)

Set the rated frequency printed on the nameplate located on the motor.

■ Rated voltage at base frequency (F05)

Set 0 or the rated voltage printed on the nameplate labeled on the motor.

- If 0 is set, the inverter supplies voltage equivalent to that of the power source of the inverter at the base frequency. In this case, the output voltage will vary in line with any variance in input voltage.
- If the data is set to anything other than 0, the inverter automatically keeps the output voltage constant in line with the setting. When any of the automatic torque boost settings, automatic energy saving or slip compensation is active, the voltage settings should be equal to the rating of the motor.

Note If F05 is set to match the rated voltage of the motor, motor efficiency will be better than that it is set to 0. Therefore, when brakes are applied to the motor, energy loss decreases and the motor regenerates larger braking energy, which can easily cause the overvoltage protection function ($\overline{U} > U_n$ where $n = 1$ to 3) to be activated. Note that the allowable power consumption capacity of the inverter for braking energy is limited by the specifications. If the overvoltage protection function is activated, it may be necessary to increase deceleration time or use an external braking resistor.

■ Non-linear V/f pattern for frequency (H50)

Sets the non-linear V/f pattern for frequency component.

(Setting 0.0 to H50 disables the non-linear V/f pattern operation.)

■ Non-linear V/f pattern for voltage (H51)

Sets the non-linear V/f pattern for voltage component.

If the rated voltage at base frequency (F05) is set to 0, the data settings of function codes H50 and H51 will be ignored.

Note If you set the data of H50 to 25 Hz or lower (Operation under low base frequency), the inverter output voltage may be limited.

Defining non-linear V/f patterns (F04, F05, H50 and H51)

Function codes F04 and F05 define a non-linear V/f pattern that forms the relationship between the inverter's output frequency and voltage.

Furthermore, setting the non-linear V/f pattern using function codes H50 and H51 allows patterns with higher or lower voltage than that of the normal pattern to be defined at an arbitrary point inside or outside the base frequency. Generally, when a motor is driven at a high speed, its internal impedance may increase and output torque may decrease due to the decreased drive voltage. This feature helps you solve that problem. Note that setting the voltage in excess of the inverter's input source voltage is not allowed. (For the single-phase 100 V class series, setting the voltage that is two times or more the inverter's input source voltage is not allowed.)

■ Normal (linear) V/f pattern

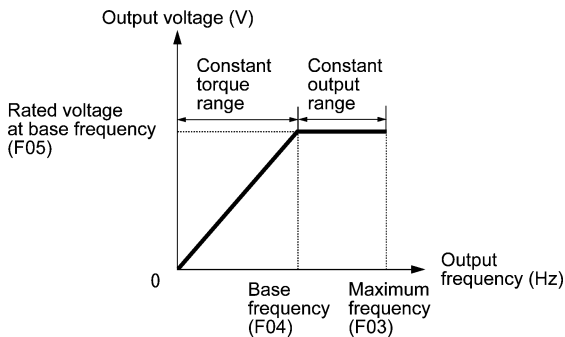

- V/f pattern with single non-linear point inside the base frequency

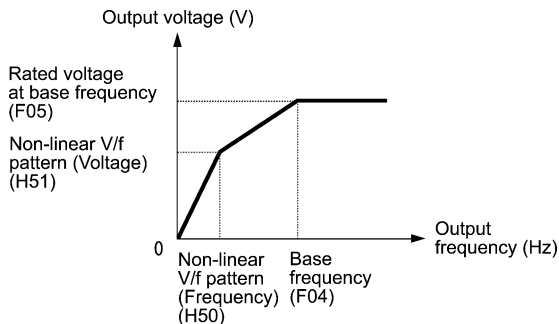

Tip You can also set the optional non-linear V/f range (H50: Frequency) for frequencies exceeding the base frequency (F40).

F07
F08

Acceleration Time 1, Deceleration Time 1

The acceleration time specifies the length of time the frequency increases from 0 Hz to the maximum frequency. The deceleration time specifies the length of time the frequency decreases from the maximum frequency down to 0 Hz.

- In case the reference frequency is equal to the maximum frequency (F03)

The actual acceleration and deceleration times are the same as the specified acceleration time and deceleration time.

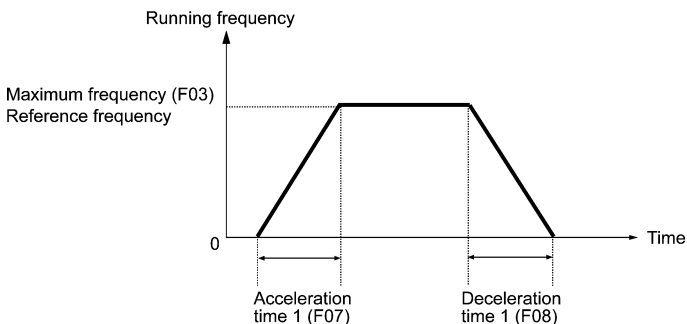

- In case the reference frequency is lower than the maximum frequency (F03)

The actual acceleration and deceleration times are shorter than the specified acceleration time and deceleration time.

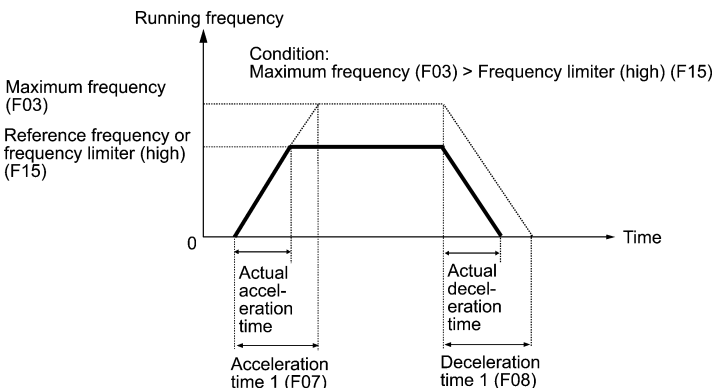

$$\text{Actual acceleration/ deceleration time} = \frac{\text{Reference frequency}}{\text{Maximum frequency (F03)}} \times (\text{Acceleration time 1 (F07) or Deceleration time 1 (F08)})$$

- Note**
- If you choose S-curved acceleration/deceleration or curvilinear acceleration/deceleration in "curvilinear acceleration/deceleration" (H07), the actual acceleration/deceleration times are longer than the specified times.
 - If you specify an improperly short acceleration/deceleration time, then the current limiting function or the automatic deceleration function may be activated, resulting in an actual acceleration/deceleration time longer than the specified one.

F09
F37

Torque Boost
Load Selection/Auto Torque Boost/Auto Energy Saving Operation

In general, there are two different properties of loads--the variable torque load (fans and pumps) and the constant torque load (industrial machinery). You can select a V/f pattern optimized to the load property.

Manual torque boost

In manual torque boost mode, the inverter maintains the output at a constant level regardless of the load. When you use this mode, select the appropriate V/f pattern (variable torque or constant torque characteristics) with Load Selection (F37). To keep the motor starting torque, manually select optimal inverter output voltage for the motor and load by setting an optimal torque boost rate to F09 in accordance with the motor and its load.

Setting an excessive torque boost rate may result in over-excitation and overheat of the motor during light or no load operation.

Manual torque boost keeps the output voltage constant even if the load varies, assuring stable motor operation.

Variable torque characteristics (F37 = 0)

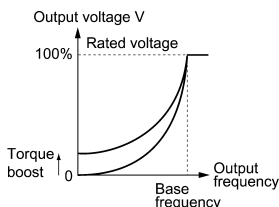

Constant torque characteristics (F37 = 1)

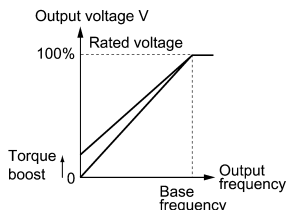

- Note**
- Set an appropriate torque boost rate that will keep the starting torque of the motor within the voltage level in the low frequency zone. Setting an excessive torque boost rate may result in over-excitation or overheat of the motor during no load operation.
 - The F09 data setting is effective when F37 (Load Selection/Auto Torque Boost/Auto Energy Saving Operation) is set to 0, 1, 3, or 4.

Automatic torque boost

This feature automatically optimizes the output voltage to fit the motor and its load. Under a light load, it decreases the output voltage to prevent the motor from over-excitation; under a heavy load, it increases the output voltage to increase torque.

Since this feature is related to the motor properties, it is necessary to set the rated voltage at base frequency (F05) and motor parameters (P codes) properly.

- Note**
- For the automatic torque boost feature, which is related to the motor characteristics, you need to consistently set the voltage at the base frequency (F05) and motor parameters P02, P03 and P99 appropriately for the motor rating and characteristics.

Auto energy saving operation

This feature controls the terminal voltage of the motor automatically to minimize the motor power loss. (Note that this feature may not be effective depending upon the motor characteristics. Check the characteristics before using this feature.)

The inverter enables this feature for constant speed operation only. During acceleration and deceleration, the inverter will run with manual or automatic torque boost, depending on function code F37. If auto energy saving operation is enabled, the response to a change in motor speed may be slow. Do not use this feature for a system that requires quick acceleration and deceleration.

Note Use auto-energy saving only where the base frequency is 60 Hz or lower. If the base frequency is higher than 60 Hz, then you may get little or no energy saving effect.

The auto energy saving operation is designed for use with the frequency lower than the base frequency. If the frequency becomes higher than the base frequency, the auto energy saving operation will be invalid.

For the auto energy saving function, which is related to the motor characteristics, you need to consistently set the voltage at the base frequency (F05) and motor parameters P02, P03 and P99 appropriately for the motor rating and characteristics.

Given below are examples of proper setting in combination with F09 and F37.

■ If you do not select auto energy saving operation

Load type	To select manual torque boost, set:	To select automatic torque boost, set:
Variable torque	F37 = 0 F09 = 0.0 to 20.0 (%)	F37 = 2
Constant torque	F37 = 1 F09 = 0.0 to 20.0 (%)	

■ If you select auto energy saving operation

Load type	To select manual torque boost, set:	To select automatic torque boost, set:
Variable torque	F37 = 3 F09 = 0.0 to 20.0 (%)	F37 = 5
Constant torque	F37 = 4 F09 = 0.0 to 20.0 (%)	

F10 to F12 Electronic Thermal Overload Protection for Motor
(Select motor characteristics, Overload detection level, and Thermal time constant)

F10 through F12 specify the thermal characteristics of the motor for its electronic thermal overload protection that is used to detect overload conditions of the motor inside the inverter.

F10 selects the motor cooling mechanism to specify its characteristics, F11 specifies the overload detection current, and F12 specifies the thermal time constant.

 **Note** Thermal characteristics of the motor specified by these function codes are also used for the overload early warning. Therefore, even if you need only the overload early warning, set these characteristics data to function codes F10 and F12.

F10 selects the cooling mechanism of the motor--shaft-driven or separately powered cooling fan.

Data for F10	Function
1	For a general-purpose motor with shaft-driven cooling fan (The cooling effect will decrease in low frequency operation.)
2	For an inverter-driven motor, non-ventilated motor, or motor with separately powered cooling fan (The cooling effect will be kept constant regardless of the output frequency.)

F11 specifies the level at which an overload condition is to be recognized. Ordinarily, set F11 to 1.0 to 1.1 times the allowable continuous current (rated current of the motor (P03)) at the rated drive frequency (base frequency) of the motor. To disable the electronic thermal function, set F11 to 0.00 (no effect).

F12 sets the thermal time constant of the motor. The inverter interprets the time constant as an operation period of the electronic thermal function. During the specified operation period, the inverter will activate the electronic thermal function if 150% current of the operation level specified by F11 flows continuously. The time constant of Fuji general-purpose motors and other induction motors is set to approximately 5 minutes by factory default.

Data entry range: 0.5 to 75.0 (minutes, in 0.1-minute increment)

 Refer to the FRENIC-Mini User's Manual (MEH446), Chapter 9 "FUNCTION CODES" for details of the shaft-driven cooling fan and characteristics of the electronic thermal function.

F14 Restart Mode after Momentary Power Failure

Selects the action of the inverter to be followed when a momentary power failure occurs.

If the inverter detects that the DC link bus voltage has dropped to less than the specified undervoltage limit during operation, it interprets the state as an occurrence of a momentary power failure. However, if the inverter runs with a light load connected to the motor and the period of the power failure is too short, then it may not detect the power failure and continue to run.

- Trip immediately (F14 = 0)

If a momentary power failure occurs when the inverter is in Running mode so that the inverter detects undervoltage of the DC link bus, then the inverter immediately stops its output and displays the undervoltage alarm $\angle\angle\angle$ on the LED monitor. The motor will coast to a stop and the inverter will not restart automatically.

- Trip after recovery from power failure (F14 = 1)

If a momentary power failure occurs when the inverter is in Running mode, causing the inverter to detect undervoltage of the DC link bus, the inverter immediately stops its output without transferring to Alarm mode or displaying the undervoltage alarm $\angle\angle\angle$. The motor will coast to a stop. When the power is recovered, the inverter will enter Alarm mode for undervoltage with displaying the alarm $\angle\angle\angle$. The motor will be still coasting.

- Restart at the frequency at which the power failure occurred (F14 = 4)

If a momentary power failure occurs when the inverter is in Running mode so that the inverter detects undervoltage of the DC link bus, then the inverter saves the current output frequency and stops its output to make the motor to coast to a stop. When the power is recovered with any run command being on, the inverter will restart at the saved frequency.

During the momentary power failure, if the motor speed slows down, the current limiter function of the inverter will be activated and automatically lower the output frequency. Upon synchronization of the output frequency and motor speed, the inverter accelerates up to the previous output frequency. Refer to the figure (F14 = 4) given below for details.

To synchronize the output frequency and motor speed, however, the momentary overcurrent limiter (H12 = 1) should be enabled.

This setting is optimal for operations in which the motor speed rarely slows down due to the heavy moment of inertia of its load even if the motor coasts to a stop because of the momentary power failure.

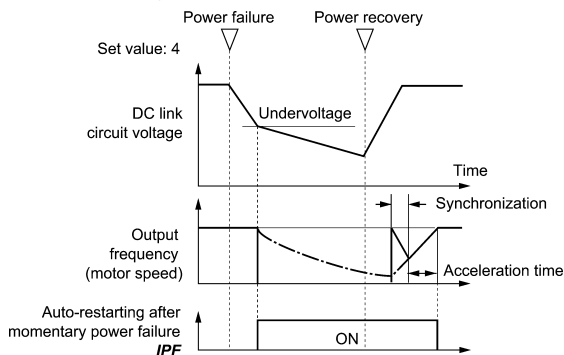

- Restart at the starting frequency (F14 = 5)

If a momentary power failure occurs when the inverter is in Running mode so that the inverter detects undervoltage of the DC link bus, then the inverter immediately stops its output. After the power is recovered, entry of any run command will restart the inverter at the frequency specified by function code F23.

This setting is optimal for operations in which the motor speed quickly slows down to 0 r/min due to the heavy load with a very small moment of inertia if the motor coasts to a stop because of the momentary power failure.

- Note**
- There is a 0.5-second delay from detection of the undervoltage until the motor is restarted. This delay is due to the time required for the residual electricity (magnetic flux) in the motor to drop sufficiently. Therefore, even if the momentary power failure period is shorter than 0.5 second, a delay of at least 0.5 second is required for the motor to restart.
 - When a momentary power failure occurs, the power supply voltage for external circuitry (such as relay circuits) controlling the inverter may also drop as low as to cause run commands to be discontinued. Therefore, during recovery from a momentary power failure, the inverter waits 2 seconds for a run command to arrive. If it receives one within 2 seconds, it will restart. If a run command arrives more than 2 seconds later, then the inverter should be restarted at the starting frequency (F23). The external circuitry should be so designed that it will issue a run command within 2 seconds in such an event; otherwise it should incorporate a relay with a mechanical locking feature.
 - If a coast-to-stop command **BX** is issued during the time from the detection of a momentary power failure to restart, the inverter exits from the state of waiting for restarting, and enters Running mode. If any run command is issued, the inverter will start at the starting frequency (F23) preset.

WARNING

If you select restart after momentary power failure (F14 = 4 or 5), the inverter will automatically restart running the motor when power is recovered. The machine should be so designed that human body and peripheral equipment safety is ensured even after automatic restarting.

Otherwise an accident could occur.

F15, F16 Frequency Limiter (High and Low)

Frequency limiter (high) F15 sets the upper limit of the output frequency, while frequency limiter (low) F16 sets the lower limit of the output, as shown below.

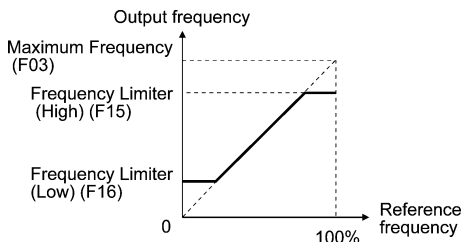

- Note**
- When you change the upper frequency limit (F15) in order to increase the running frequency, be sure to change the maximum frequency (F03) accordingly.
 - Maintain the following relationship among the parameters for frequency control:
 $F03 \geq F15 > F16 \geq F23 \geq F25$, or $F03 \geq F15 > F16 \geq F25 \geq F23$,
 where, F23 is the starting frequency and F25 is the stopping frequency.
 If the above relationship is not observed, then the motor may not operate (accelerate, decelerate, or stop) at the specified frequency.
 - If you specify the lower frequency limit (F16) above the upper frequency limit (F15), the upper frequency limit (F15) will be automatically selected and the lower limit (F16) will be ignored.

F18	Bias (Frequency command 1)
C50	Bias (Frequency command 1) (Bias base point)
C32, C34	Analog Input Adjustment for [12] (Gain and Gain base point)
C37, C39	Analog Input Adjustment for [C1] (Gain and Gain base point)

If you select any analog input for frequency set 1 (set by F01), you can define the relationship between the analog input and the reference frequency arbitrarily by combining the settings for bias (F18), bias base point (C50), gains (C32 and C37), and gain base points (C34 and C39).

As illustrated in the graph below, the relationship between the reference frequency and analog input level for frequency 1 is shown by a straight line passing through points "A" and "B". The point "A" is determined by the bias command (F18) and its reference point (C50). The point "B" is determined by the gain command (C32 or C37) and its base point (C34 or C39). The combination of C32 and C34 will apply for terminal [12] and that of C37 and C39 for terminal [C1].

The bias (F18) and gain (C32 or C37) should be set, assuming the maximum frequency as 100%. The bias base point (C50) and gain base point (C34 or C39) should be set, assuming the full scale (+10 VDC or +20 mA) as 100%.

- Note**
- Analog input under the bias base point is limited by the bias data.
 - If "bias base point (C50) \geq gain base point (C34/C39)," the inverter interprets the setting as invalid and sets the output frequency at 0 Hz.

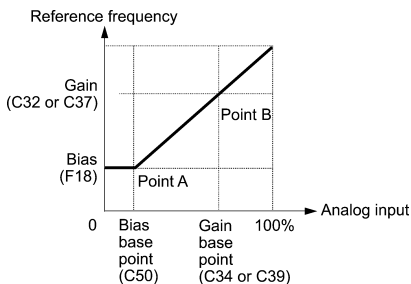

The relations stated above are indicated in the following expressions.

(1) If analog input \leq bias base point:
 Frequency Setting 1 (%) = Bias (F18)

(2) If analog input > bias base point:

$$\begin{aligned} & \text{Frequency Setting 1 (\%)} \\ &= \frac{(\text{Gain}) - (\text{Bias})}{(\text{Gain base point}) - (\text{Bias base point})} \times \text{Analog input} \\ &+ \frac{(\text{Bias}) \times (\text{Gain base point}) - (\text{Gain}) \times (\text{Bias base point})}{(\text{Gain base point}) - (\text{Bias base point})} \\ &= \frac{C32 - F18}{C34 - C50} \times \text{Analog input} + \frac{F18 \times C34 - C32 \times C50}{C34 - C50} \end{aligned}$$

In the above expressions, each function code expresses its data.

Example: Setting the bias, gain and their base points when analog input range from +1 to +5 VDC is selected for frequency command 1

(Point A)

If the analog input is at 1 V, to specify the reference frequency at 0 Hz, set the bias at 0% (F18 = 0). Since 1 V is the bias base point and it is equal to 10% of 10 V, then set the bias base point at 10% (C50 = 10).

(Point B)

If an analog input is at 5 V, then set the gain at 100% (C32 = 100) to keep frequency at the maximum value. Since 5 V is the gain base point and it is equal to 50% of 10 V, set the gain base point at 50% (C34 = 50).

Note When using the function codes for setting a gain or bias alone without changing any base points, the setting procedure for the function codes is the same as that of Fuji conventional inverter models (FVR-C9S, FVR-C11S, etc.).

F20 to F22 H95	DC Braking (Braking starting frequency, Braking level, and Braking time) DC Braking (Braking response mode)
-------------------	--

These function codes specify the parameters for DC braking, a mechanism to prevent the motor from coasting due to the inertia of moving loads while it is decelerating to a stop. During a decelerated stop cycle, i.e., when any Run command "OFF" has been issued or the reference frequency has dropped below the stopping frequency, DC braking is invoked as soon as the output frequency has reached the starting frequency (F20) for DC braking.

Set function codes F20 for the starting frequency, F21 for the braking level, and F22 for the braking time. Optionally, you can also select the quick-response DC braking with H95.

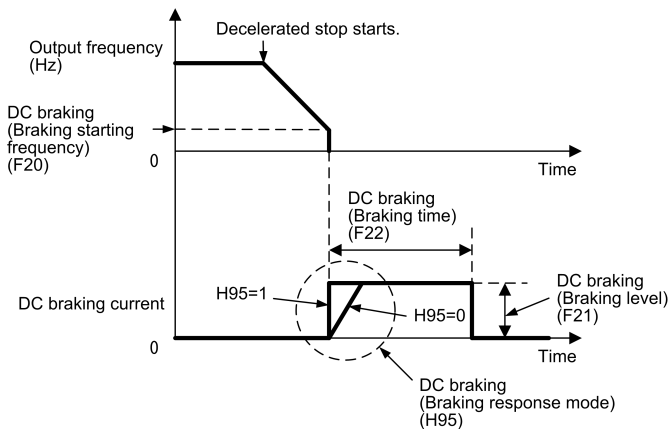

H95 specifies the DC braking response mode as follows:

If H95 is set to:	Braking mode	Meaning
0	Slow response	The DC braking current gradually ramps up. (The torque may not be sufficient at the start of DC braking.)
1	Quick response	The DC braking current quickly ramps up. (Depending on the inertia of the moving loads or the coupling state, the revolution may be unstable.)

Note For three-phase 200 V and single-phase 200 V/100 V class series inverters

The braking level setting for the three-phase 200 V and single-phase 200 V/100 V class series should be calculated from the DC braking level I_{DB} (A) based on the reference current I_{ref} (A), as shown below.

$$\text{Setting (\%)} = \frac{I_{DB} \text{ (A)}}{I_{ref} \text{ (A)}} \times 100$$

(Example) Setting the braking level I_{DB} at 4.2 Amp (A) for 0.75 kW standard motors

$$\text{Setting (\%)} = \frac{4.2 \text{ (A)}}{5.0 \text{ (A)}} \times 100 = 84$$

Nominal applied motor (kW)	0.1	0.2	0.4	0.75	1.5	2.2	3.7
Reference current I_{ref} (A)	0.8	1.5	3.0	5.0	8.0	11.0	17.0

⚠ CAUTION

The brake function of the inverter does not provide mechanical holding means.
Injuries could occur.

F23, F25 Starting Frequency and Stop Frequency

At the startup of an inverter, the initial output frequency is equal to the starting frequency. The inverter stops its output at the stop frequency.

Set the starting frequency to a level that will enable the motor to generate enough torque for startup. Generally, set the motor's rated slip frequency to F23.

 For how to set the rated slip frequency, see function code P09.

 **Note** If the starting frequency is lower than the stop frequency, the inverter will not output any power as long as the reference frequency does not exceed the stop frequency.

F26, F27 Motor Sound (Carrier frequency and Tone)

■ Motor Sound (Carrier frequency) (F26)

Changing the carrier frequency may decrease the motor running noise, leakage current from the output lines, and electric noise from the inverter.

Carrier frequency	0.75 to 15 kHz
Motor running noise	Noisy to quiet
Output current waveform	Poor to good
Leakage current level	Low to high
Electric noise level	Low to high

 **Note** Lowering the carrier frequency increases the ripple components (harmonic components) on the output current waveform so as to increase the motor's power loss and raises the temperature of the motor. If the carrier frequency is set at 0.75 kHz, for example, estimate the motor output torque at 85% or less of the rated motor torque.

On the contrary, raising the carrier frequency increases the inverter's power loss and raises the temperature of the inverter. The inverter has a built-in overload protection function that automatically decreases the carrier frequency to protect the inverter. For details about the function, refer to function code H98.

■ Motor Sound (Tone) (F27)

Changes the motor running sound tone. This setting is effective when the carrier frequency set to function code F26 is 7 kHz or lower. Changing the tone level may reduce the high and harsh running noise from the motor.

F31 allows you to output monitored data (such as the output frequency or output current) to terminal [FMA] as an analog DC voltage that can be adjusted with F30 for the meter scale.

■ Voltage adjustment (F30)

Adjust the output voltage level within the range of 0 to 200%, supposing the monitored amount of the monitor selected with function code F31 as 100%.

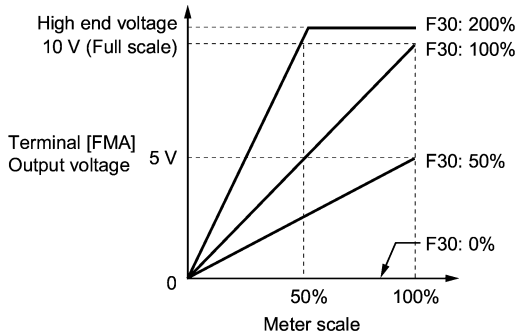

■ Function (F31)

F31 specifies what is output to the analog output terminal [FMA].



In the case of FRN4.0C1■-4□**, the actual output level for input power will be multiplied by 108% while the reference motor rating is 3.7 kW.

Note For three-phase 200 V and single-phase 200 V/100 V class series of inverters

Outputting the output current in an analog format (FMA) (F31 = 2)

The analog output terminal [FMA] outputs 10 V, that is, 200% of the reference current I_{ref} (A), supposing the output gain selected with F30 as 100%. Therefore, to adjust the output voltage, you need to set the output gain at terminal [FMA] (F30) based on the conversion result obtained by the following expression:

- Conversion formula for calculating the output gain which is required for outputting the voltage V (V) via terminal [FMA] when current I (A) flows across the inverter

$$\text{Output gain} = 2 \times \frac{I_{ref} \text{ (A)}}{I \text{ (A)}} \times \frac{V \text{ (V)}}{10 \text{ (V)}} \times 100$$

I_{ref} (A): Reference current (A)

 The reference current is given in the table for F20 to F22 on page 5-26.

According to the conversion result, the output voltage to terminal [FMA] can be calculated as shown below.

$$\text{Analog output voltage (V)} = \frac{I \text{ (A)}}{2 \times I_{ref} \text{ (A)}} \times \frac{\text{Output gain (F30)}}{100} \times 10 \text{ (V)}$$

(Example) Outputting analog voltage 8V for 0.75 kW standard motors when the inverter output current is 4.2A

$$\text{Output gain} = 2 \times \frac{5.0 \text{ (A)}}{4.2 \text{ (A)}} \times \frac{8 \text{ (V)}}{10 \text{ (V)}} \times 100 = 190.4$$

$$\text{Analog output voltage (V)} = \frac{4.2 \text{ (A)}}{2 \times 5.0 \text{ (A)}} \times \frac{190}{100} \times 10 \text{ (V)} = 7.98$$

Reference table

If you want to output analog 10 V at 200% of the rated current of any of the single-phase 100 V class series of inverters, set the output gain at terminal [FMA] (F30) as listed below.

Nominal applied motor (kW)	0.1	0.2	0.4	0.75
Output gain to be set to F30 (%)	114	107	120	119

F43, F44 Current Limiter (Mode selection and Level)

F43 enables or disables the current limiter. If it is enabled, the inverter controls the output frequency so that the output current of the inverter does not exceed the level set by F44. This way it prevents the motor from stalling and limits the output current below the set level.

With F43, you may select whether the current limiter works during constant speed operation only (F43 = 1) or during both acceleration and constant speed operation (F43 = 2). Set F43 to 1, for example, to drive the motor at maximum performance in the acceleration zone and to limit the drive current in the constant speed zone.

 **Note** For three-phase 200 V and single-phase 200 V/100 V class series inverters

The limiting level setting for the three-phase 200 V and single-phase 200 V/100 V class series should be calculated from the current limiting level I_{limit} (A) based on the reference current I_{ref} (A), as shown below.

$$\text{Setting (\%)} = \frac{I_{limit} \text{ (A)}}{I_{ref} \text{ (A)}} \times 100$$

(Example) Setting the current limiting level I_{limit} at 4.2 A for 0.75 kW standard motors

$$\text{Setting (\%)} = \frac{4.2 \text{ (A)}}{5.0 \text{ (A)}} \times 100 = 84$$

 The reference current is given in the table for F20 to F22 on page 5-26.

-  **Note**
- The current limiting feature selected by F43 and F44 are implemented by software, so an operational delay may occur. To avoid the delay, use the current limiter (hardware) simultaneously (H12 = 1).
 - If an overload is applied when the limiting level is set extremely low, the inverter will immediately lower its output frequency. This may cause an overvoltage trip or dangerous turnover of the motor rotation due to undershooting.

WARNING

If the current limiter function has been activated, the inverter may operate at an acceleration/deceleration time or frequency different from the set ones. The machine should be so designed that safety is ensured even in any current limiter operation.

Otherwise an accident could occur.

F50, F51

Electronic Thermal Overload Protection for Braking Resistor
(Discharging capability and Allowable average loss)

These function codes specify the electronic thermal overload protection feature for the braking resistor.

Set the discharging capability and allowable average loss of braking resistors to F50 and F51, respectively. Those values differ depending upon the specifications of the braking resistor. Refer to the tables on the next page.

For built-in braking resistors, you may set 0 and 0.000 to F50 and F51, respectively. Doing so will automatically apply the settings given in the table on the next page.

 Refer to the FRENIC-Mini User's Manual (MEH446), Chapter 7, Section 7.2 "Selecting a Braking Resistor" for details.

 **Note** Depending on the discharging capability margin of a braking resistor, the electronic thermal function may operate and issue the overheat alarm *oCh*, even if the actual temperature of the resistor is lower than that specified. Check braking resistor performance again and review the data setting of function codes F50 and F51.

The following tables list the discharging capability and allowable average loss of the FRENIC-Mini series inverters. These values are determined by inverter model and specifications (built-in or external type) of braking resistors.

■ Built-in braking resistor

Power supply voltage	Inverter type	Resistance (Ω)	Capacity (W)	Continuous braking (Braking torque: 100%)		Repetitive braking (Period: 100 sec. or less)	
				Discharging capability (kW)	Braking time (s)	Allowable average loss (kW)	Duty cycle (%ED)
Three-phase 200 V	FRN1.5C1 ■-2□21	60	40	14	18	0.023	3
	FRN2.2C1 ■-2□21				12		2
	FRN3.7C1 ■-2□21	40	60	15	8	0.025	1.5
Three-phase 400 V	FRN1.5C1 ■-4□21	240	40	14	18	0.023	3
	FRN2.2C1 ■-4□21				12		2
	FRN3.7C1 ■-4□21	160		15	8	0.025	1.5
	FRN4.0C1 ■-4□21						

Note 1) A box (■) in the above table replaces S or E depending on the enclosure.

2) A box (□) in the above table replaces A, C, E, or J depending on the shipping destination.

■ External braking resistor

Standard Models

The braking resistor is protected from overheating by a thermal relay incorporated in the braking resistor. Assign "Enable external alarm trip" **THR** to one of the inverter's digital input terminals [X1], [X2], [X3], [FWD], and [REV], and connect it to the terminals 2 and 1 of the braking resistor.

If you choose not to use the thermal relay incorporated in the braking resistor, set up the overheat protection device using the values given in the table below.

Power supply voltage	Inverter type	Braking resistor type	Q'ty	Resistance (Ω)	Capacity (W)	Continuous braking (Braking torque: 100%)		Repetitive braking (Period: 100 sec. or less)	
						Discharging capability (kW)	Braking time (s)	Allowable average loss (kW)	Duty cycle (%ED)
Three-phase 200 V	FRN0.4C1■-2□	DB0.75-2	1	100	200	9	45	0.044	22
	FRN0.75C1■-2□					17		0.068	18
	FRN1.5C1■-2□**	DB2.2-2		40	400	34	0.075	10	
	FRN2.2C1■-2□**					33	30	0.077	7
	FRN3.7C1■-2□**	DB3.7-2		33	37	20	0.093	5	
Three-phase 400 V	FRN0.4C1■-4□	DB0.75-4	200	200	9	45	0.044	22	
	FRN0.75C1■-4□				17		0.068	18	
	FRN1.5C1■-4□**	DB2.2-4	160	400	34	0.075	10		
	FRN2.2C1■-4□**				33	30	0.077	7	
	FRN3.7C1■-4□** FRN4.0C1■-4□**	DB3.7-4	130	37	20	0.093	5		
Single-phase 200 V	FRN0.4C1■-7□	DB0.75-2	1	100	200	9	45	0.044	22
	FRN0.75C1■-7□					17		0.068	18
	FRN1.5C1■-7□	DB2.2-2		40	400	34	0.075	10	
	FRN2.2C1■-7□					33	30	0.077	7
Single-phase 100 V	FRN0.4C1■-6□	DB0.75-2	100	200	9	45	0.044	22	
	FRN0.75C1■-6□				17		0.068	18	

Note 1) A box (■) in the above table replaces S or E depending on the enclosure.

2) A box (□) in the above table replaces A, C, E, or J depending on the shipping destination.

3) Asterisks (**) in the above table denote the following:

21: Braking resistor built-in type, None: Standard

10% ED Models

Power supply voltage	Inverter type	Braking resistor type	Q'ty	Resistance (Ω)	Capacity (W)	Continuous braking (Braking torque: 100%)		Repetitive braking (Period: 100 sec. or less)	
						Discharging capability (kW)	Braking time (s)	Allowable average loss (kW)	Duty cycle (%ED)
Three-phase 200 V	FRN0.4C1■-2□	DB0.75-2C	1	100	200	50	250	0.075	37
	FRN0.75C1■-2□						133		20
	FRN1.5C1■-2□**	DB2.2-2C		40	400	55	73	0.110	14
	FRN2.2C1■-2□**						50		10
	FRN3.7C1■-2□**	DB3.7-2C		33		140	75	0.185	10
Three-phase 400 V	FRN0.4C1■-4□	DB0.75-4C	200	200	50	250	0.075	37	
	FRN0.75C1■-4□					133		20	
	FRN1.5C1■-4□**	DB2.2-4C	160	400	55	73	0.110	14	
	FRN2.2C1■-4□**					50		10	
	FRN3.7C1■-4□**	DB3.7-4C	130		140	75	0.185	10	
	FRN4.0C1■-4□**								
Single-phase 200 V	FRN0.4C1■-7□	DB0.75-2C	1	100	200	50	250	0.075	37
	FRN0.75C1■-7□						133		20
	FRN1.5C1■-7□	DB2.2-2C		40	400	55	73	0.110	14
	FRN2.2C1■-7□						50		10
Single-phase 100 V	FRN0.4C1■-6□	DB0.75-2C	100	200	50	250	0.075	37	
	FRN0.75C1■-6□					133		20	

Note 1) A box (■) in the above table replaces S or E depending on the enclosure.

2) A box (□) in the above table replaces A, C, E, or J depending on the shipping destination.

3) Asterisks (**) in the above table denote the following:

21: Braking resistor built-in type, None: Standard

Function codes E01 to E03, E98 and E99 allow you to assign commands to terminals [X1] to [X3], [FWD], and [REV] which are general-purpose, programmable, digital input terminals.

These function codes may also switch the logic system between normal and negative to define how the inverter logic interprets either ON or OFF status of each terminal. The default setting is normal logic system "Active ON."

To assign negative logic input to any input terminal, set the function code to the value of 1000s shown in () in Section 5.1 "Function Code Tables." To keep explanations as simple as possible, the examples shown below are all written for the normal logic system.

- Select multi-frequency (1 to 7 steps)--**SS1**, **SS2**, and **SS4**
(Function code data = 0, 1, and 2)

The combination of the ON/OFF states of digital input signals **SS1**, **SS2**, and **SS4** selects one of 8 different frequency commands defined beforehand by 7 function codes C05 to C11 (Multi-frequency 0 to 7). With this, the inverter can drive the motor at 16 different preset frequencies.

The table below lists the frequencies that can be obtained by the combination of switching **SS1**, **SS2**, and **SS4**. In the "Selected frequency" column, "Other than multi-frequency" represents the reference frequencies defined by frequency command 1 (F01), frequency command 2 (C30), or others.

Terminal [X3] (E03)	Terminal [X2] (E02)	Terminal [X1] (E01)	Selected frequency
2 (SS4)	1 (SS2)	0 (SS1)	
OFF	OFF	OFF	Other than multi-frequency
OFF	OFF	ON	C05 (Multi-frequency 1)
OFF	ON	OFF	C06 (Multi-frequency 2)
OFF	ON	ON	C07 (Multi-frequency 3)
ON	OFF	OFF	C08 (Multi-frequency 4)
ON	OFF	ON	C09 (Multi-frequency 5)
ON	ON	OFF	C10 (Multi-frequency 6)
ON	ON	ON	C11 (Multi-frequency 7)

- Select ACC/DEC time (2 steps)--**RT1**
(Function code data = 4)

Digital input signal **RT1** assigned to the specified terminal on/off may switch combinations between acceleration/deceleration time 1 (defined by function codes F07 and F08) and acceleration/deceleration time 2 (defined by E10 and E11).

Turning **RT1** on, for example, enables the inverter to drive the motor using acceleration/deceleration time 2.

- Enable 3-wire operation--**HLD**
(Function code data = 6)

Digital input signal **HLD** may self-hold the forward **FWD**/ reverse **REV** run commands given at the external signal input terminals to enable 3-wire inverter operation.

Shorting the circuit between the **HLD**-assigned terminal and terminal [CM] (i.e., when **HLD** is ON) will self-hold the **FWD** or **REV** command. Opening the circuit will release the hold. When **HLD** is not assigned, 2-wire operation involving only **FWD** and **REV** takes effect.

- Coast to a stop--**BX**
(Function code data = 7)

Shorting the circuit between the **BX**-assigned terminal and terminal [CM] will immediately stop the inverter output so that the motor will coast to a stop without issuing any alarms.

- Reset alarm--**RST**
(Function code data = 8)

When the protection function has been activated (the inverter is in Alarm mode), shorting the circuit between the **RST**-assigned terminal and terminal [CM] will reset the alarm output on terminals [Y1] and [30A/B/C]. Opening the circuit will release all the alarm indications to restart operation. Allow 10 ms or more for the short-circuit time.

RST should be kept off for normal inverter operation.

- Enable external alarm trip--**THR**
(Function code data = 9)

When the motor is running, opening the circuit between the **THR**-assigned terminal and terminal [CM] will immediately stop the inverter output and issue the alarm **AL2**. The motor will coast to a stop.

- Ready for jogging--**JOG**
(Function code data = 10)

You can choose either one of jogging operations specified following:

- (1) When operated from keypad (F02 = 0, 2, or 3)

By state of  key on the keypad the motor becomes ready for:

ON	Start jogging
OFF	Stop jogging

- (2) When operated from the digital inputs ([FWD] and [REV]) (F02 = 1)



By state of the digital inputs [FWD] and [REV] the motor becomes ready for:

ON	Start jogging
OFF	Stop jogging







Jogging operation follows the settings of:

- Jogging frequency set by function code C20
- Acceleration or deceleration time set by function code H54

Simultaneous  +  keying may also make the motor ready for jogging depending upon whether keypad operation or terminal command operation is selected and whether the **JOG** command is on or off, as listed below.

When operated from keypad (F02 = 0, 2, or 3)

If JOG is:	 +  keys	The motor becomes ready for:
ON	Disabled.	Jogging
OFF	Toggles between normal and jogging.	Normal running
		Jogging

When terminal command operation is selected (F02 = 1), simultaneous  +  keying is disabled.

- Select frequency command 2/1--**H_z2/H_z1**
(Function code data = 11)

Turning the digital input signal **H_z2/H_z1** on/off may switch the frequency command means between frequency command 1 (defined by function code F01) and frequency command 2 (defined by function code C30).

Turning the **H_z2/H_z1** command on allows the frequency command 2 to be selected.

- Enable data change with keypad--**WE-KP**
(Function code data = 19)

Turning off the **WE-KP** command prohibits changing of function code data from the keypad.

Only when the **WE-KP** command is on, you may access function code data from the keypad according to the setting of function code F00 as listed below.

If WE-KP is set to:	Function code F00 data	Function
ON	0	Permit editing of function code data
	1	Inhibit editing of function code data except F00
OFF	Disabled	Inhibit editing of function code data

If the **WE-KP** command is not assigned to any terminal, the inverter will interpret **WE-KP** as being always on.

- Cancel PID control--**H_z/PID**
(Function code data = 20)

Turning the **H_z/PID** command on/off enables or disables the PID control.

If the PID control is disabled with the **H_z/PID** being off, the inverter runs the motor with the frequency manually set by any of multistep, keypad, or analog input.

 Refer to the FRENIC-Mini User's Manual (MEH446), Chapter 4, Section 4.8 "PID Frequency Command Generator" for details.

- Switch normal/inverse operation--**IVS**
(Function code data = 21)

Turning the **IVS** command on/off switches the output frequency control between normal (proportional to the reference frequency components) and inverse operation for the PID process or manually reference frequencies. To select the inverse operation, turn the **IVS** command on.

When the PID control is enabled, turning the **IVS** command on inverts the PID process control selected by function code J01. For example, if the PID process control is normal, turning it on switches it to inverse, or vice versa.

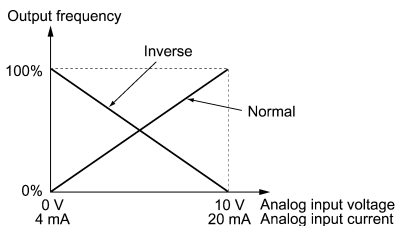

- Enable communications link via RS-485 (option)--**LE**
(Function code data = 24)

Turning this terminal command ON assigns priorities to frequency commands or run commands received via the RS-485 communications link (H30) (option).

No **LE** assignment is functionally equivalent to the **LE** being ON.

- Reset PID integral and differential components--**PID-RST**
(Function code data = 33)

Turning on the **PID-RST** command resets the PID integral and differential components.

- Hold PID integral component--**PID-HLD**
(Function code data = 34)

Turning on the **PID-HLD** command holds the current inverter output voltage constant by suppressing an increase of PID integral component.

- Run forward--**FWD**
(Function code E98/E99 data = 98)

If the **FWD** command is turned on, the inverter runs the motor forward; if off, it decelerates the motor to a stop.

- Run reverse--**REV**
(Function code E98/E99 data = 99)

If the **REV** is turned on, the inverter runs the motor in reverse; if off, it decelerates the motor to a stop.

E20 and E27 may assign output signals to terminals [Y1] (transistor switch) and [30A], [30B] and [30C] (mechanical relay contacts) which are general-purpose programmable output terminals.

These function codes may also switch the logic system between normal and negative to define how the inverter logic interprets either ON or OFF status of each terminal.

Terminals [30A], [30B], and [30C] are mechanical relay contacts. In the normal logic, if an alarm occurs, the relay will be ordinarily excited so that [30A] and [30C] will be short-circuited, signaling an occurrence of the error to external equipment. On the other hand, in the negative logic, the relay will cut off the excitation current to open [30A] and [30C]. This may be useful for the implementation of fail-safe power systems.

 **Note** If negative logic is active, powering off the inverter switches all output signals to the active side (for example, the alarm side). To avoid adversary effects caused by this, make an appropriate arrangement outside the inverter as necessary, for example, interlocking its operation with a power-on signal.

Since terminals [30A/B/C] are mechanical relay contacts, they cannot withstand frequent on/off operations. If frequent signal outputs are expected e.g., assigning any current limiter signal and activating the current limiter actively, then use [Y1]. For rare signal outputs, e.g., for inverter protection purpose, use [30A/B/C].

The service life of a mechanical relay contact is 200,000 on/off operations at one-second intervals.

To keep explanations as simple as possible, the examples shown below are all written for the normal logic system.

- Inverter running (Speed > 0)--**RUN**
(Function code data = 0)

This signal is turned on when the inverter is running at the starting frequency or higher.

- Frequency arrival signal--**FAR**
(Function code data = 1)

This signal is turned on when the difference between the output and reference frequencies comes into the allowable error zone (prefixed to 2.5 Hz).

- Frequency level detection--**FDT**
(Function code data = 2)

This signal is turned on when the output frequency of the inverter comes into the frequency detection level specified by function code E31. It is turned off when the output frequency drops lower than the detection level for 1 Hz (hysteresis band of the frequency comparator: prefixed at 1 Hz).

■ Undervoltage detected--**LU**
(Function code data = 3)

This signal is turned on when the DC link bus voltage of the inverter drops below the specified level or when the motor stops due to activation of the undervoltage protection feature (undervoltage trip). It is turned off if the DC link bus voltage exceeds the specified level.

■ Inverter output limiting--**IOL**
(Function code data = 5)

This signal is turned on when the inverter is limiting the motor drive current by activating the current limiter of either software (F43: Mode selection, F44: Level) or hardware (H12 = 1: Enable). The minimum ON-duration is 100 ms.

■ Auto-restart after momentary power failure--**IPF**
(Function code data = 6)

This signal is turned on during the period from when the inverter detects the undervoltage of the DC link bus and stops the output (if auto-restart after recovery of power is selected (F14 = 4 or 5)) until auto-restarting (the output frequency has recovered up to the reference frequency). At that moment of auto-restarting, this signal is turned off.

■ Motor overload early warning--**OL**
(Function code data = 7)

This signal is used to issue a motor overload early warning for enabling you to take corrective action before the inverter detects a motor overload (\overline{OL} alarm) and stops its output.

The motor temperature characteristics are specified by function codes F10 (Electronic thermal overload protection for motor) and F12 (Thermal time constant). If the value calculated from the settings of F10 and F12 exceeds the detection level set by Overload Early Warning/Current Detection/Low Current Detection (Level) (E34), then this signal is turned on. Normally, the recommended set current level for E34 is 80 to 90% of the allowable current set by function code F11 (Overload detection level).

 **Note** Function code E34 is effective for not only the motor overload early warning **OL**, but also for the operation level of the current detection **ID** and low level current detection **IDL**.

■ Auto-resetting--**TRY**
(Function code data = 26)

This signal is turned on when the retry function specified by function codes H04 (Times) and H05 (Reset interval) is activated. Refer to function codes H04 and H05 for details of the output timing and number of retries.

■ Service lifetime alarm--**LIFE**
(Function code data = 30)

This signal is turned on when it is judged that the service life of any of capacitors (DC link bus capacitor and electrolytic capacitor on the printed circuit board) and cooling fan has expired.

This function provides a tentative information for service life of the parts. If this signal is issued, check the service life of these parts in your system according to the maintenance procedure to determine whether the parts should be replaced or not. To maintain stable and reliable operation and avoid unexpected failures, daily and periodic maintenance must be performed.

 For details, refer to Chapter 7, Section 7.2, Table 7.2 "Replacement Parts Judgement with Menu #5 "Maintenance Information" as a Guide."

- Inverter output on--**RUN2**
(Function code data = 35)

This signal is turned on when the motor is driven by the frequency higher than the starting frequency or DC braking is activated.

- Overload prevention control--**OLP**
(Function code data = 36)

This signal is turned on when the overload prevention function is activated if the frequency drop rate comes to be the setting specified by function code H70. The minimum ON-duration is 100 ms.

 For details of the overload prevention control, refer to the descriptions of function code H70.

- Current detected--**ID**
(Function code data = 37)

This signal is turned on when the output current exceeds the operation level set by Overload Early Warning/Current Detection/Low Current Detection (E34: Level) for a duration longer than specified by Current Detection/Low Current Detection (E35: Timer). The minimum ON-duration is 100 ms.

 **Note** Function codes E34 and E35 are used not only to set the current detection **ID**, but also to set the operation level of the motor overload early warning **OL** and low current detection **IDL** and the timer count.

- Low level current detected--**IDL**
(Function code data = 41)

This signal is turned on when the output current drops below the operation level set by Overload Early Warning/Current Detection/Low Current Detection (E34: Level) for a duration longer than specified by Current Detection/Low Current Detection (E35: Timer). The minimum turning-ON time is 100 ms.

 **Note** Function codes E34 and E35 are used not only to set the low current detection **IDL**, but also to set the operation level of the overload early warning **OL** and current detection **ID** and the timer count.

- Alarm output (for any fault)--**ALM**
(Function code data = 99)

This signal is turned on if the protection function is activated so that the inverter enters Alarm mode.

E39	Coefficient for Constant Feeding Rate Time
E50	Coefficient for Speed Indication

This function code sets a coefficient to be used for setting the constant rate of feeding time, load shaft speed or line speed and for displaying its output status.

$$\text{Const. Feeding Rate Time (min)} = \frac{\text{Coeff. for Speed Indication (E50)}}{\text{Freq.} \times \text{Coeff. for Const. Feeding Rate Time (E39)}}$$

$$\text{Load Shaft Speed (r/min)} = (\text{E50: Coeff. for Speed Indication}) \times \text{Frequency (Hz)}$$

$$\text{Line Speed (m/min)} = (\text{E50: Coeff. for Speed Indication}) \times \text{Frequency (Hz)}$$

Where, Freq. is the reference frequency if each expression is for one of the set data for the constant rate of feeding time, load shaft speed, or line speed; it is the output frequency if each expression is for the output status monitor.

Note PID display coefficients A and B (E40 and E41) are the exclusive conversion factors to equate an indicated value with the process command and feedback amount in PID control.

E52	Keypad (Menu display mode)
-----	----------------------------

Allows you to select the display mode on the keypad. For details of the operation of the remote keypad, refer to "Limiting menus to be displayed" in Chapter 3.

This feature is provided to simplify the operation of the keypad. By default E52 is set at 0 (Menu #1: Data setting) at factory shipment. With this setting (E52 = 0), you cannot move to another menu with the \triangle or ∇ key.

Setting of Function Code E52	Menu items you can choose:
0: Function code data editing mode	Menu #1: Data setting
1: Function code data check mode	Menu #2: Data checking
2: Full menu mode	Menu #1 - #6 (#7*)

* Available only when a remote keypad is set up for operation.

Tip If the full-menu mode is selected, pressing the \triangle or ∇ key will cycle through the menu. With the FWD/REV key, you can select the desired menu item. Once the entire menu has been cycled through, the display will return to the first menu item.

Enables or disables timer operation. If it is enabled, entering a run command will run the inverter to drive the motor for the period preset to the timer.

An example of timer operation

- Setting up the timer conditions beforehand
 - Set C21 to 1 to enable timer operation.
 - To have the timer count displayed on the LED monitor at the time of power on, set function code E43 (LED monitor display selection) to "13" (Timer count).
 - Set up the frequency for the timer operation using the built-in potentiometer or the \wedge and \vee keys. If the LED displays the timer count, press the FUNC/DATA key to switch it to the speed monitor and then set the frequency for the timer operation.
- Timer operation (by giving a run command with the RUN key)
 - 1) Use the \wedge or \vee key to set the timer count (in seconds) while monitoring the current count displayed on the LED monitor. Note that the timer count is expressed as integers.
Valid range of Timer Operation time: 1 – 9,999 (sec)
 - 2) Press the RUN key to run the motor, and the timer will start the countdown. The moment the timer finishes the countdown, the inverter stops running the motor even if the STOP key is not pressed. (Timer operation is possible even when the timer count is not displayed on the LED monitor.)
 - 3) After the inverter decelerates the motor to a stop, the timer count on the LED monitor will blink.

Note If timer operation started by the terminal command **FWD** is finished and the inverter decelerates the motor to a stop, then the LED monitor displays $\overline{E}nd$ and the monitor indication (\overline{L} if the timer count is selected) alternately. Turning **FWD** off will switch the LED back to the monitor indication.

P02, P03 Motor Parameters (Rated capacity and Rated current)

Sets the nominal rated capacity that is denoted on the rating nameplate of the motor.

 For FRN4.0C1■-4□**, the default setting for P02 is 3.7.

P09 Motor Parameters (Slip compensation gain)

Sets the gain to compensate for the motor slip frequency. It is based on the typical slip of every inverter model as 100%. Set the compensation gain watching the motor speed.

All the data listed below is applicable to the motors regardless to their output capacity.

Typical rated slip frequencies for 100%

Rated capacity (kW/HP)	Fuji standard 8-series (Hz)	Typical motors rated in HP (Hz)	Fuji standard 6-series (Hz)	Other motors (Hz)
0.06/0.1	1.77	2.50	1.77	1.77
0.1/0.12	1.77	2.50	1.77	1.77
0.2/0.25	2.33	2.50	2.33	2.33
0.4/0.5	2.40	2.50	2.40	2.40
0.75/1	2.33	2.50	2.33	2.33
1.5/2	2.00	2.50	2.00	2.00
2.2/3	1.80	1.17	1.80	1.80
3.7/5	1.93	1.50	1.93	1.93

 For this function which is related with the motor characteristics, the voltage at the base frequency (F05) and motor parameters (P codes) should be also set consistently.





P99 Motor Selection

To use automatic control features (e.g., the auto torque boost/auto energy saving and slip compensation) or overload protection for the motor (electronic thermal), the inverter invokes the parameters and characteristics of the motor. To match the driving characteristics between the inverter and motor, set the motor characteristics with this function code and set H03 to "2" to initialize the motor parameter. This action automatically updates the data of function codes P03, P09 and the constants used inside the inverter.

Motors	P99 =
Fuji standard 8-series (currently standard models)	0
Fuji standard 6-series (conventional models)	3
Other motors or unknown models	4

 • For other motors, the parameters for Fuji 8-series motors are applicable.
• The inverter also supports motors rated by HP (Horse Power: typical in North America, P99 = 1).

Initializes the current function code settings to the factory defaults or initializes the motor constants (parameters).

To change the H03 data, it is necessary to press the  and  keys or the  and  keys simultaneously.

If H03 is set to:	Function
0	Disable initialization (Settings made by the user manually will be retained.)
1	Initialize all function code data to the factory defaults
2	Initialize the P03 data (Rated current of the motor) and internally used constants to the motor constants determined by P02 data (Motor capacity) and P99 (Motor characteristics), as listed on the next page. Initializes P09 data (Slip compensation gain) to 0.0.

-If you do initialization while H03 is set at "1" or "2," H03 will automatically go back to "0" (factory default) at the completion of initialization.

<Procedure for initializing motor constants>

- To initialize the motor constants, set the related function codes as follows.
 - 1) P02 Motor Parameters: Set the rated capacity of the motor to be used in kW.
(Rated capacity)
 - 2) P99 Motor Selection: Select the characteristics of the motor. (Refer to the descriptions given for P99.)
 - 3) H03 Data Initialization: Initialize the motor constants. (H03 = 2)
 - 4) P03 Motor Parameters: Set the rated current printed on the nameplate if the set data differs from the rated current.
(Rated current):
- If any value out of the general motor capacity is set for P02, the capacity will be internally converted to the applicable motor rating (see the table on the next page).

- If P99 (Motor selection) is set to 0 (Fuji standard 8-series motors), 3 (Fuji standard 6-series motors), or 4 (Other motors):

Power supply voltage	Setting range (kW)	Nominal applied motor (kW)	Rated current (A)															
			If P99 (Motor selection) is set to:															
	0			3			4											
	Shipping destination (Version)			Shipping destination (Version)			Shipping destination (Version)											
Function code P02	Asia			EU			Japan			Asia			EU			Japan		
	Three-phase 200 V Single-phase 200 V Single-phase 100 V	0.01 to 0.06	0.06	0.40	0.44	0.38	0.40	0.44	0.38	0.40	0.44	0.38	0.40	0.44	0.38	0.40	0.44	0.38
0.07 to 0.10		0.1	0.62	0.68	0.61	0.62	0.68	0.61	0.62	0.68	0.61	0.62	0.68	0.61	0.62	0.68	0.61	
0.11 to 0.20		0.2	1.18	1.30	1.16	1.19	1.30	1.18	1.18	1.30	1.16	1.18	1.30	1.18	1.30	1.18	1.30	
0.21 to 0.40		0.4	2.10	2.30	2.13	2.10	2.30	2.13	2.10	2.30	2.13	2.10	2.30	2.13	2.10	2.30	2.13	
0.41 to 0.75		0.75	3.29	3.60	3.36	3.29	3.60	3.36	3.29	3.60	3.36	3.29	3.60	3.36	3.29	3.60	3.36	
0.76 to 1.50		1.5	5.55	6.10	5.87	5.55	6.10	5.87	5.55	6.10	5.87	5.55	6.10	5.87	5.55	6.10	5.87	
1.51 to 2.20		2.2	8.39	9.20	8.80	8.39	9.20	8.80	8.39	9.20	8.80	8.39	9.20	8.80	8.39	9.20	8.80	
2.21 to 3.70		3.7	13.67	15.00	14.38	13.67	15.00	14.38	13.67	15.00	14.38	13.67	15.00	14.38	13.67	15.00	14.38	
3.71 to 5.50		5.5	20.04	22.00	21.19	20.04	22.00	21.19	20.04	22.00	21.19	20.04	22.00	21.19	20.04	22.00	21.19	
5.51 to 10.00	7.5	26.41	29.00	28.17	26.41	29.00	28.17	26.41	29.00	28.17	26.41	29.00	28.17	26.41	29.00	28.17		
Three-phase 400 V	0.01 to 0.06	0.06	0.19	0.22	0.19	0.19	0.22	0.19	0.19	0.22	0.19	0.19	0.22	0.19	0.19	0.22	0.19	
	0.07 to 0.10	0.1	0.31	0.34	0.31	0.31	0.34	0.31	0.31	0.34	0.31	0.31	0.34	0.31	0.31	0.34	0.31	
	0.11 to 0.20	0.2	0.58	0.65	0.58	0.59	0.65	0.59	0.58	0.65	0.58	0.58	0.65	0.58	0.65	0.58		
	0.21 to 0.40	0.4	1.09	1.15	1.07	1.09	1.15	1.07	1.09	1.15	1.07	1.09	1.15	1.07	1.09	1.15	1.07	
	0.41 to 0.75	0.75	1.71	1.80	1.68	1.71	1.80	1.68	1.71	1.80	1.68	1.71	1.80	1.68	1.71	1.80	1.68	
	0.76 to 1.50	1.5	3.04	3.05	2.94	3.04	3.05	2.94	3.04	3.05	2.94	3.04	3.05	2.94	3.04	3.05	2.94	
	1.51 to 2.20	2.2	4.54	4.60	4.40	4.54	4.60	4.40	4.54	4.60	4.40	4.54	4.60	4.40	4.54	4.60	4.40	
	2.21 to 3.70	3.7	7.43	7.50	7.20	7.43	7.50	7.20	7.43	7.50	7.20	7.43	7.50	7.20	7.43	7.50	7.20	
	3.71 to 5.50	5.5	10.97	11.00	10.59	10.97	11.00	10.59	10.97	11.00	10.59	10.97	11.00	10.59	10.97	11.00	10.59	
	5.51 to 10.00	7.5	14.63	14.50	14.08	14.63	14.50	14.08	14.63	14.50	14.08	14.63	14.50	14.08	14.63	14.50	14.08	

NOTE: The above values in the "Rated current" column are exclusively applicable to the four-pole Fuji standard motors rated for 200 V or 400 V at 60 Hz. If the base frequency, rated voltage, and the number of poles are different, however, change the P03 data to the rated current printed on the nameplate.

Also when you use non-standard or other manufacturer's motors, change the P03 data to the rated current printed on the motor's nameplate.

■ If P99 (Motor selection) is set to 1 (HP motors):

Power supply voltage	Setting range (HP)	Nominal applied motor (HP)	Rated current (A)		
			If P99 (Motor selection) is set to:		
	1				
	Function code P02		Shipping destination (Version)		
Asia		EU	Japan		
Three-phase 200 V Single-phase 200 V Single-phase 100 V	0.01 to 0.10	0.1	0.44	0.44	0.44
	0.11 to 0.12	0.12	0.68	0.68	0.68
	0.13 to 0.25	0.25	1.40	1.40	1.40
	0.26 to 0.50	0.5	2.00	2.00	2.00
	0.51 to 1.00	1	3.00	3.00	3.00
	1.01 to 2.00	2	5.80	5.80	5.80
	2.01 to 3.00	3	7.90	7.90	7.90
	3.01 to 5.00	5	12.60	12.60	12.60
	5.01 to 7.50	7.5	18.60	18.60	18.60
7.51 to 10.00	10	25.30	25.30	25.30	
Three-phase 400 V	0.01 to 0.10	0.1	0.22	0.22	0.22
	0.11 to 0.12	0.12	0.34	0.34	0.34
	0.13 to 0.25	0.25	0.70	0.70	0.70
	0.26 to 0.50	0.5	1.00	1.00	1.00
	0.51 to 1.00	1	1.50	1.50	1.50
	1.01 to 2.00	2	2.90	2.90	2.90
	2.01 to 3.00	3	4.00	4.00	4.00
	3.01 to 5.00	5	6.30	6.30	6.30
	5.01 to 7.50	7.5	9.30	9.30	9.30
7.51 to 10.00	10	12.70	12.70	12.70	

NOTE: The rated current will be initialized to the value for motors rated for 230 V or 460 V at 60 Hz. If the base frequency or rated voltage is different, change the P03 data to the rated current printed on the nameplate.

To automatically exit from the alarm status and restart the inverter, use the retry functions. The inverter automatically exits from Alarm mode and restarts without issuing a block alarm even if it has entered the forced Alarm mode. If the inverter has entered Alarm mode many times in excess of the number of times specified by function code H04, it issues a block alarm and does not exit Alarm mode for re-starting.

Listed below are the recoverable alarm statuses of the inverter.

Alarm status	LED monitor display	Alarm status	LED monitor display
Overcurrent protection	<i>OC 1, OC2 or OC3</i>	Braking resistor overheated	<i>obH</i>
Overvoltage protection	<i>OU 1, OU2 or OU3</i>	Motor overloaded	<i>OL 1</i>
Heat sink overheated	<i>OH 1</i>	Inverter overloaded	<i>OLU</i>
Motor overheated	<i>OH4</i>		

■ Number of reset times (H04)

Set the number of reset times for automatic exit from Alarm mode. If the inverter has entered Alarm mode during the retry times specified, the inverter issues a block alarm and will not exit from Alarm mode for restarting.

⚠ WARNING

If the "auto-reset" function has been specified, the inverter may automatically restart and run the motor stopped due to a trip fault, depending on the cause of the tripping. Design the machinery so that human body and peripheral equipment safety is ensured even when the auto-resetting succeeds.

Otherwise an accident could occur.

■ Reset interval (H05)

Sets the latency time for automatic exit from Alarm mode. Refer to the timing scheme diagram below.

Operation timing chart

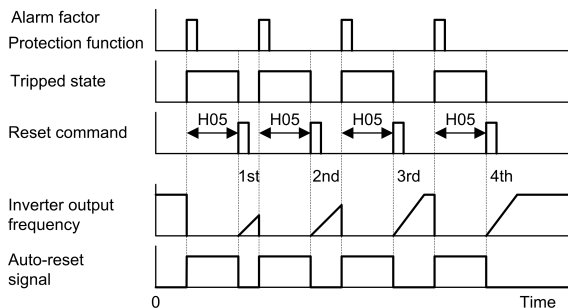

Specifies the acceleration and deceleration patterns (output frequency patterns).

Linear acceleration/deceleration

The inverter runs the motor with the constant acceleration and deceleration.

S-curve acceleration/deceleration

To reduce the impact on the inverter-driven motor during acceleration/deceleration, the inverter gradually accelerates/decelerates the motor in both the acceleration/deceleration zones.

Curvilinear acceleration/deceleration

The inverter drives the motor to output maximum performance with a constant loading rate as follows:

- In the zone under the base frequency, linear acceleration/deceleration of constant torque output for the motor
- In the zone above the base frequency, speed two times the base frequency and acceleration/deceleration half of the base frequency

Selects whether the inverter will perform current limiting processing or cause an overcurrent trip if the output current exceeds the instantaneous overcurrent limit level.

If the instantaneous overcurrent limiting is enabled, the inverter will immediately turn off its output gates to suppress the increase of current and control the output frequency.

If current limiting processing makes the motor decrease its torque temporarily so as to cause any problem, then disable overcurrent limiting to cause an overcurrent trip and apply brake to the motor.

 **Note** The same functions to limit the output current are implemented by software as function codes F43 and F44. Generally, software features have an operation delay, so enable function code H12 as well.

Depending upon the load, acceleration in an extremely short period may activate the current limiter to suppress the increase of the inverter output frequency, causing the system oscillate (hunting) or making the inverter enter the  Alarm mode and trip. When setting the acceleration time, therefore, you need to take into account the load condition and moment of inertia. Refer to the FRENIC-Mini User's Manual (MEH446), Chapter 7, Section 7.1, "Selecting Motors and Inverters."

The moment a regenerative energy exceeding the braking capacity of inverter is returned during deceleration, the inverter will stop its output and enter overvoltage Alarm mode. If regenerative energy suppressing control is enabled, the inverter lengthens the deceleration time to 3 times the preset time and decreases the deceleration torque to 1/3 when the DC link bus voltage exceeds the preset voltage suppressing level. In this way, the inverter makes the motor reduce the regenerative energy tentatively.

Note This control is used to suppress the torque generated by the motor in deceleration. Conversely, when the load on the motor results in a braking effect, the control does not have any effect, so do not use it in this case.

Disable this control when the inverter features a braking resistor. If it is enabled, the braking resistor and regenerative energy suppressing control may conflict with each other, which may change the deceleration time unexpectedly.

Enables or disables the overload suppressing control. If enabled, this function code is used to set the deceleration (Hz/s).

Before the inverter enters Alarm mode due to the heat sink overheat or overload (alarm code: *OH1* or *OL1*), this control decreases the output frequency of the inverter to suppress the trip.

Apply this control to equipment (such as pumps) whose drive frequency drops in line with any decrease in load. If you want to proceed to drive such kind of equipment even the inverter slows down the output frequency, enable this control.

Note Do not use this control to equipment whose load does not slow if the inverter output frequency drops, as it will have no effect.

If the following functions to limit the output current are enabled ($F43 \neq 0$ and $H12 = 1$), this control does not work.

The inverter can be operated using a functional combination of "Priority on STOP Key" and "Start Check."

■ STOP key priority

Pressing the  key on the keypad forces the inverter to decelerate and stop the motor even if the inverter is running by any run commands given via the terminals or communications (link operation). After the motor stops, the inverter issues alarm *Er6*.



■ Start check function

The inverter prohibits any run commands to be executed and displays $E-6$ on the LED of keypad when:

- The power is first applied.
- The  key is pressed or the **RST** signal is turned on to cancel the alarm.
- Link command **LE** has switched inverter operations.

H97 Clear Alarm Data

Deletes the alarm information that has been accumulated in the internal memory of the inverter.

To delete the alarm data, set H97 to "1" by simultaneously holding down the  and  keys, and then press the  key.

H98 Protection/Maintenance Function

Specifies a combination between automatic lowering of carrier frequency, output phase loss protection, input phase loss protection.

Automatic DEC function for carrier frequency

Select this feature to protect the system from any failure which could result from the inverter tripping due to the heat sink overheating (CH), or overload (OL), abnormally high ambient temperature or a cooling mechanism failure. This feature lowers the output frequency before the inverter enters Alarm mode. However, the level of motor noise may increase.

Input phase loss protection (IPL)

If a phase loss is detected in the three-phase input power source, the inverter will enter Alarm mode and issue an alarm (IPL). This prevents the inverter from undergoing heavy stress that may be caused by input phase loss or interphase voltage unbalance exceeding 6%.

 **Note** If connected load is light or a DC reactor is connected to the inverter, this function will not detect input phase loss if any.

For inverters with single-phase input, this protection does not take effect. Do not enable it. When you single-phase an inverter designed for a three-phase input for the testing purposes, you may disable this protection only if you can reduce its load.

Output phase loss protection (OPL)

The inverter will enter the alarm mode activated by the output phase loss protection, and issue the alarm OPL if it detects an output phase loss while it is running.

Chapter 6 TROUBLESHOOTING

6.1 Before Proceeding with Troubleshooting

WARNING

If any of the protective functions have been activated, first remove the cause. Then, after checking that the all run commands are set to off, reset the alarm. Note that if the alarm is reset while any run commands are set to on, the inverter may supply the power to the motor which may cause the motor to rotate.

Injury may occur.

- Even though the inverter has interrupted power to the motor, if the voltage is applied to the main circuit power input terminals L1/R, L2/S and L3/T (L1/L and L2/N for single-phase voltage input), voltage may be output to inverter output terminals U, V, and W.
- Some electric charge may remain in the DC link bus capacitor even after the power is turned off. Therefore, it may take some time until the DC link bus voltage reaches a safe level. Before touching the circuit, wait for at least five minutes after the power has been turned off and check that the DC voltage between main circuit terminals P (+) and N (-) is less than +25 VDC using a multimeter.

Electric shock may occur.

Follow the procedure below to solve problems.

- (1) First, check that the inverter is correctly wired, referring to Chapter 2, Section 2.3.5 "Wiring for Main Circuit Terminals and Grounding Terminals."
- (2) Check whether an alarm code is displayed on the LED monitor.

If no alarm code appears on the LED monitor

— Motor is running abnormally	➔ Go to Section 6.2.1.
— Problems with inverter settings	➔ Go to Section 6.2.2.

If an alarm code appears on the LED monitor ➔ Go to Section 6.3.

If an abnormal pattern appears on the LED monitor while no alarm code is displayed ➔ Go to Section 6.4.

If any problems persist after the above recovery procedure, contact your Fuji Electric representative.

■ Quick reference table of alarm codes

Alarm code	Name	Refer to	Alarm code	Name	Refer to
<i>OL1</i>	Overcurrent protection	p.6-9	<i>OH4</i>	PTC thermistor for motor protection	p.6-13
<i>OL2</i>			<i>OH1</i>	Overheat protection for braking resistor	p.6-14
<i>OL3</i>			<i>OL1</i>	Electronic thermal overload relay	p.6-14
<i>OU1</i>	Overvoltage protection	p.6-10	<i>OUU</i>	Overload protection	p.6-15
<i>OU2</i>			<i>Er1</i>	Memory error	p.6-15
<i>OU3</i>			<i>Er2</i>	Remote keypad communications error	p.6-16
<i>LU</i>	Undervoltage protection	p.6-10	<i>Er3</i>	CPU error	p.6-16
<i>L in</i>	Input phase loss protection	p.6-11	<i>Er6</i>	Operation protection	p.6-17
<i>OPL</i>	Output phase loss protection	p.6-12	<i>Er8</i>	RS-485 communications error	p.6-17
<i>OH1</i>	Overheat protection for heat sink	p.6-12	<i>ErF</i>	Data save error during undervoltage	p.6-18
<i>OH2</i>	External alarm input	p.6-13			

(Note) An under bar (_ _ _ _) will be displayed when an undervoltage condition is detected and a run command is present while the setting of F14 (Restart mode after momentary power failure (function selection)) is not "0."

6.2 If No Alarm Code Appears on the LED Monitor

6.2.1 Motor is running abnormally

[1] The motor does not rotate.

Possible Causes	What to Check and Suggested Measures
(1) No power supplied to the inverter.	<p>Check the input voltage, output voltage and interphase voltage unbalance.</p> <ul style="list-style-type: none">➔ Turn on a molded case circuit breaker, an earth leakage circuit breaker (with overcurrent protection) or a magnetic contactor.➔ Check for voltage drop, phase loss, poor connections, or poor contacts, and fix them if necessary.
(2) No forward/reverse operation command was inputted, or both the commands were inputted simultaneously (external signal operation).	<p>Check the input status of the forward/reverse command with Menu #4 "I/O checking" using the keypad.</p> <ul style="list-style-type: none">➔ Input a run command.➔ Set either the forward or reverse operation command to off if both commands are being inputted.➔ Correct the assignment of commands <i>FWD</i> and <i>REV</i> to function codes E98 and E99.➔ Connect the external circuit wires to control circuit terminals [FWD] and [REV] correctly.
(3) No indication of rotation direction (keypad operation).	<p>Check the input status of the forward/reverse rotation direction command with Menu #4 "I/O checking" using the keypad.</p> <ul style="list-style-type: none">➔ Input the rotation direction (F02 = 0), or select the keypad operation with which the rotation direction is fixed (F02 = 2 or 3).
(4) The inverter could not accept any run commands from the keypad since it was in Programming mode.	<p>Check which operation mode the inverter is in, using the keypad.</p> <ul style="list-style-type: none">➔ Shift the operation mode to Running mode and enter a run command.
(5) A run command with higher priority than the one attempted was active, and the run command was stopped.	<p>While referring to the block diagram of the drive command generator*, check the higher priority run command with Menu #2 "Data checking" and Menu #4 "I/O checking" using the keypad.</p> <p>*Refer to the FRENIC-Mini User's Manual (MEH446), Chapter 4.</p> <ul style="list-style-type: none">➔ Correct any incorrect function code data settings (e.g., cancel the higher priority run command).
(6) The reference frequency was set below the starting or stop frequency.	<p>Check that a frequency command has been entered, with Menu #4 "I/O checking" using the keypad.</p> <ul style="list-style-type: none">➔ Set the value of the frequency command to the same or higher than that of the starting or stop frequency (F23 or F25).➔ Reconsider the starting and stop frequencies (F23 and F25), and if necessary, change them to lower values.➔ Inspect the frequency command devices, signal converters, switches, or relay contacts. Replace any ones that are faulty.➔ Connect the external circuit wires correctly to terminals [13], [12], [11] and [C1].

Possible Causes	What to Check and Suggested Measures
(7) A frequency command with higher priority than the one attempted was active.	<p>Check the higher priority run command with Menu #2 "Data checking" and Menu #4 "I/O checking" using the keypad, referring to the block diagram of the drive command generator.</p> <p>*Refer the FRENIC-Mini User's Manual (MEH446), Chapter 4.</p> <p>→ Correct any incorrect function code data settings (e.g. cancel the higher priority run command).</p>
(8) The peak and bottom frequencies for the frequency limiters were set incorrectly.	<p>Check the data of function codes F15 (frequency limiter (high)) and F16 (frequency limiter (low)).</p> <p>→ Change the settings of F15 and F16 to the correct ones.</p>
(9) The coast-to-stop command was effective.	<p>Check the data of function codes E01, E02, E03, E98 and E99 and the input signal status with Menu #4 "I/O checking" using the keypad.</p> <p>→ Release the coast-to-stop command setting.</p>
(10) Broken wire, incorrect connection or poor contact with the motor.	<p>Check the cabling and wiring (Measure the output current).</p> <p>→ Repair the wires to the motor, or replace them.</p>
(11) Overload	<p>Measure the output current.</p> <p>→ Lighten the load.</p>
	<p>Check that a mechanical brake is in effect.</p> <p>→ Release the mechanical brake, if any.</p>
(12) Torque generated by the motor was insufficient.	<p>Check that the motor starts running if the value of torque boost (F09) is increased.</p> <p>→ Increase the value of torque boost (F09) and try to run the motor.</p>
	<p>Check the data of function codes F04, F05, H50, and H51.</p> <p>→ Change the V/f pattern to match the motor's characteristics.</p>

[2] The motor rotates, but the speed does not increase.

Possible Causes	What to Check and Suggested Measures
(1) The maximum frequency currently specified was too low.	<p>Check the data of function code F03 (Maximum frequency).</p> <p>→ Readjust the data of the maximum frequency (F03).</p>
(2) The data of frequency limiter currently specified was too low.	<p>Check the data of function code F15 (Frequency limiter (high)).</p> <p>→ Readjust the setting of F15.</p>
(3) The reference frequency currently specified was too low.	<p>Check the signals for the frequency command from the control circuit terminals with Menu #4 "I/O checking" using the keypad.</p> <p>→ Increase the frequency of the command.</p> <p>→ If an external potentiometer for frequency command, signal converter, switches, or relay contacts are malfunctioning, replace them.</p> <p>→ Connect the external circuit wires to terminals [13], [12], [11], and [C1] correctly.</p>

Possible Causes	What to Check and Suggested Measures
(4) A frequency command with higher priority than the one attempted (e.g., multi-frequency, communications or jogging operation, etc.) was active and the reference frequency was set to too low a value.	<p>Check the settings (data) of the relevant function codes and what frequency commands are being received, through Menu #1 "Data setting," Menu #2 "Data checking" and Menu #4 "I/O checking," using the remote keypad and referring to the block diagram of the frequency setting circuit.</p> <p>*Refer to the FRENIC-Mini User's Manual (MEH446), Chapter 4.</p> <p>→ Correct any incorrect function code data settings (e.g. cancel higher priority run commands, etc.).</p>
(5) The acceleration/ deceleration time was too long.	<p>Check the data of function codes F07, F08, E10, E11 and H54.</p> <p>→ Change the acceleration/deceleration time to match the load.</p>
(6) Overload	<p>Measure the output current.</p> <p>→ Lighten the load (e.g., operate the mechanical brake correctly).</p> <p>Check if mechanical brake is working.</p> <p>→ Release the mechanical brake.</p>
(7) The current limiting operation did not increase the output frequency.	<p>Make sure that F43 (Current limiter (mode selection)) is set to "2" and check the setting of F44 (Current limiter (level)).</p> <p>→ Readjust the setting of F44, or disable the function of current limiting in F43.</p>
	<p>Decrease the value of torque boost (F09), then turn the power off and back on again and check if the speed increases.</p> <p>→ Adjust the value of the torque boost (F09).</p>
	<p>Check the data of function codes F04, F05, H50, and H51 to ensure that the V/f pattern is right.</p> <p>→ Match the V/f pattern values with the motor ratings.</p>
(8) Bias and gain set incorrectly.	<p>Check the data of function codes F18, C50, C32, C34, C37 and C39.</p> <p>→ Readjust the bias and gain to appropriate values.</p>

[3] The motor runs in the opposite direction to the command.

Possible Causes	What to Check and Suggested Measures
(1) Wiring has been connected to the motor incorrectly	<p>Check the wiring to the motor.</p> <p>→ Connect terminals U, V, and W of the inverter to the respective U, V, and W terminals of the motor.</p>
(2) Incorrect connection and settings for run commands and rotation direction command FWD and REV	<p>Check the data of function codes E98 and E99 and the connection to terminals [FWD] and [REV].</p> <p>→ Correct the data of the function codes and the connection.</p>
(3) The setting for the rotation direction via keypad operation is incorrect.	<p>Check the data of function code F02 (Operation method).</p> <p>→ Change the data of function code F02 to 2 (forward rotation) or 3 (reverse rotation).</p>

[4] If the speed variation and current vibration (such as hunting) occur at the constant speed

Possible Causes	What to Check and Suggested Measures
(1) The frequency command fluctuated.	Check the signals for the frequency command with Menu #4 "I/O checking" using the keypad. → Increase the filter constants (C33 and C38) for the frequency command.
(2) The external frequency command device was used.	Check that there is no noise in the control signal wires from external sources. → Isolate the control signal wires from the main circuit wires as far as possible. → Use shielded or twisted wires for the control signal.
(3) The slip compensation gain was too large.	Check that the motor vibration is absorbed if the slip compensation (P09) is cancelled. → Readjust the slip compensation value (P09) or deactivate slip compensation altogether.
(4) The vibration system having low stiffness in a load caused hunting or the current is irregular due to special motor constants.	Cancel the automatic control system (automatic torque boost, slip compensation, energy saving operation, overload prevention control, current limiting) and check that the motor vibration is suppressed (F37, P09, H70, and F43). → Cancel the functions causing the vibration. → Readjust the data of the oscillation suppression gain (H80) currently set to appropriate values.
	Check that the motor vibration is suppressed if you decrease the level of the motor sound (carrier frequency) (F26) or set the motor sound (tone) to "0" (F27 = 0). → Decrease the carrier frequency (F26) or set the sound tone to "0" (F27 = 0).

[5] If grating sound can be heard from motor

Possible Causes	What to Check and Suggested Measures
(1) The carrier frequency was set too low.	Check the data of function codes F26 (Motor sound (carrier frequency)) and F27 (Motor sound (tone)). → Increase the carrier frequency (F26). → Readjust the setting of F27 to appropriate value.

[6] The motor does not accelerate and decelerate at the set time.

Possible Causes	What to Check and Suggested Measures
(1) The inverter ran the motor by S-curve or curvilinear pattern.	Check the data of function code H07 (Acceleration/ deceleration pattern). → Select the linear pattern (H07 = 0).
(2) The current limiting prevented the output frequency from increasing.	Make sure that F43 (Current limiter (mode selection)) is set to "2", and check that the setting of F44 (Current limiter (level)) is reasonable. → Readjust the setting of F44 to appropriate value, or disable the function of current limiting in F43. → Increase the acceleration/deceleration time (F07, F08, E10, and E11).

Possible Causes	What to Check and Suggested Measures
(3) The automatic deceleration was active.	<p>Check the data of function code H69 (Automatic deceleration (mode selection)).</p> <p>→ Consider the use of a braking resistor.</p> <p>→ Increase the deceleration time (F08 and E11).</p>
(4) Overload	<p>Measure the output current.</p> <p>→ Lighten the load.</p>
(5) Torque generated by the motor was insufficient.	<p>Check that the motor starts running if the value of the torque boost (F09) is increased.</p> <p>→ Increase the value of the torque boost (F09).</p>
(6) An external frequency command device is being used.	<p>Check that there is no noise in the external signal wires.</p> <p>→ Isolate the control signal wires from the main circuit wires as far as possible.</p> <p>→ Use shielded wire or twisted wire for the control signal wires.</p>

[7] Even if the power recovers after a momentary power failure, the motor does not restart.

Possible Causes	What to Check and Suggested Measures
(1) The setting of function code F14 is either 0 or 1.	<p>Check if an undervoltage trip occurs.</p> <p>→ Change the data of function code F14 (Restart mode after momentary power failure (mode selection)) to 4 or 5.</p>
(2) The run command stayed off even after power has been restored.	<p>Check the input signal with Menu #4 "I/O checking" using the keypad.</p> <p>→ Check the power recovery sequence with an external circuit. If necessary, consider the use of a relay that can keep the run command on.</p>

[8] The inverter does not run as expected

Possible Causes	What to Check and Suggested Measures
(1) Wrong configuration of function codes	<p>Check that all function codes are correctly configured.</p> <p>→ Correct the configuration of the function codes.</p>
	<p>Make a note of function code data currently configured and initialize all function code data (H03).</p> <p>→ After initialization, reconfigure the necessary function codes one by one, checking the running status of the inverter.</p>

6.2.2 Problems with inverter settings

[1] Data of function codes cannot be changed

Possible Causes	What to Check and Suggested Measures
(1) An attempt was made to change function code data that cannot be changed when the inverter is running.	Check if the inverter is running with Menu #3 "Drive monitoring" using the keypad and then confirm whether the data of the function codes can be changed when the motor is running by referring to the function code tables. → Stop the motor then change the data of the function codes.
(2) The data of the function codes is protected.	Check the data of function code F00 (Data protection). → Change the setting of F00 from "1" to "0."
(3) The WE-KP command ("Enable editing of function codes data from keypad") is not input though it has been assigned to a digital input terminal.	Check the data of function codes E01, E02, E03, E98 and E99 and the input signals with Menu #4 "I/O checking" using the keypad. → Change the setting of F00 from "1" to "0," or input a WE-KP command through a digital input terminal.
(4) DC link bus voltage was below the undervoltage detection level.	Check the DC link bus voltage with Menu #5 "Maintenance information" and measure the input voltage using the keypad. → Connect the inverter to a power supply that matches its input rating.

[2] The desired menu is not displayed.

Causes	Check and Measures
(1) The limiting menus function was not selected appropriately.	Check the data of function code E52 (Menu display mode). → Change the data of function code E52 so that the desired menu can be displayed.

[3] Nothing appears on the LED monitor.

Possible Causes	What to Check and Suggested Measures
(1) No power supplied to the inverter.	Check the input voltage, output voltage and interphase voltage unbalance. → Connect a molded case circuit breaker, an earth leakage circuit breaker (with overcurrent protection) or a magnetic contactor. → Check for voltage drop, phase loss, poor connections, or poor contacts, and fix them if necessary.
(2) The power for the control circuit did not reach a high enough level.	Check if the jumper bar has been removed between terminals P1 and P (+) or if there is poor contact between the jumper bar and the terminals. → Connect the jumper bar to terminals P1 and P (+) or tighten the screws. Or connect a DC reactor. → Replace the inverter if it is malfunctioning.

6.3 If an Alarm Code Appears on the LED Monitor

[1] *OCn* Overcurrent protection

Problem The inverter output current momentarily exceeded the overcurrent level.

OC1 Overcurrent occurred during acceleration.

OC2 Overcurrent occurred during deceleration.

OC3 Overcurrent occurred when running at a constant speed.

Possible Causes	What to Check and Suggested Measures
(1) The inverter output terminals were short-circuited.	<p>Remove the wires connected to the inverter output terminals (U, V, and W) and measure the interphase resistance. Check if the resistance is too low.</p> <p>→ Remove the part that short-circuited (including replacement of the wires, relay terminals and motor).</p>
(2) Ground faults occurred at the inverter output terminals.	<p>Remove the wires connected to the inverter output terminals (U, V, and W) and perform a Megger test.</p> <p>→ Remove the part that short-circuited (including replacement of the wires, relay terminals and motor).</p>
(3) Loads were too heavy.	<p>Measure the motor current with a measuring device, and to trace the current trend. Therefore, use this information to judge if the trend is over the calculated load value for your system design.</p> <p>→ If the load is too heavy, decrease it or raise the inverter capacity.</p> <p>Trace the current trend and check if there are any sudden changes in the current.</p> <p>→ If there are any sudden changes, make the load variation smaller or raise the inverter capacity.</p> <p>→ Enable instantaneous overcurrent limiting (H12 = 1).</p>
(4) The value set for torque boost (F09) was too large. (F37 = 0, 1, 3, or 4)	<p>Check that the output current decreases and the motor does not come to stall if you set a lower value than the current one for F09.</p> <p>→ Lower the value for torque boost (F09) if the motor is not going to stall.</p>
(5) The acceleration/ deceleration time was too short.	<p>Check that the motor generates enough torque required during acceleration/deceleration. That torque is calculated from the moment of inertia for the load and the acceleration/ deceleration time.</p> <p>→ Increase the acceleration/deceleration time (F07, F08, E10, E11, and H54).</p> <p>→ Enable current limiting (F43).</p> <p>→ Raise the inverter capacity.</p>
(6) Malfunction caused by noise	<p>Check if noise control measures are appropriate (e.g., correct grounding and routing of control and main circuit wires).</p> <p>→ Implement noise control measures. For details, refer to "Appendix A" of the FRENIC-Mini User's Manual (MEH446).</p> <p>→ Enable the retry function (H04).</p>

[2] *OU*h Overvoltage protection

Problem The DC link bus voltage was over the detection level of overvoltage.

OU1 Overvoltage occurs during the acceleration.

OU2 Overvoltage occurs during the deceleration.

OU3 Overvoltage occurs during running at constant speed.

Possible Causes	What to Check and Suggested Measures
(1) The power supply voltage was over the range of the inverter's specifications.	Measure the input voltage. → Decrease the voltage to within that of the specifications.
(2) The acceleration time was too short.	Check if the overvoltage alarm occurs after sudden acceleration. → Increase the acceleration time (F07, E10, and H54). → Select the S-curve pattern (H07). → Consider the use of a braking resistor.
(3) The deceleration time was too short for the moment of inertia for load.	Recalculate the deceleration torque from the moment of inertia for load and the deceleration time. → Increase the deceleration time (F08, E11, and H54). → Enable automatic deceleration (H69=1) so that when the DC link bus voltage exceeds the overvoltage suppression level, the inverter changes the deceleration time to three times longer than the set value. → Set the rated voltage (at base frequency) (F05) to 0 to improve braking ability. → Consider the use of a braking resistor.
(4) Loads were suddenly removed.	- Check if the alarm occurs when loads are suddenly removed. - Check if the inverter operation suddenly changes from driving operation to braking operation. → Consider the use of a braking resistor.
(5) Braking load was too heavy.	Compare the braking torque of the load with that of the inverter. → Set the rated voltage (at base frequency) (F05) to 0 to improve braking ability. → Consider the use of a braking resistor.
(6) Malfunction caused by noise.	Check if the DC link bus voltage was below the protective level when the alarm occurred. → Improve noise control. For details, refer to "Appendix A" of the FRENIC-Mini User's Manual (MEH446). → Enable the retry function (H04).

[3] *LU* Undervoltage protection

Problem DC link bus voltage was below the undervoltage detection level.

Possible Causes	What to Check and Suggested Measures
(1) A momentary power failure occurred.	→ Reset the alarm. → If you want to restart running the motor by not treating this condition as an alarm, set F14 to "4" or "5," depending on the load.

Possible Causes	What to Check and Suggested Measures
(2) The power to the inverter was switched back on too soon (with F14 = 1)	Check with LED monitor if the power to the inverter was switched back on although its control circuit was still operating. → Make the interval longer for re-power on.
(3) The power supply voltage did not reach the range of the inverter's specifications.	Measure the input voltage. → Increase the voltage to within that of the specifications.
(4) Peripheral equipment for the power circuit malfunctioned, or the connection was incorrect.	Measure the input voltage to find where the peripheral equipment malfunctioned or which connection is incorrect. → Replace any faulty peripheral equipment, or correct any incorrect connections.
(5) Other loads were connected to the same power system and required a large current to start running to the extent that it caused a temporary voltage drop on the supply side.	Measure the input voltage and check the voltage variation. → Reconsider the power system configuration.
(6) Inverter's inrush current caused the power voltage drop because power transformer capacity was insufficient.	Check if the alarm occurs when you switch on a molded case circuit breaker, an earth leakage circuit breaker (with overcurrent protection) or a magnetic contactor. → Reconsider the capacity of the power transformer.

[4] \angle Input phase loss protection

Problem Input phase loss occurred, or interphase voltage unbalance rate was large.

Possible Causes	What to Check and Suggested Measures
(1) Main circuit power input wires broken.	Measure the input voltage. → Repair or replace the wires.
(2) The terminal screws for the main circuit power input of the inverter were not tight enough.	Check if the screws on the inverter input terminals have become loose. → Tighten the terminal screws to the recommended torque.
(3) Interphase unbalance rate of three-phase voltage was too large.	Measure the input voltage. → Connect an AC reactor (ACR) or a DC reactor (DCR) to lower the rate. → Raise the inverter capacity.
(4) Overload cyclically occurred.	Measure ripple wave of DC link bus voltage. → If the ripple is large, raise the inverter capacity
(5) Single-phase voltage was inputted to the inverter instead of three-phase voltage input.	Check the inverter type. → Obtain a new inverter that meets the power supply specifications.

[5] *OPL* Output phase loss protection

Problem Output phase loss occurred.

Possible Causes	What to Check and Suggested Measures
(1) Inverter output wires are broken	Measure the output current. → Replace the output wires.
(2) Wire for motor winding are broken	Measure the output current. → Replace the motor.
(3) The terminal screws for inverter output were not tight enough.	Check if any screw on the inverter output terminals has become loose. → Tighten the terminal screws to the recommended torque.
(4) A single-phase motor has been connected	→ Single-phase motors cannot be used. Note that the FRENIC-Mini only drives three-phase induction motors.

[6] *OHI* Overheat protection for heat sink

Problem Temperature around heat sink rose.

Possible Causes	What to Check and Suggested Measures
(1) Temperature around the inverter exceeded that of inverter specifications.	Measure the temperature around the inverter. → Lower the temperature around the inverter (e.g., ventilate the panel well). → Lighten the load.
(2) Accumulated running time of the cooling fan exceeded the standard period for replacement, or the cooling fan malfunctioned.	Check the cumulative running time of the cooling fan. Refer to Chapter 3, Section 3.2.2 [5], "Reading Maintenance Information." → Replace the cooling fan.
	Visually check that the cooling fan rotates normally. → Replace the cooling fan.
(3) Air vent is blocked.	Check if there is sufficient clearance around the inverter. → Increase the clearance.
	Check if the heat sink is not clogged. → Clean the heat sink.
(4) Load was too heavy.	Measure the output current. → Lighten the load (e.g. lighten the load before the overload protection occurs using the overload early warning (E34). → Decrease the motor sound (carrier frequency) (F26). → Enable the overload protection control (H70).

[7] *042* External alarm input

Problem External alarm was inputted (THR).

Possible Causes	What to Check and Suggested Measures
(1) An alarm function of the external equipment was activated.	Inspect external equipment operation. → Remove the cause of the alarm that occurred.
(2) Connection has been performed incorrectly.	Check if the wire for the external alarm signal is correctly connected to the terminal to which the "Alarm from external equipment" has been assigned. → Connect the wire for the alarm signal correctly.
(3) Incorrect settings.	Check if the "Alarm from external equipment" has not been assigned to an unassigned terminal. → Correct the assignment.

[8] *044* PTC thermistor for motor protection

Problem Temperature of the motor rose abnormally.

Possible Causes	What to Check and Suggested Measures
(1) Temperature around the motor exceeded that of motor specifications.	Measure the temperature around the motor. → Decrease the temperature. → Lighten the load.
(2) Cooling system for the motor malfunctioned.	Check if the cooling system of the motor is operating normally. → Repair or replace the cooling system of the motor.
(3) Load was too heavy.	Measure the output current. → Lighten the load (e.g., lighten the load before overload occurs using the overload early warning (E34) function). → Decrease the temperature around the motor. → Increase the motor sound (carrier frequency) (F26).
(4) The set activation level (H27) of the PTC thermistor for motor overheat protection was inadequate.	Check the thermistor specifications and recalculate the detection voltage. → Reconsider the data of function code H27.
(5) A PTC thermistor and pull-up resistor were connected incorrectly or the resistance was inadequate.	Check the connection and the resistance of the pull-up resistor. → Correct the connections and replace the resistor with one with an appropriate resistance.
(6) The value set for the torque boost (F09) was too high.	Check the data of function code F09 and readjust the data so that the motor does not stall even if you set the data to a lower value. → Readjust the data of the function code F09.
(7) The V/f pattern did not match the motor.	Check if the base frequency (F04) and rated voltage at base frequency (F05) match the values on the nameplate on the motor. → Match the function code data to the values on the nameplate of the motor.

[9] *dbH* Overheat protection for braking resistor

Problem Thermal protection for braking resistor activated.

Possible Causes	What to Check and Suggested Measures
(1) Braking load was too heavy.	Recalculate the relation between the braking load and braking capacity. → Lighten the braking load. → Reconsider the choice of the braking resistor in order to improve braking ability. Resetting the data of function codes F50 and F51 is also required.
(2) The deceleration time was too short.	Recalculate the required deceleration torque and time from the moment of inertia for the load and the deceleration time. → Increase the deceleration time (F08, E11, and H54). → Reconsider the choice of the braking resistor in order to improve the braking ability. Resetting the data of function codes F50 and F51 is also required.
(3) Incorrect values have been set for the data of function codes F50 and F51.	Check the braking resistor specifications. → Reconsider and change the data of function codes F50 and F51.

Note: The inverter does not detect the overheating alarm of a braking resistor by monitoring its surface temperature, but by monitoring its load magnitude.

Therefore, even if the surface temperature itself does not rise, the alarm may be detected if the resistor is used more frequently than the set data of function codes F50 and F51. If you use the resistor to the limit of its capacity, you must adjust the data of function codes F50 and F51 while checking the surface temperature of the resistor.

[10] *OL* / Electronic thermal overload relay

Problem Electronic thermal function for motor overload detection was activated.

Possible Causes	What to Check and Suggested Measures
(1) Load was too heavy.	Measure the output current. → Lighten the load (e.g., lighten the load before overload occurs using the overload early warning (E34)).
(2) The acceleration/ deceleration time was too short.	Check that the motor generates enough torque for acceleration/deceleration. This torque is calculated from the moment of inertia for the load and the acceleration/ deceleration time. → Increase the acceleration/ deceleration time (F07, F08, E10, E11 and H54).
(3) The characteristics of electronic thermal did not match those of the motor overload.	Check the motor characteristics. → Reconsider the data of function codes P99, F10 and F12. → Use an external thermal relay.
(4) Activation level for the electronic thermal relay was inadequate.	Check the continuous allowable current of the motor. → Reconsider and change the data of function code F11.

[11] *OLU* Overload protection

Problem Temperature inside inverter rose abnormally.

Possible Causes	What to Check and Suggested Measures
(1) Temperature around the inverter exceeded that of inverter specifications.	Measure the temperature around the inverter. → Lower the temperature (e.g., ventilate the panel well). → Lighten the load.
(2) The service life of the cooling fan has expired or the cooling fan malfunctioned.	Check the cumulative running time of cooling fan. Refer to Chapter 3, Section 3.2.2 [5], "Reading Maintenance Information." → Replace the cooling fan.
	Visually check that the cooling fan rotates normally. → Replace the cooling fan.
(3) Air vent is blocked.	Check if there is sufficient clearance around the inverter. → Increase the clearance.
	Check if the heat sink is not clogged. → Clean the heat sink.
(4) Load was too heavy.	Measure the output current. → Lighten the load (e.g., lighten the load before overload occurs using the overload early warning (E34)). → Decrease the motor speed (carrier frequency) (F26). → Enable overload prevention control (H70).
(5) The acceleration/ deceleration time was too short.	Recalculate the required acceleration/deceleration torque and time from the moment of inertia for the load and the deceleration time. → Increase the acceleration/deceleration time (F07, F08, E10, E11 and H54).
(6) The wires to the motor are too long and caused a large amount of current to leak from them.	Measure the leak current. → Insert an output circuit filter (OFL).

[12] *Er* / Memory error

Problem Error occurred in writing the data to the memory in the inverter.

Possible Causes	What to Check and Suggested Measures
(1) While the inverter was writing data (especially initializing data), power supply was turned off and the voltage for the control circuit dropped.	Check if pressing the  key resets the alarm after the function code data are initialized by setting the data of H03 to 1. → Return the initialized function code data to their previous settings, then restart the operation.

Possible Causes	What to Check and Suggested Measures
(2) A high intensity noise was given to the inverter while data (especially initializing data) was being written.	Check if appropriate noise control measures have been implemented (e.g., correct grounding and routing of control and main circuit wires). Also, perform the same check as described in (1) above. → Improve noise control. Alternatively, return the initialized function code data to their previous settings, then restart the operation.
(3) The control circuit failed.	Initialize the function code data by setting H03 to 1, then reset the alarm by pressing the  key and check that the alarm goes on. → This problem was caused by a problem of the printed circuit board (PCB) (on which the CPU is mounted). Contact your Fuji Electric representative.

[13] E_{r-2} Remote keypad communications error

Problem A communications error occurred between the remote keypad and the inverter.

Possible Causes	What to Check and Suggested Measures
(1) Break in the communications cable or poor contact.	Check continuity of the cable, contacts and connections. → Replace the cable.
(2) A high intensity noise was given to the inverter.	Check if appropriate noise control measures have been implemented (e.g., correct grounding and routing of control and main circuit wires). → Improve noise control. For details, refer to "Appendix A" of the FRENIC-Mini User's Manual (MEH446).
(3) The remote keypad malfunctioned.	Check that alarm E_{r-2} does not occur if you connect another remote keypad to the inverter. → Replace the remote keypad.
(4) The RS-485 communications card malfunctioned.	Check that alarm E_{r-2} occurs even if you connect another remote keypad to the inverter. → Replace the card.

[14] E_{r-3} CPU error

Problem A CPU error (e.g. erratic CPU operation) occurred.

Possible Causes	What to Check and Suggested Measures
(1) A high intensity noise was given to the inverter.	Check if appropriate noise control measures have been implemented (e.g. correct grounding and routing of control and main circuit wires). → Improve noise control.

[15] *E-r* Operation protection

Problem An error occurred due to incorrect operation of the motor.

Possible Causes	What to Check and Suggested Measures
(1) The  key was pressed when H96 = 1 or 3.	Even though a run command was present at the input terminal or the communication port, the inverter was forced to decelerate to stop and <i>E-r</i> was displayed. → If this was not intended, check the setting of H96.
(2) The start check function was activated when H96 = 2 or 3.	When one of the following conditions occurred while a run command was present at the input, the inverter did not run and <i>E-r</i> was displayed: - The power was switched on - An alarm was released - The inverter was switched to link command <i>LE</i> operation. → Review the running sequence to avoid input of the run command when <i>E-r</i> has occurred. If this was not intended, check the setting of H96. (To reset the alarm, turn the run command off.)

[16] *E-B* RS-485 communications error



Problem A communications error occurred during RS-485 communications.

Possible Causes	What to Check and Suggested Measures
(1) Host controllers (e.g., PLCs and personal computers) did not operate due to incorrect settings and/or defective software/hardware.	Check the controllers. → Remove the cause of the controller error.
(2) RS-485 converter did not operate due to incorrect connections and settings, or hardware defective.	Check the RS-485 converter (e.g., check for poor contact). → Change the various RS-485 converter settings, reconnect the wires, or replace the converter with a recommended device as appropriate.
(3) Broken communications cable or poor contact.	Check continuity of the cable, contacts and connections. → Replace the cable.
(4) Even though no response error detection time (y08) has been set, communications did not occur cyclically.	Check the host controllers. → Change the settings of host controller software, or make the no response error detection time invalid (y08=0).
(5) A high intensity noise was given to the inverter.	Check if appropriate noise control measures have been implemented (e.g., correct grounding and routing of control and main circuit wires). → Improve noise control. → Improve noise reduction measures on the host side. → Replace the relay converter with a recommended insulated converter.

Possible Causes	What to Check and Suggested Measures
(6) Conditions for communications differ between the inverter and host controllers.	Compare the settings of the y codes (y01 to y10) with those of the host controllers. → Correct any settings that differ.
(7) The RS-485 communications card malfunctioned.	→ Replace the card.

[17] *E-r-F* Data save error during undervoltage



Problem The inverter was unable to save data such as the frequency commands, timer operation time, and PID process command set through the keypad when the power was switched off.

Possible Causes	What to Check and Suggested Measures
(1) The control circuit voltage dropped suddenly while data was being saved when the power was turned off, because the DC link bus was rapidly discharged.	Check how long it takes for the DC link bus voltage to drop to the preset voltage when power is turned off. → Remove whatever is causing the rapid discharge of the DC link circuit. After pressing the  key and releasing the alarm, set, using a remote keypad, the data of the relevant function codes (such as the frequency commands, timer operation time, and PID process command) back to the original values and then restart the operation.
(2) A high intensity noise affected the operation of the inverter while data was being saved when the power was turned off.	Check if appropriate noise control measures have been implemented (e.g., correct grounding and routing of control and main circuit wires). → Improve noise control. After pressing the  key and releasing the alarm, set, using a remote keypad, the data of the relevant function codes (such as the frequency commands, timer operation time, and PID process command) back to the original values and then restart the operation.
(3) The control circuit failed.	Check if <i>E-r-F</i> occurs each time power is switched off. → This problem was caused by a problem of the printed circuit board (PCB) (on which the CPU is mounted). Contact your Fuji Electric representative.

6.4 If an Abnormal Pattern Appears on the LED Monitor while No Alarm Code is Displayed

[1] ---- (center bar) appears

Problem A center bar (----) has appeared on the LED monitor.

Possible Causes	What to Check and Suggested Measures
<p>(1) When PID control had been disabled (J01=0), you changed E43 (item selection) to 10 or 12.</p> <p>You disabled PID control (J01=0) when the LED monitor had been set to display the PID final command value or PID feedback amount by pressing the  key.</p>	<p>Make sure that when you wish to view other monitor items, E43 is not set to "10" or "12."</p> <p>→ Set E43 to a value other than "10" or "12."</p> <p>Make sure that when you wish to view a PID process command or a PID control command, PID control is still in effect or J01 is not set to 0.</p> <p>→ Set J01 to 1 or 2.</p>
<p>(2) While timer operation is disabled (C21=0), E43 (item selection) has been set for 10 or 12.</p> <p>While timer operation is enabled (C21=1), it has been disabled (C21=0) during setting the LED monitor to display the timer value by pressing the  key.</p>	<p>Make sure that when you wish to view other monitor items, E43 is not set to "13."</p> <p>→ Set E43 to a value other than "13."</p> <p>Make sure that when you wish to view the timer (s), timer operation is still in effect or C21 is not set to 0.</p> <p>→ Set C21 to 1.</p>
<p>(3) Connection to the remote keypad was broken.</p>	<p>Prior to proceed, check that pressing the  key does not take effect for the LED display.</p> <p>Check connectivity of the cable for the remote keypad.</p> <p>→ Replace the cable.</p> <p>Check whether the connector on the RS-485 Communications Card or on the remote keypad is not broken.</p> <p>→ Replace the RS-485 Communications Card or the remote keypad with a new one.</p>

[2] _ _ _ _ (under bar) appears

Problem An under bar (_ _ _ _) appeared on the LED monitor when you pressed the  key or entered a normal start/stop command **FWD** or a reverse start/stop command **REV**. The motor did not start.

Possible Causes	What to Check and Suggested Measures
(1) The voltage of the DC link bus was low (F14 = 4, 5).	Select <u>S_01</u> under Menu #5 "Reading maintenance information" in Programming mode on the keypad, and check the voltage of the DC link bus, which should be: 200 VDC or below for three-phase 200 V, single-phase 200 V, and single-phase 100 V; and 400 VDC or below for three-phase 400 V. → Plug the inverter to a power supply that meets its input specifications.

[3] [] appears

Problem Parentheses ([]) has appeared on the LED monitor while the keypad displaying the Drive Monitor.

Possible Causes	What to Check and Suggested Measures
(1) The data to be displayed could not fit the LED monitor.	Check that the product of the output frequency and the display coefficient (E50) does not exceed 9999. → Adjust the setting of E50.

Chapter 7 MAINTENANCE AND INSPECTION

Perform daily and periodic inspection to avoid trouble and keep reliable operation for a long time. Take care of the following items during work.

WARNING

- Before starting inspection and maintenance, first turn off the inverter and wait at least 5 minutes. This is because the electric charge in the DC link bus capacitor may remain even after the power is turned off and it may take time until the DC link bus voltage drops below a safe potential. After 5 minutes or more, remove the control circuit and main circuit terminal block covers. Make sure that the DC link bus voltage between the terminals P (+) and N (-) has dropped below the safe voltage level (+25 VDC), using a multimeter and then start the maintenance and inspection.

Electric shock may occur.

- Maintenance, inspection, and parts replacement should be made only by authorized persons.
- Take off the watch, rings and other metallic matter before starting work.
- Use insulated tools.
- Never modify the inverter.

Electric shock or injuries could occur.

7.1 Daily Inspection

Visually inspect errors in the state of operation from the outside without removing the covers while the inverter operates or while it is turned on.

- Check if the expected performance (satisfying the standard specification) is obtained.
- Check if the surrounding environment satisfies Chapter 2, Section 2.1 "Operating Environment."
- Check that the LED monitor displays normally.
- Check for abnormal noise, odor, or excessive vibration.
- Check for traces of overheat, discoloration and other defects.

7.2 Periodic Inspection

Perform periodic inspection by following the items of the list of periodic inspection in Table 7.1. Before performing periodic inspection, be sure to stop the motor, turn off the inverter, and shut down power supply. Then remove the covers of the control and main circuit terminal blocks.

Table 7.1 List of Periodic Inspections

Check part	Check item	How to inspect	Evaluation criteria
Environment	1) Check the ambient temperature, humidity, vibration and atmosphere (dust, gas, oil mist, or water drops). 2) Check if tools or other foreign matter or dangerous objects are left around the equipment.	1) Check visually or measure using apparatus. 2) Visual inspection	1) The standard specification must be satisfied. 2) No foreign or dangerous objects are left.
Voltage	Check if the voltages of the main and control circuit are correct.	Measure the voltages using a multimeter or the like.	The standard specification must be satisfied.
Keypad	1) Check if the display is clear. 2) Check if there is missing parts in the characters.	1), 2) Visual inspection	1), 2) The display can be read and there is no fault.
Structure such as frame and cover	1) Abnormal noise and excessive vibration 2) Loosen bolts (tightened parts) 3) Deformation and breakage 4) Discoloration and deformation caused by overheat 5) Check for foulness and dust.	1) Visual or hearing inspection 2) Retighten. 3), 4), 5) Visual inspection	1), 2), 3), 4), 5) No abnormalities
Main circuit	Common	1) Retighten. 2), 3) Visual inspection	1), 2), 3) No abnormalities
	Conductor and wire	1), 2) Visual inspection	1), 2) No abnormalities
	Terminal block	Visual inspection	No abnormalities

Table 7.1 Continued

Check part		Check item	How to inspect	Evaluation criteria
Main circuit	Filtering capacitor (Note)	1) Check for electrolyte leakage, discoloration, cracks and swelling of the case. 2) Check if the safety valve does not protrude remarkably. 3) Measure the capacitance if necessary.	1),2) Visual inspection 3) Measure discharge time with capacitance probe.	1),2) No abnormalities 3) The discharge time is not shorter than time specified by the replacement manual.
	Braking resistor	1) Check for odor caused by overheat and cracked insulator. 2) Check for broken wire.	1) Smelling and visual inspection 2) Visual inspection or measurement with multimeter under disconnection of one lead	1) No abnormalities 2) Within $\pm 10\%$ of the specified resistance
	Transformer and reactor	Check for abnormal roaring noise and odor.	Hearing, visual and smelling inspection	No abnormalities
	Magnetic contactor and relay	1) Check for chatters during operation. 2) Check for rough contacts.	1) Hearing inspection 2) Visual inspection	1), 2) No abnormalities
Control circuit	Printed circuit board (Note)	1) Check for loose screws and connectors. 2) Check for odor and discoloration. 3) Check for cracks, breakage, deformation and remarkable rust. 4) Check the capacitors for electrolyte leaks and deformation.	1) Retighten. 2) Smelling and visual inspection 3), 4) Visual inspection	1), 2), 3), 4) No abnormalities
Cooling system	Cooling fan (Note)	1) Check for abnormal noise and excessive vibration. 2) Check for loose bolts. 3) Check for discoloration caused by overheat.	1) Hearing and visual inspection, or turn manually (be sure to turn the power off). 2) Retighten. 3) Visual inspection	1) Smooth rotation 2), 3) No abnormalities
	Ventilation path	Check the heat sink, intake and exhaust ports for clogging and foreign matter.	Visual inspection	No abnormalities

(Note) The judgement level of part replacement period with Menu #5 "Maintenance information" should be used as a guide. Determine the replacement period on the basis of the standard replacement years. (See Section 7.5 "List of Periodical Replacement Parts.")

If the inverter is stained, wipe it off with a chemically neutral cloth to remove dust, use a vacuum cleaner.

■ Judgement of service life using maintenance information

Menu #5 "Maintenance information" in Programming mode can be used to display data for the judgement of replacement of "DC link bus capacitor," "electrolytic capacitor on the printed circuit board," and "cooling fan" as a guide.

If the replacement data is out of the judgement level for early warning, an early warning signal is output to an external device through terminal [Y1] (function code E20). (When any replacement data is out of the judgement level, terminal [Y1] outputs ON signal.)

Table 7.2 Parts Replacement Judgement with Menu #5 "Maintenance Information"

Parts to be replaced	Judgement level
DC link bus capacitor	85% or lower of the capacitance than that of the factory setting
Electrolytic capacitor on the printed circuit board	61,000 hours or longer as accumulated run time
Cooling fan (Nominal applied motor: 1.5 to 3.7 kW)	61,000 hours or longer as accumulated run time (Assumed life of cooling fan at ambient inverter temperature of 40°C)

(1) DC link bus capacitor

Measure the capacitance of the DC link bus capacitor as follows:

The capacitance is displayed in the reduction ratio (%) of the initial value written in the inverter memory before shipment.

----- Capacitance measurement procedure -----

- 1) Remove the RS-485 communications card (option) from the inverter if it is mounted. Disconnect the DC link bus to other inverters from terminals P (+) and N (-) of the main circuit if any. A DC reactor (option) and braking resistor (option) may not be disconnected. Keep the ambient temperature at $25 \pm 10^{\circ}\text{C}$.
 - 2) Turn off the digital inputs (FWD, REV, and X1 to X3) at the control terminals.
 - If an external potentiometer is connected, to terminal [13], remove it.
 - Set the data of function codes E20 and E27 as the transistor output [Y1] or relay output [30A, B, C] does not come on while the inverter power is turned off. E.g., recommended settings are to assign normal logic signal **RUN** and **ALM** to terminals [Y1] and [30A, B, C] respectively.
 - 3) Turn the inverter power on.
 - 4) Check that the cooling fan rotates and the inverter is on halt.
 - 5) Turn the main power supply off. Start measuring the capacitance of the DC link bus capacitor.
 - 6) After the LED monitor is unlit completely, turn the main power supply on again.
 - 7) Select Menu #5 "Maintenance information" in Programming mode, and check the reduction ratio (%) of the capacitance of the DC link bus capacitor.
-

(2) Electrolytic capacitor on the printed circuit board

The inverter keeps an accumulative total of the number of hours that power has been applied to the control circuit and displays it on the LED monitor. Use this to determine when the capacitor should be replaced. The display is in units of 1000 hours.

(3) Cooling fan

The inverter accumulates hours for which the cooling fan has run. The display is in units of 1000 hours.

The accumulated time should be used just a guide since the actual service life will be significantly affected by the temperature and operation environment.

7.3 Measurement of Electrical Amounts in Main Circuit

Because the voltage and current of the power supply (input, primary circuit) of the main circuit of the inverter and those of the motor (output, secondary circuit) include harmonic components, the readings may vary with the type of the meter. Use meters indicated in Table 7.3 when measuring with meters for commercial frequencies.

The power factor cannot be measured by a commercially available power-factor meter that measures the phase difference between the voltage and current. To obtain the power factor, measure the power, voltage and current on each of the input and output sides and calculate in the following formula.

■ Three-phase input

$$\text{Power factor} = \frac{\text{Electric power (W)}}{\sqrt{3} \times \text{Voltage (V)} \times \text{Current (A)}} \times 100\%$$

■ Single-phase input

$$\text{Power factor} = \frac{\text{Electric power (W)}}{\text{Voltage (V)} \times \text{Current (A)}} \times 100\%$$

Table 7.3 Meters for Measurement of Main Circuit

Item	Input (primary) side			Output (secondary) side			DC link bus voltage (P (+)-N (-))
Waveform	Voltage 		Current 	Voltage 		Current 	
Name of meter	Ammeter AR, AS, AT	Voltmeter VR, VS, VT	Wattmeter WR, WT	Ammeter AU, AV, AW	Voltmeter VU, VV, VW	Wattmeter WU, WW	DC voltmeter V
Type of meter	Moving iron type	Rectifier or moving iron type	Digital AC power meter	Digital AC power meter	Digital AC power meter	Digital AC power meter	Moving coil type
Symbol of meter			—	—	—	—	

Note It is not recommended that meters other than a digital AC power meter be used for measuring the output voltage or output current since they may cause larger measurement errors or, in the worst case, they may be damaged.

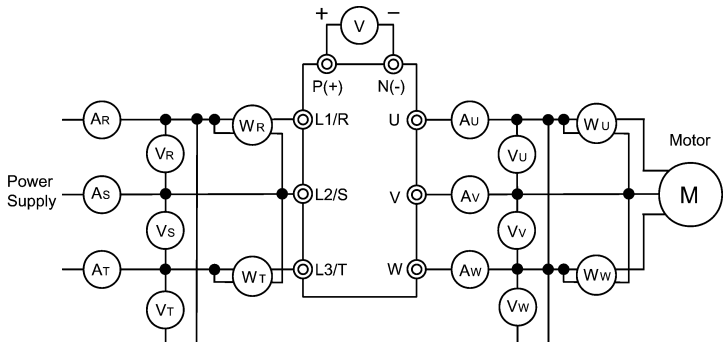

Figure 7.1 Connection of Meters

7.4 Insulation Test

Because an insulation test is made in the factory before shipment, avoid a Megger test.

If a Megger test is unavoidable, follow the procedure below. Because a wrong test procedure will cause breakage of the inverter, take sufficient care.

A dielectric strength test will cause breakage of the inverter similarly to the Megger test if the test procedure is wrong. When the dielectric strength test is necessary, contact your Fuji Electric representative.

(1) Megger test of main circuit

- 1) Use a 500 VDC Megger and shut off the main power supply without fail during measurement.
- 2) If the test voltage leaks to the control circuit due to the wiring, disconnect all the control wiring.
- 3) Connect the main circuit terminals with a common cable as shown in Figure 7.2.
- 4) The Megger test must be limited to across the common line of the main circuit and ground (⊕).
- 5) 5 M Ω (1 M Ω for the EMC filter built-in type of inverters) or a larger value displayed at the Megger indicates a correct state. (The value is for a discrete inverter.)

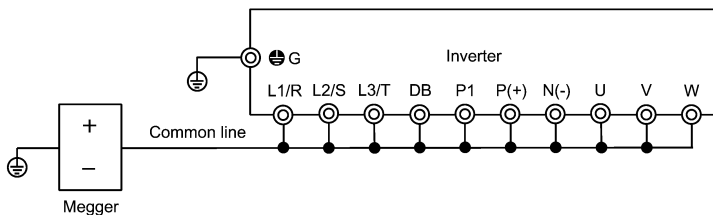

Figure 7.2 Megger Test

(2) Dielectric strength test of control circuit

Do not perform a Megger test or dielectric strength test for the control circuit. Prepare a high resistance range tester for the control circuit.

- 1) Disconnect all the external wiring from the control circuit terminals.
- 2) Perform a continuity test to the ground. 1 M Ω or a larger measurement indicates a correct state.

(3) Dielectric strength test of external main circuit and sequence control circuit

Disconnect all the inverter terminals so that the test voltage is not applied.

7.5 List of Periodical Replacement Parts

Each part of the product has its own service life that will vary according to the environmental and operating conditions. It is recommended that the following parts be replaced as specified below.

When the replacement is necessary, contact your Fuji Electric representative.

Table 7.4 Replacement Parts

Part name	Standard replacement intervals
Cooling fan	5 years
DC link bus capacitor	5 years
Electrolytic capacitor on the printed circuit board	7 years

7.6 Inquiries about Product and Guarantee

7.6.1 When making an inquiry

Upon breakage of the product, uncertainties, failure or inquiries, report the following information to your Fuji Electric representative.

- 1) Inverter type
- 2) SER No. (serial number of equipment)
- 3) Function code data that you changed from the factory defaults
- 4) ROM version
- 5) Date of purchase
- 6) Inquiries (for example, point and extent of breakage, uncertainties, failure phenomena, and other circumstances)

7.6.2 Product warranty

To all our customers who purchase Fuji Electric FA Components & Systems' products:

Please take the following items into consideration when placing your order.

When requesting an estimate and placing your orders for the products included in these materials, please be aware that any items such as specifications which are not specifically mentioned in the contract, catalog, specifications or other materials will be as mentioned below.

In addition, the products included in these materials are limited in the use they are put to and the place where they can be used, etc., and may require periodic inspection. Please confirm these points with your sales representative or directly with this company.

Furthermore, regarding purchased products and delivered products, we request that you take adequate consideration of the necessity of rapid receiving inspections and of product management and maintenance even before receiving your products.

[1] Free of charge warranty period and warranty range

(1) Free of charge warranty period

- 1) The product warranty period is "1 year from the date of purchase" or 24 months from the manufacturing date imprinted on the name place, whichever date is earlier.
- 2) However, in cases where the use environment, conditions of use, use frequency and times used, etc., have an effect on product life, this warranty period may not apply.
- 3) Furthermore, the warranty period for parts restored by Fuji Electric's Service Department is "6 months from the date that repairs are completed."

(2) Warranty range

- 1) In the event that breakdown occurs during the product's warranty period which is the responsibility of Fuji Electric, Fuji Electric will replace or repair the part of the product that has broken down free of charge at the place where the product was purchased or where it was delivered. However, if the following cases are applicable, the terms of this warranty may not apply.
 - ① The breakdown was caused by inappropriate conditions, environment, handling or use methods, etc. which are not specified in the catalog, operation manual, specifications or other relevant documents.
 - ② The breakdown was caused by the product other than the purchased or delivered Fuji's product.
 - ③ The breakdown was caused by the product other than Fuji's product, such as the customer's equipment or software design, etc.
 - ④ Concerning the Fuji's programmable products, the breakdown was caused by a program other than a program supplied by this company, or the results from using such a program.
 - ⑤ The breakdown was caused by modifications or repairs affected by a party other than Fuji Electric.
 - ⑥ The breakdown was caused by improper maintenance or replacement using consumables, etc. specified in the operation manual or catalog, etc.
 - ⑦ The breakdown was caused by a chemical or technical problem that was not foreseen when making practical application of the product at the time it was purchased or delivered.
 - ⑧ The product was not used in the manner the product was originally intended to be used.
 - ⑨ The breakdown was caused by a reason which is not this company's responsibility, such as lightning or other disaster.
- (2) Furthermore, the warranty specified herein shall be limited to the purchased or delivered product alone.
- (3) The upper limit for the warranty range shall be as specified in item (1) above and any damages (damage to or loss of machinery or equipment, or lost profits from the same, etc.) consequent to or resulting from breakdown of the purchased or delivered product shall be excluded from coverage by this warranty.

(3) Trouble diagnosis

As a rule, the customer is requested to carry out a preliminary trouble diagnosis. However, at the customer's request, this company or its service network can perform the trouble diagnosis on a chargeable basis. In this case, the customer is asked to assume the burden for charges levied in accordance with this company's fee schedule.

[2] Exclusion of liability for loss of opportunity, etc.

Regardless of whether a breakdown occurs during or after the free of charge warranty period, this company shall not be liable for any loss of opportunity, loss of profits, or damages arising from special circumstances, secondary damages, accident compensation to another company, or damages to products other than this company's products, whether foreseen or not by this company, which this company is not be responsible for causing.

[3] Repair period after production stop, spare parts supply period (holding period)

Concerning models (products) which have gone out of production, this company will perform repairs for a period of 7 years after production stop, counting from the month and year when the production stop occurs. In addition, we will continue to supply the spare parts required for repairs for a period of 7 years, counting from the month and year when the production stop occurs. However, if it is estimated that the life cycle of certain electronic and other parts is short and it will be difficult to procure or produce those parts, there may be cases where it is difficult to provide repairs or supply spare parts even within this 7-year period. For details, please confirm at our company's business office or our service office.

[4] Transfer rights

In the case of standard products which do not include settings or adjustments in an application program, the products shall be transported to and transferred to the customer and this company shall not be responsible for local adjustments or trial operation.

[5] Service contents

The cost of purchased and delivered products does not include the cost of dispatching engineers or service costs. Depending on the request, these can be discussed separately.

[6] Applicable scope of service

Above contents shall be assumed to apply to transactions and use of the country where you purchased the products.

Consult the local supplier or Fuji for the detail separately.

Chapter 8 SPECIFICATIONS

8.1 Standard Models

8.1.1 Three-phase 200 V class series

Item		Specifications								
Power supply voltage		Three-phase 200 V								
Type (FRN ___ C1S-2□)		0.1	0.2	0.4	0.75	1.5	2.2	3.7		
Nominal applied motor (kW)		*1	0.1	0.2	0.4	0.75	1.5	2.2	3.7	
Output Ratings	Rated capacity (kVA)	*2	0.3	0.57	1.1	1.9	3.0	4.2	6.5	
	Rated voltage (V)	*3	Three-phase, 200 V/50 Hz, 200 V, 220 V, 230 V/60 Hz							
	Rated current (A)	*4	0.8 (0.7)	1.5 (1.4)	3.0 (2.5)	5.0 (4.2)	8.0 (7.0)	11.0 (10.0)	17.0 (16.5)	
	Overload capability		150% of rated output current for 1 min. 200% of rated output current for 0.5 s							
	Rated frequency (Hz)		50, 60 Hz							
Input Ratings	Phases, voltage, frequency		Three-phase, 200 to 240 V, 50/60 Hz							
	Voltage and frequency variations		Voltage : +10 to -15% (Interphase voltage unbalance*5: 2 % or less) Frequency: +5 to -5%							
	Momentary voltage dip capability	*6	When the input voltage is 165 V or more, the inverter may keep running. Even if it drops below 165 V, the inverter may keep running for 15 ms.							
	Rated current (A)	(w/ DCR) *7	0.57	0.93	1.6	3.0	5.7	8.3	14.0	
	(w/o DCR)	1.1	1.8	3.1	5.3	9.5	13.2	22.2		
	Required power supply capacity (kVA)	*8	0.2	0.3	0.6	1.1	2.0	2.9	4.9	
Braking	Torque (%)	*9	150		100		50		30	
	Torque (%)	*10	-		150					
	DC injection braking		Starting frequency: 0.0 to 60.0 Hz Braking time: 0.0 to 30.0 s Braking level: 0 to 100% of rated current							
Enclosure (IEC60529)			IP20, UL open type**11							
Cooling method			Natural cooling				Fan cooling			
Mass (kg)			0.6	0.6	0.6	0.7	1.7	1.7	2.3	

*1 Fuji 4-pole standard motors

*2 The rated capacity is for 220 V output voltage.

*3 Output voltages cannot exceed the power supply voltage.

*4 Use the inverter at the current given in () or below when the carrier frequency command is higher than 4 kHz ($f_{cs} = 4$ to 15) or the ambient temperature is 40°C or higher.

*5 Interphase voltage unbalance (%) = $\frac{\text{Max. voltage (V)} - \text{Min. voltage (V)}}{\text{Three-phase average voltage (V)}} \times 67$ (Refer to IEC 61800 -3 (5.2.3))

If this value is 2 to 3 %, use an AC reactor (ACR).

*6 Tested under the standard load condition (85% load for applicable motor rating).

*7 Calculated under Fuji-specified conditions.

*8 Indicates the value when using a DC reactor (option).

*9 Average braking torque obtained with the AVR control off ($f_{cs} = 0$). (Varies according to the efficiency of the motor.)

*10 Average braking torque obtained by use of an external braking resistor (standard type available as option).

*11 To make FRENIC-Mini compliant with category TYPE1 of the UL Standard (or NEMA1), an optional NEMA1 kit is required. Note that the TYPE1-compliant FRENIC-Mini should be used in the ambient temperature range from -10 to +40°C.

Note: A box (□) in the above table replaces A, C, E, or J depending on the shipping destination.

8.1.2 Three-phase 400 V class series

Item		Specifications					
Power supply voltage		Three-phase 400 V					
Type (FRN ___ C1S-4□)		0.4	0.75	1.5	2.2	3.7, 4.0	
Nominal applied motor (kW) *1		0.4	0.75	1.5	2.2	3.7, 4.0	
Output Ratings	Rated capacity (kVA) *2	1.1	1.9	2.8	4.1	6.8	
	Rated voltage (V) *3	Three-phase, 380, 400, 415 V/50 Hz, 380, 400, 440, 460 V/60 Hz					
	Rated current (A)	1.5	2.5	3.7	5.5	9.0	
	Overload capability	150% of rated output current for 1 min. 200% of rated output current for 0.5 s					
Rated frequency (Hz)		50, 60 Hz					
Phases, voltage, frequency		Three-phase, 380 to 480 V, 50/60 Hz					
Voltage and frequency variations		Voltage : +10 to -15% (Interphase voltage unbalance*4: 2% or less) Frequency: +5 to -5%					
Momentary voltage dip capability *5		When the input voltage is 300 V or more, the inverter may keep running. Even if it drops below 300 V, the inverter may keep running for 15 ms.					
Input Ratings	Rated current (A) *6	(w/ DCR)	0.85	1.6	3.0	4.4	7.3
		(w/o DCR)	1.7	3.1	5.9	8.2	13.0
	Required power supply capacity (kVA) *7	0.6	1.1	2.0	2.9	4.9	
Braking	Torque (%) *8	100			30		
	Torque (%) *9	150					
	DC injection braking	Starting frequency: 0.0 to 60.0 Hz Braking time: 0.0 to 30.0 s Braking level: 0 to 100% of rated current					
Enclosure (IEC60529)		IP20, UL open type *10					
Cooling method		Natural cooling		Fan cooling			
Mass (kg)		1.1	1.2	1.7	1.7	2.3	

*1 Fuji 4-pole standard motors

*2 The rated capacity is for 440 V output voltage.

*3 Output voltages cannot exceed the power supply voltage.

*4 Interphase voltage unbalance (%) = $\frac{\text{Max.voltage (V)} - \text{Min.voltage (V)}}{\text{Three-phase average voltage (V)}} \times 67$ (Refer to IEC 61800 -3 (5.2.3))

If this value is 2 to 3 %, use an AC reactor (ACR).

*5 Tested under the standard load condition (85% load for applicable motor rating).

*6 Calculated under Fuji-specified conditions.

*7 Indicates the value when using a DC reactor (option).

*8 Average braking torque obtained with the AVR control off ($F_{DS} = 0$). (Varies according to the efficiency of the motor.)

*9 Average braking torque obtained by use of an external braking resistor (standard type available as option).

*10 To make FRENIC-Mini compliant with category TYPE1 of the UL Standard (or NEMA1), an optional NEMA1 kit is required. Note that the TYPE1-compliant FRENIC-Mini should be used in the ambient temperature range from -10 to +40°C.

Note: A box (□) in the above table replaces A, C, E, or J depending on the shipping destination. Note that the FRN4.0C1S-4 can be followed by E only.

8.1.3 Single-phase 200 V class series

Item		Specifications					
Power supply voltage		Single-phase 200 V					
Type (FRN ___ C1S-7□)		0.1	0.2	0.4	0.75	1.5	2.2
Nominal applied motor (kW) *1		0.1	0.2	0.4	0.75	1.5	2.2
Output Ratings	Rated capacity (kVA) *2	0.3	0.57	1.1	1.9	3.0	4.1
	Rated voltage (V) *3	Three-phase, 200 V/50 Hz, 200 V, 220 V, 230 V/60 Hz					
	Rated current (A) *4	0.8 (0.7)	1.5 (1.4)	3.0 (2.5)	5.0 (4.2)	8.0 (7.0)	11.0 (10.0)
	Overload capability	150% of rated output current for 1 min. 200% of rated output current for 0.5 s					
	Rated frequency (Hz)	50, 60 Hz					
Input Ratings	Phases, voltage, frequency	Single-phase, 200 to 240 V, 50/60 Hz					
	Voltage and frequency variations	Voltage : +10 to -10% Frequency: +5 to -5%					
	Momentary voltage dip capability *5	When the input voltage is 165 V or more, the inverter may keep running. Even if it drops below 165 V, the inverter may keep running for 15 ms.					
	Rated current (A) *6	(w/ DCR)	1.1	2.0	3.5	6.4	11.6
	(w/o DCR)	1.8	3.3	5.4	9.7	16.4	24.8
	Required power supply capacity (kVA) *7	0.3	0.4	0.7	1.3	2.4	3.5
Braking	Torque (%) *8	150		100		50	30
	Torque (%) *9	-		150			
	DC injection braking	Starting frequency: 0.0 to 60.0 Hz Braking time: 0.0 to 30.0 s Braking level: 0 to 100% of rated current					
Enclosure (IEC60529)	IP20, UL open type *10						
Cooling method	Natural cooling				Fan cooling		
Mass (kg)	0.6	0.6	0.6	0.8	1.6	2.3	

*1 Fuji 4-pole standard motors

*2 The rated capacity is for 220 V output voltage.

*3 Output voltages cannot exceed the power supply voltage.

*4 Use the inverter at the current given in () or below when the carrier frequency command is higher than 4 kHz ($F_{\text{CS}} = 4$ to 15) or the ambient temperature is 40°C or higher.

*5 Tested under the standard load condition (85% load for applicable motor rating).

*6 Calculated under Fuji-specified conditions.

*7 Indicates the value when using a DC reactor (option).

*8 Average braking torque obtained with the AVR control off ($F_{\text{DS}} = 0$). (Varies according to the efficiency of the motor.)

*9 Average braking torque obtained by use of an external braking resistor (standard type available as option).

*10 To make FRENIC-Mini compliant with category TYPE1 of the UL Standard (or NEMA1), an optional NEMA1 kit is required. Note that the TYPE1-compliant FRENIC-Mini should be used in the ambient temperature range from -10 to +40°C.

Note: A box (□) in the above table replaces A, C, E, or J depending on the shipping destination.

8.1.4 Single-phase 100 V class series

Item		Specifications					
Power supply voltage		Single-phase 100 V					
Type (FRN ___ C1S-6□)		0.1	0.2	0.4	0.75		
Nominal applied motor (kW)	*1	0.1	0.2	0.4	0.75		
Output Ratings	Rated capacity (kVA)	*2	0.26	0.53	0.95	1.6	
	Rated voltage (V)	*3	Three-phase, 200 V/50 Hz, 200 V, 220 V, 230 V/60 Hz				
	Rated current (A)		0.7	1.4	2.5	4.2	
	Overload capability		150% of rated output current for 1 min. 200% of rated output current for 0.5 s				
	Rated frequency (Hz)		50, 60 Hz				
Input Ratings	Phases, voltage, frequency		Single-phase, 100 to 120 V, 50/60 Hz				
	Voltage and frequency variations		Voltage : +10 to -10% Frequency: +5 to -5%				
	Momentary voltage dip capability	*4	When the input voltage is 85 V or more, the inverter may keep running. Even if it drops below 85 V, the inverter may keep running for 15 ms.				
	Rated current (A)	*5	(w/ DCR)	2.2	3.8	6.4	12.0
			(w/o DCR)	3.6	5.9	9.5	16.1
	Required power supply capacity (kVA)	*6	0.3	0.5	0.7	1.3	
Braking	Torque (%)	*7	150		100		
	Torque (%)	*8	-		150		
	DC injection braking		Starting frequency: 0.0 to 60.0 Hz Braking time: 0.0 to 30.0 s Braking level: 0 to 100% of rated current				
Enclosure (IEC60529)		IP20, UL open type*9					
Cooling method		Natural cooling					
Mass (kg)		0.6	0.6	0.7	1.2		

*1 Fuji 4-pole standard motors

*2 The rated capacity is for 220 V output voltage.

*3 The inverter cannot output voltage that is 2 or more times its rated voltage.

*4 Tested under the standard load condition (85% load for applicable motor rating).

*5 Calculated under Fuji-specified conditions.

*6 Indicates the value when using a DC reactor (option).

*7 Average braking torque obtained with the AVR control off ($F_{DS} = 0$). (Varies according to the efficiency of the motor.)

*8 Average braking torque obtained by use of an external braking resistor (standard type available as option).

*9 To make FRENIC-Mini compliant with category TYPE1 of the UL Standard (or NEMA1), an optional NEMA1 kit is required. Note that the TYPE1-compliant FRENIC-Mini should be used in the ambient temperature range from -10 to +40°C.

Note 1: A box (□) in the above table replaces A, C, E, or J depending on the shipping destination.

2: When driven by 100 VAC, the single-phase 100 V class series of inverters limit their shaft output and maximum output torque as listed below. This is to prevent their output voltage from decreasing when load is applied.

	Shaft output (%)	Maximum torque (%)
w/o DC reactor (DCR)	90	150
w/ DC reactor (DCR)	85	120

8.2 Models Available on Order

In the EU version, the EMC filter built-in type is provided as a standard model. In other versions, it is available on order.

8.2.1 EMC filter built-in type

■ Three-Phase 200 and 400 V class series

Item	Specifications											
	Three-phase 200 V							Three-phase 400 V				
Power supply voltage												
Type (FRN ___ C1E-*□)	0.1	0.2	0.4	0.75	1.5	2.2	3.7	0.4	0.75	1.5	2.2	3.7, 4.0
Applicable motor rating (kW) *1	0.1	0.2	0.4	0.75	1.5	2.2	3.7	0.4	0.75	1.5	2.2	3.7, 4.0
Weight (kg)	0.7	0.7	0.7	0.8	2.4	2.4	2.9	1.5	1.6	2.5	2.5	3.0

*1 Fuji 4-pole standard motors

Note 1: An asterisk (*) in the above table replaces numbers which denote the following:

2: three-Phase 200 V, 4: three-Phase 400 V

Note 2: A box (□) in the above table replaces A, C, E, or J depending on the shipping destination. Note that the FRN4.0C1E-4 can be followed by E only.

Other than those items in the above table are the same as those in Section 8.1 "Standard Models."

■ Single-phase 200 V class series

Item	Specifications					
	Single-phase 200 V					
Power supply voltage						
Type (FRN ___ C1E-7□)	0.1	0.2	0.4	0.75	1.5	2.2
Applicable motor rating (kW) *1	0.1	0.2	0.4	0.75	1.5	2.2
Weight (kg)	0.7	0.7	0.7	1.2	2.4	2.9

*1 Fuji 4-pole standard motors

Note 1: A box (□) in the above table replaces A, C, E, or J depending on the shipping destination.

Other than those items in the above table are the same as those in Section 8.1 "Standard Models."

8.2.2 Braking resistor built-in type

■ Three-Phase 200 and 400 V class series

Item	Specifications						
	Three-phase 200 V				Three-phase 400 V		
Power supply voltage							
Type (FRN ___ C1S-*□21)	1.5	2.2	3.7	1.5	2.2	3.7, 4.0	
Applicable motor rating (kW) *1	1.5	2.2	3.7	1.5	2.2	3.7, 4.0	
Braking	Torque (%)	150	100	100	150	100	
	Braking time (s)	18	12	8	18	12	
	Duty cycle (%)	3	2	1.5	3	2	
	Weight (kg)	1.8	1.8	2.5	1.8	1.8	

*1 Fuji 4-pole standard motors

Note 1: An asterisk (*) in the above table replaces numbers which denote the following:

2: three-Phase 200 V, 4: three-Phase 400 V

Note 2: A box (□) in the above table replaces A, C, E, or J depending on the shipping destination. Note that the FRN4.0C1S-4 can be followed by E only.

Other than those items in the above table are the same as those in Section 8.1 "Standard Models."

8.3 Common Specifications

Item		Detail specifications
Output frequency	Setting range	Maximum frequency 25.0 to 400.0 Hz Base frequency 25.0 to 400.0 Hz Starting frequency 0.1 to 60.0 Hz Carrier frequency 0.75 k to 15 kHz Frequency may drop automatically to protect the inverter running at 7 kHz or more. This protective operation can be cancelled by function code H98.
	Accuracy (Stability)	Analog setting: $\pm 0.2\%$ of maximum frequency (at $25 \pm 10^\circ\text{C}$) Digital setting: $\pm 0.01\%$ of maximum frequency (at -10 to $+50^\circ\text{C}$)
	Setting resolution	Analog setting: $1/1000$ of maximum frequency (e.g. 0.06 Hz at 60 Hz, 0.4 Hz at 400 Hz) (Includes the built-in potentiometer on the keypad.) Keypad setting: 0.01 Hz (99.99 Hz or less), 0.1 Hz (100.0 Hz or more) (Setting with \wedge , \vee keys.) Link setting: Selectable from 2 types <ul style="list-style-type: none"> • $1/20000$ of maximum frequency (e.g. 0.003 Hz at 60 Hz, 0.02 Hz at 400 Hz) • 0.01 Hz (fixed)
	Control method	V/f control (Simplified torque-vector control)
	Voltage/frequency characteristics	<ul style="list-style-type: none"> • Possible to set output voltage at base frequency and at maximum frequency (common specifications). Three-phase 200 V, single-phase 200 V, single-phase 100 V: 80 to 240 V Three-phase 400 V: 160 to 500 V • AVR control can be turned ON or OFF (Factory setting: OFF).
(Non-linear V/f pattern)	1 point (Desired voltage and frequency can be set.)	
Torque boost	Torque boost can be set with the function code F09. (Sets when 0, 1, 3, or 4 is selected at F37.)	
(Load selection)	Select application load type with the function code F37. <ol style="list-style-type: none"> 0: Variable torque load increasing in proportion to the square of speed 1: Constant torque load 2: Auto-torque boost 3: Auto-energy saving operation (Variable torque load increasing in proportion to the square of speed in acceleration/deceleration) 4: Auto-energy saving operation (Constant torque load in acceleration/deceleration) 5: Auto-energy saving operation (Auto-torque boost in acceleration/deceleration) 	
Control	Starting torque	150% or more (Automatic torque boost in 5 Hz operation)
	Start/stop	Keypad operation: Start (forward/reverse) and stop with RUN and STOP keys External signal (5 digital inputs): FWD, REV, coast-to-stop command, etc. Link operation: Communication via RS-485 (RS-485 communications functions are optional.)
	Frequency setting	Can be set with built-in potentiometer (standard) Can be set with \wedge or \vee key (Remote keypad (available soon) is also usable.) Can be set with external potentiometer (1 to 5 k Ω) <ul style="list-style-type: none"> • Connected to analog input terminals 13, 12, and 11. • Potentiometer must be provided.
	Analog input	<ul style="list-style-type: none"> • Can be set with external voltage/current input • 0 to +10 VDC (0 to +5 VDC)/0 to 100 % (terminal 12) • +4 to +20 mA DC/0 to 100 % (terminal C1)
	(Inverse mode operation)	<ul style="list-style-type: none"> • Can be reversed with digital input signal (IVS) • +10 to 0 VDC (+5 to 0 VDC)/0 to 100 % (terminal 12) • +20 to +4 mA DC/0 to 100 % (terminal C1)
	Multi-step frequency:	Selectable from 8 steps (step 0 to 7)
	Link operation:	Can be set with communication via RS-485 (RS-485 communications functions are optional.)

Item	Detail specifications																						
Control	Running status signal	Transistor output (1 point) : RUN, FAR, FDT, LU, etc. Relay output (1 point) : Alarm relay output or multi-purpose relay output signal Analog output (1 point) : Output frequency, output current, output voltage, input power, etc.																					
	Acceleration/ deceleration time	0.00 to 3600 s * If 0.00 s is set, the time setting is cancelled and acceleration and deceleration is made according to the pattern given with an external signal.																					
	(Pattern)	Acceleration and deceleration time can be independently set and selected with digital input signal (1 point). Acceleration and deceleration pattern can be selected from 4 types: Linear, S-curve (weak), S-curve (strong), Curvilinear																					
	Various functions	Frequency limiter (peak and bottom limiters), Bias frequency, Gain for frequency command, Jump frequency control, Jogging operation, Timer operation, Auto-restart after instantaneous power failure, Slip compensation, Current limit, PID control, Automatic deceleration, Overload prevention control, Energy saving operation, Fan stop operation																					
Indication	Running	• Speed monitor, output current (A), output voltage (V), input power (kW), PID process command, PID feedback amount, Timer (s) • Select the speed monitor to be displayed from the following: • Output frequency (before slip compensation) (Hz), output frequency (after slip compensation) (Hz), set frequency (Hz), load shaft speed (rpm), line speed (m/min), constant rate of feeding time (min). * Speed monitor can display the speed set at E48.																					
	Stopping	Displays the same contents as displayed during running.																					
	Alarm mode	Displays the cause of trip by codes as follows. <table border="0"> <tr> <td>$\overline{OL}1$: Overcurrent during acceleration</td> <td>$\overline{OL}2$: Overcurrent during deceleration</td> </tr> <tr> <td>$\overline{OL}3$: Overcurrent during running at constant speed</td> <td>\overline{LPH} : Input phase loss</td> </tr> <tr> <td>\overline{UV} : Undervoltage</td> <td>\overline{OPL} : Output phase loss</td> </tr> <tr> <td>$\overline{OU}1$: Overvoltage during acceleration</td> <td>$\overline{OU}2$: Overvoltage during deceleration</td> </tr> <tr> <td>$\overline{OU}3$: Overvoltage during running at constant speed</td> <td>$\overline{OH}1$: Overheating of the heat sink</td> </tr> <tr> <td>\overline{HTR} : External thermal relay tripped</td> <td>\overline{MPT} : Motor protection (PTC thermistor)</td> </tr> <tr> <td>\overline{DBH} : Overheating of the DB circuit</td> <td>\overline{MOV} : Motor overload</td> </tr> <tr> <td>\overline{IUU} : Inverter unit overload</td> <td>\overline{MEM} : Memory error</td> </tr> <tr> <td>\overline{Erc} : Remote keypad communications error</td> <td>\overline{CPU} : CPU error</td> </tr> <tr> <td>\overline{Erb} : Operation procedure error</td> <td>$\overline{RS485}$: RS-485 communication error</td> </tr> <tr> <td>\overline{Erf} : Data save error due to undervoltage</td> <td></td> </tr> </table> For details, refer to Section 8.6 "Protective Functions."	$\overline{OL}1$: Overcurrent during acceleration	$\overline{OL}2$: Overcurrent during deceleration	$\overline{OL}3$: Overcurrent during running at constant speed	\overline{LPH} : Input phase loss	\overline{UV} : Undervoltage	\overline{OPL} : Output phase loss	$\overline{OU}1$: Overvoltage during acceleration	$\overline{OU}2$: Overvoltage during deceleration	$\overline{OU}3$: Overvoltage during running at constant speed	$\overline{OH}1$: Overheating of the heat sink	\overline{HTR} : External thermal relay tripped	\overline{MPT} : Motor protection (PTC thermistor)	\overline{DBH} : Overheating of the DB circuit	\overline{MOV} : Motor overload	\overline{IUU} : Inverter unit overload	\overline{MEM} : Memory error	\overline{Erc} : Remote keypad communications error	\overline{CPU} : CPU error	\overline{Erb} : Operation procedure error	$\overline{RS485}$: RS-485 communication error	\overline{Erf} : Data save error due to undervoltage
$\overline{OL}1$: Overcurrent during acceleration	$\overline{OL}2$: Overcurrent during deceleration																						
$\overline{OL}3$: Overcurrent during running at constant speed	\overline{LPH} : Input phase loss																						
\overline{UV} : Undervoltage	\overline{OPL} : Output phase loss																						
$\overline{OU}1$: Overvoltage during acceleration	$\overline{OU}2$: Overvoltage during deceleration																						
$\overline{OU}3$: Overvoltage during running at constant speed	$\overline{OH}1$: Overheating of the heat sink																						
\overline{HTR} : External thermal relay tripped	\overline{MPT} : Motor protection (PTC thermistor)																						
\overline{DBH} : Overheating of the DB circuit	\overline{MOV} : Motor overload																						
\overline{IUU} : Inverter unit overload	\overline{MEM} : Memory error																						
\overline{Erc} : Remote keypad communications error	\overline{CPU} : CPU error																						
\overline{Erb} : Operation procedure error	$\overline{RS485}$: RS-485 communication error																						
\overline{Erf} : Data save error due to undervoltage																							
Running or alarm mode	Alarm history: Saves and displays the last 4 trip codes and their detailed description. (Even with the main power off, the alarm history data of the last 4 trips are retained.)																						
Environment Protection	Refer to Section 8.6 "Protective Functions."																						
	Refer to Chapter 1, Section 1.4 "Storage Environment" and Chapter 2, Section 2.1 "Operating Environment."																						

8.4 Terminal Specifications

8.4.1 Terminal functions

For details about the main and control circuit terminals, refer to Chapter 2, Section 2.3.5 and Section 2.3.7 (Table 2.8), respectively.

8.4.2 Connection diagram in operation by external signal inputs

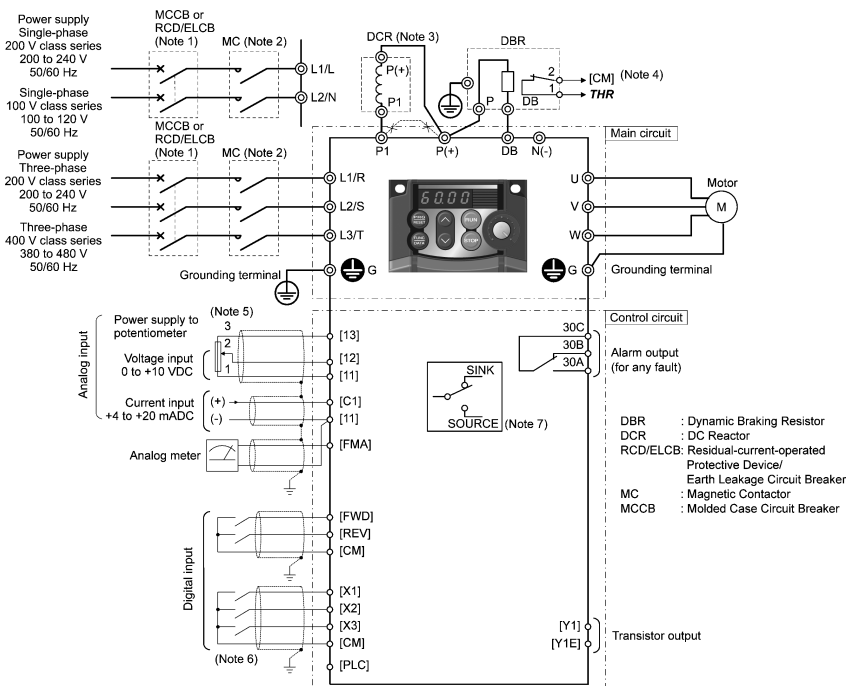

(Note 1) Install a recommended molded case circuit breaker (MCCB) or a residual-current-operated protective device (RCD)/earth leakage circuit breaker (ELCB) (with overcurrent protection) in the input (primary) circuit of the inverter to protect wiring. At this time, ensure that the circuit breaker capacity is equivalent to or lower than the recommended capacity.

(Note 2) A magnetic contactor (MC) should, if necessary, be mounted independent of the MCCB or ELCB to cut off the power fed to the inverter. Refer to page 9-2 for details. MCs or solenoids that will be installed close to the inverter require surge absorbers to be connected in parallel to their coils.

(Note 3) For an inverter connected to the power supply of 500 kVA or more (50 kVA or more for single-phase 100 V class series), be sure to connect an optional DC reactor (DCR).
When connecting a DCR to the inverter, remove the jumper bar from terminals [P1] and [P+].
Note that the terminal assignment of single-phase 100 V class series of inverters differs that of the above diagram. For details about the terminal assignment, refer to Chapter 10 (page 10-1).

(Note 4) **THR** function can be used by assigning code "9" (Enable external alarm trip) to any of terminals [X1] to [X3], [FWD] or [REV] (function code E01 to E03, E98, or E99). For details, refer to Chapter 5.

- (Note 5) Frequency can be set by connecting a frequency setting device (external potentiometer) between the terminals [11], [12], and [13] instead of inputting voltage signal (0 to +10 VDC or 0 to +5 VDC) between the terminals [12] and [11].
- (Note 6) For the wiring of the control circuit, use shielded or twisted wires. When using shielded wires, connect the shields to earth. To prevent malfunction due to noise, keep the control circuit wiring away from the main circuit wiring as far as possible (recommended: 10 cm or longer), and never set them in the same wire duct. When crossing the control circuit wiring with the main circuit wiring, set them at right angles.
- (Note 7) In the EU version except the three-phase 200 V class series of inverters, the digital input terminals are switched to the SOURCE side.

8.5 External Dimensions

8.5.1 Standard models and models available on order (braking resistor built-in type)

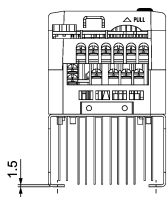
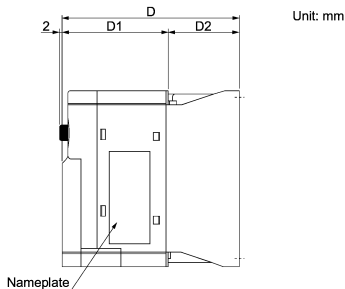
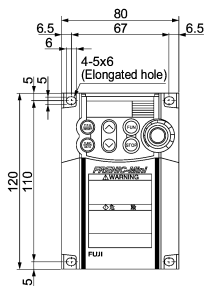

Power supply voltage	Inverter type	Dimensions (mm)		
		D	D1	D2
Three-phase 200 V	FRN0.1C1S-2□**	80	70	10
	FRN0.2C1S-2□**	95		25
	FRN0.4C1S-2□**	120	70	50
	FRN0.75C1S-2□**	140		90
Single-phase 200 V	FRN0.1C1S-7□	80	70	10
	FRN0.2C1S-7□	95		25
	FRN0.4C1S-7□	140	90	50
Single-phase 100 V	FRN0.1C1S-6□	100	90	10
	FRN0.2C1S-6□	115		25
	FRN0.4C1S-6□			

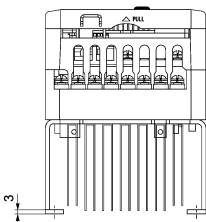
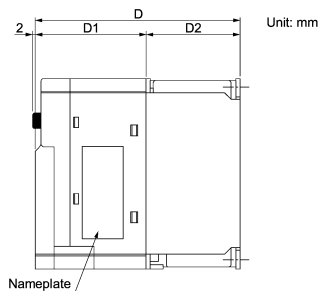
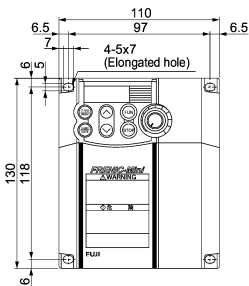

Power supply voltage	Inverter type	Dimensions (mm)		
		D	D1	D2
Three-phase 400 V	FRN0.4C1S-4□**	115	75	40
	FRN0.75C1S-4□**	139		64
Single-phase 100 V	FRN0.75C1S-6□	139	99	40

- Note
- 1) A box (□) in the above table replaces A, C, E, or J depending on the shipping destination.
 - 2) Asterisks (**) in the above table replace numbers which denote the following:
21: Braking resistor built-in type, None: Standard.

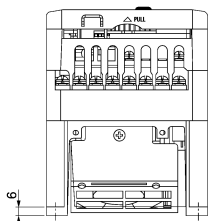
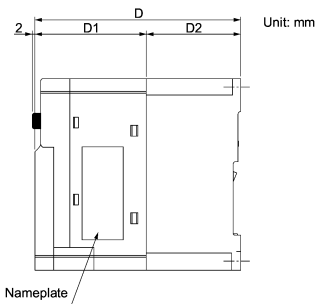
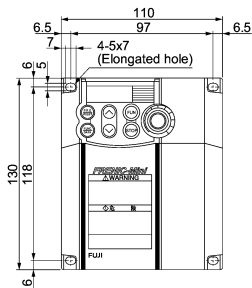

Power supply voltage	Inverter type	Dimensions (mm)		
		D	D1	D2
Three-phase 200 V	FRN1.5C1S-2□**	139	75	64
	FRN2.2C1S-2□**			
Three-phase 400 V	FRN1.5C1S-4□**			
	FRN2.2C1S-4□**			
Single-phase 200 V	FRN1.5C1S-7□	149	85	

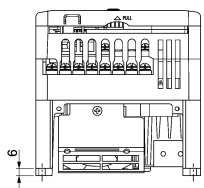
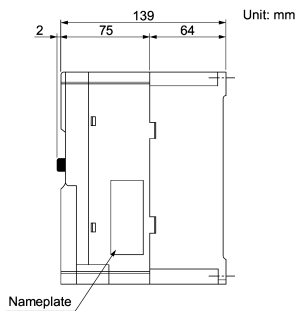
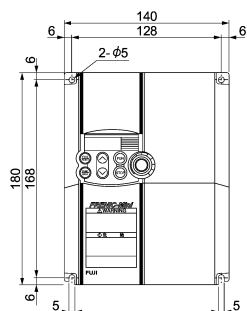

Power supply voltage	Inverter type
Three-phase 200 V	FRN3.7C1S-2□**
Three-phase 400 V	FRN3.7C1S-4□**
	FRN4.0C1S-4□**
Single-phase 200 V	FRN2.2C1S-7□

- Note 1) A box (□) in the above table replaces A, C, E, or J depending on the shipping destination.
 2) Asterisks (**) in the above table replace numbers which denote the following:
 21: Braking resistor built-in type, None: Standard.

8.5.2 Models available on order (EMC filter built-in type)

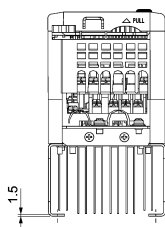
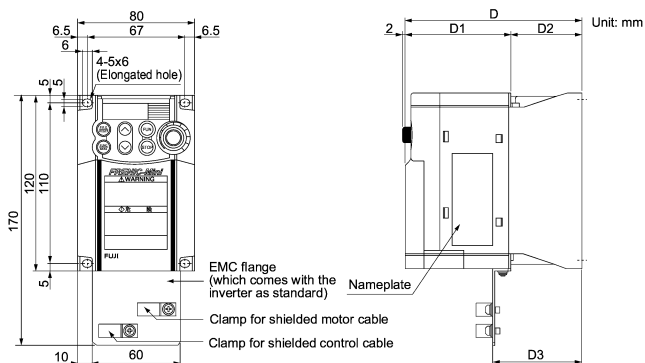

Power supply voltage	Inverter type	Dimensions (mm)			
		D	D1	D2	D3
Three-phase 200 V	FRN0.1C1E-2#	100	90	10	21.2
	FRN0.2C1E-2#			25	36.2
	FRN0.4C1E-2#	140	50	61.2	
	FRN0.75C1E-2#				
Single-phase 200 V	FRN0.1C1E-7#	100	90	10	21.2
	FRN0.2C1E-7#			25	36.2
	FRN0.4C1E-7#	115			

Note: # in the above table denotes the shipping destination as shown below.

Shipping destination (Version)/ Language in Instruction manual	Shipping destination code
Asia/English	A
China/Chinese	C
EU/ English	E
Japan/Japanese	J

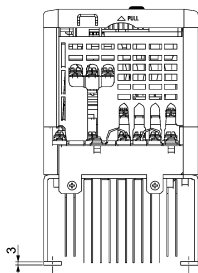
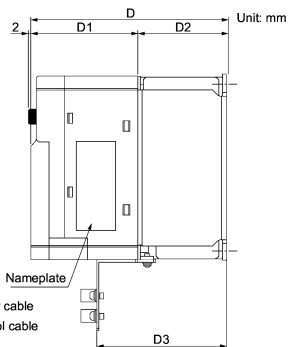
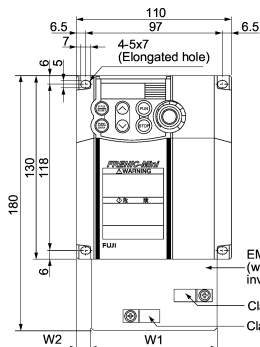

Power supply voltage	Inverter type	Dimensions (mm)					
		W1	W2	D	D1	D2	D3
Three-phase 400 V	FRN0.4C1E-4#	89	10.5	158	118	40	61.5
	FRN0.75C1E-4#			182		64	85.5
Single-phase 200 V	FRN0.75C1E-7#	60	13.0	139	99	40	55.2

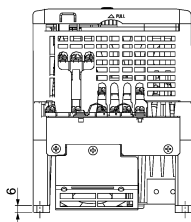
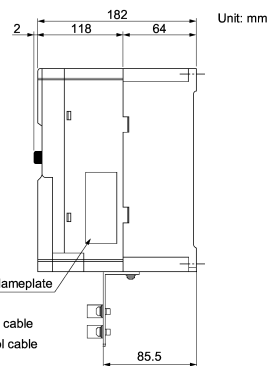
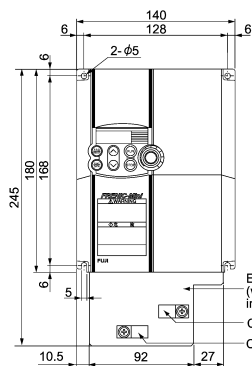



Power supply voltage	Inverter type
Three-phase 200 V	FRN1.5C1E-2#
	FRN2.2C1E-2#
	FRN3.7C1E-2#
Three-phase 400 V	FRN1.5C1E-4#
	FRN2.2C1E-4#
	FRN3.7C1E-4#
	FRN4.0C1E-4E
Single-phase 200 V	FRN1.5C1E-7#
	FRN2.2C1E-7#

8.6 Protective Functions

"—": Not applicable.

Name		Description	LED monitor displays	Alarm output [30A, B, C]	
Overcurrent protection		<ul style="list-style-type: none"> - Stops the inverter output to protect the inverter from an overcurrent resulting from overload. - Stops the inverter output to protect the inverter from an overcurrent due to a short circuit in the output circuit. - Stops the inverter output to protect the inverter from an overcurrent due to a ground fault in the output circuit. This protection is effective only when the inverter starts. If you turn on the inverter without removing the ground fault, this protection may not work. 	During acceleration	OL1	Yes
			During deceleration	OL2	
			During running at constant speed	OL3	
Overvoltage protection		<p>The inverter stops the inverter output upon detecting an overvoltage condition (400 VDC for three-phase 200 V, single-phase 200 V, and single-phase 100 V class series; 800 VDC for three-phase 400 V class series) in the DC link bus.</p> <p>This protection is not assured if excess AC line voltage is applied inadvertently.</p>	During acceleration	OU1	Yes
			During deceleration	OU2	
			During running at constant speed (Stopped)	OU3	
Undervoltage protection		<p>Stops the inverter output when the DC link bus voltage drops below the undervoltage level (200 VDC for three-phase 200 V, single-phase 200 V, and single-phase 100 V class series; 400 VDC for three-phase 400 V class series).</p> <p>However, if data "4 or 5" is selected for F14, no alarm is output even if the DC link bus voltage drops.</p>		LU	Yes (Note)
Input phase loss protection		<p>Detects input phase loss, stopping the inverter output. This function prevents the inverter from undergoing heavy stress that may be caused by input phase loss or inter-phase voltage unbalance and may damage the inverter.</p> <p>If connected load is light or a DC reactor is connected to the inverter, this function will not detect input phase loss if any.</p> <p>In single-phase series of inverters, this function is disabled by factory default.</p>		L17	Yes
Output phase loss protection		Detects breaks in inverter output wiring at the start of running and during running, stopping the inverter output.		OP1	Yes
Overheat protection	Inverter	- Stops the inverter output upon detecting excess heat sink temperature in case of cooling fan failure or overload.		OH1	Yes
	Braking resistor	<ul style="list-style-type: none"> - When the built-in or external braking resistor overheats, discharging and the operation of the inverter are stopped. * It is necessary to set the function code data according to the braking resistor used (built-in or external). 		OH	Yes
Overload protection		Stops the inverter output if the Insulated Gate Bipolar Transistor (IGBT) internal temperature calculated from the output current and cooling fan temperature detection is over the preset value.		OLU	Yes

(Note) No alarm output depending upon the data setting of the function code.

Name	Description	LED monitor displays	Alarm output [30A,B,C]
Motor protection	Electronic thermal overload relay In the following cases, the inverter stops running the motor to protect the motor in accordance with the electronic thermal function setting. - Protects general-purpose motors over the entire frequency range. - Protects inverter motors over the entire frequency range. * The operation level and thermal time constant can be set.	<i>OL 1</i>	Yes
	PTC thermistor A PTC thermistor input stops the inverter output for motor protection. A PTC thermistor is connected between terminals [C1] and [11], and a 1-kΩ external resistor is connected between terminals [13] and [C1].	<i>OH</i>	Yes
	Overload early warning Outputs a preliminary alarm at a preset level before the motor is stopped by the electronic thermal function for the purpose of protecting the motor.	—	—
Stall prevention	Operates when instantaneous overcurrent limiting is active. Instantaneous overcurrent limiting: Operates if the inverter's output current exceeds the instantaneous overcurrent limit level, avoiding tripping of the inverter (during constant speed operation or during acceleration).	—	—
External alarm input	Stops the inverter output with an alarm through the digital input signal THR .	<i>OH2</i>	Yes
Alarm relay output (for any fault)	The inverter outputs a relay contact signal when the inverter issues an alarm and stops the inverter output. < Alarm Reset > The alarm stop state is reset by pressing the  key or by the digital input signal RST . < Saving the alarm history and detailed data > The information on the previous 4 alarms can be saved and displayed.	—	Yes
Memory error	The inverter checks memory data after power-on and when the data is written. If a memory error is detected, the inverter stops.	<i>Er 1</i>	Yes
Remote keypad communications error	The inverter stops by detecting a communication error between the inverter and the remote keypad (option) during operation from the remote keypad.	<i>Er 2</i>	Yes
CPU error	If the inverter detects a CPU error caused by noise or some other factor, the inverter stops.	<i>Er 3</i>	Yes
Operation Protection	STOP key priority Pressing the  key on the keypad forces the inverter to decelerate and stop the motor even if the inverter is running by any run commands given via the terminals or communications (link operation). After the motor stops, the inverter issues alarm <i>Er 5</i> .	<i>Er 5</i>	Yes

Name	Description		LED monitor displays	Alarm output [30A,B,C]
Operation Protection	Start check function	Inverters prohibit any run operations and displays <i>E-r-E</i> on the LED of keypad if any run command is present when: <ul style="list-style-type: none"> - Powering up - An alarm ( key turned on) is released or an alarm reset <i>RST</i> is input. - Link command <i>LE</i> has switched inverter operation and the run command in the source to be switched is active. 	<i>E-r-E</i>	Yes
RS-485 communication error	On detecting an RS-485 communication error, the inverter displays the alarm code.		<i>E-r-B</i>	Yes
Data save error during undervoltage	If the data could not be saved during activation of the undervoltage protection function, the inverter displays the alarm code.		<i>E-r-F</i>	Yes
Overload prevention control	In the event of overheating of the cooling fan or an overload condition (alarm display: <i>OH 1</i> or <i>OLU</i>), the output frequency of the inverter is reduced to keep the inverter from tripping.		—	—

Chapter 9 LIST OF PERIPHERAL EQUIPMENT AND OPTIONS

The table below lists the main peripheral equipment and options that are connected to the FRENIC-Mini. Use them in accordance with your system requirements.

 For details, refer to the FRENIC-Mini User's Manual (MEH446), Chapter 6 "SELECTING PERIPHERAL EQUIPMENT."

	Name of peripheral equipment	Function and application																																																																																						
Main peripheral equipment	Molded case circuit breaker (MCCB) Residual-current-operated protective device (RCD) /Earth leakage circuit breaker (ELCB)* * with overcurrent protection	<p>MCCBs are designed to protect the power circuits between the power control board and inverter's main terminals (L1/R, L2/S and L3/T for three-phase power, L1/L and L2/N for single-phase power) from overload or short-circuit which in turn prevents secondary disasters caused by the inverter malfunctioning.</p> <p>RCDs/ELCBs function in the same way as MCCBs. Use the MCCBs and RCDs/ELCBs that satisfy the recommended rated current listed below.</p> <table border="1" data-bbox="308 487 847 1142"> <thead> <tr> <th rowspan="2">Power supply voltage</th> <th rowspan="2">Applicable motor rating (kW)</th> <th rowspan="2">Inverter type</th> <th colspan="2">Recommended rated current (A) of MCCB and RCD/ELCB</th> </tr> <tr> <th>w/ DC reactor</th> <th>w/o DC reactor</th> </tr> </thead> <tbody> <tr> <td rowspan="6">Three-phase 200 V</td> <td>0.1</td> <td>FRN0.1C1■-2□</td> <td rowspan="3">5</td> <td rowspan="3">5</td> </tr> <tr> <td>0.2</td> <td>FRN0.2C1■-2□</td> </tr> <tr> <td>0.4</td> <td>FRN0.4C1■-2□</td> </tr> <tr> <td>0.75</td> <td>FRN0.75C1■-2□</td> <td rowspan="3">10</td> <td>10</td> </tr> <tr> <td>1.5</td> <td>FRN1.5C1■-2□**</td> <td>15</td> </tr> <tr> <td>2.2</td> <td>FRN2.2C1■-2□**</td> <td>20</td> </tr> <tr> <td rowspan="6">Three-phase 400 V</td> <td>3.7</td> <td>FRN3.7C1■-2□**</td> <td>20</td> <td>30</td> </tr> <tr> <td>0.4</td> <td>FRN0.4C1■-4□</td> <td rowspan="3">5</td> <td rowspan="3">5</td> </tr> <tr> <td>0.75</td> <td>FRN0.75C1■-4□</td> </tr> <tr> <td>1.5</td> <td>FRN1.5C1■-4□**</td> </tr> <tr> <td>2.2</td> <td>FRN2.2C1■-4□**</td> <td rowspan="3">10</td> <td>10</td> </tr> <tr> <td>3.7</td> <td>FRN3.7C1■-4□**</td> <td>15</td> </tr> <tr> <td>4.0</td> <td>FRN4.0C1■-4□**</td> <td>20</td> </tr> <tr> <td rowspan="6">Single-phase 200 V</td> <td>0.1</td> <td>FRN0.1C1■-7□</td> <td rowspan="3">5</td> <td rowspan="3">5</td> </tr> <tr> <td>0.2</td> <td>FRN0.2C1■-7□</td> </tr> <tr> <td>0.4</td> <td>FRN0.4C1■-7□</td> </tr> <tr> <td>0.75</td> <td>FRN0.75C1■-7□</td> <td>10</td> <td>15</td> </tr> <tr> <td>1.5</td> <td>FRN1.5C1■-7□</td> <td>15</td> <td>20</td> </tr> <tr> <td>2.2</td> <td>FRN2.2C1■-7□</td> <td>20</td> <td>30</td> </tr> <tr> <td rowspan="4">Single-phase 100 V</td> <td>0.1</td> <td>FRN0.1C1■-6□</td> <td rowspan="2">5</td> <td>5</td> </tr> <tr> <td>0.2</td> <td>FRN0.2C1■-6□</td> <td>10</td> </tr> <tr> <td>0.4</td> <td>FRN0.4C1■-6□</td> <td>10</td> <td>15</td> </tr> <tr> <td>0.75</td> <td>FRN0.75C1■-6□</td> <td>15</td> <td>20</td> </tr> </tbody> </table> <p>Note 1) A box (■) in the above table replaces S or E depending on the enclosure. 2) A box (□) in the above table replaces A, C, E, or J depending on the shipping destination. 3) Asterisks (**) in the model names replace numbers which denote the following: 21: Braking resistor built-in type, None: Standard</p> <p>Select the MCCB or RCD/ELCB with appropriate breaking capacity according to the power supply capacity.</p>	Power supply voltage	Applicable motor rating (kW)	Inverter type	Recommended rated current (A) of MCCB and RCD/ELCB		w/ DC reactor	w/o DC reactor	Three-phase 200 V	0.1	FRN0.1C1■-2□	5	5	0.2	FRN0.2C1■-2□	0.4	FRN0.4C1■-2□	0.75	FRN0.75C1■-2□	10	10	1.5	FRN1.5C1■-2□**	15	2.2	FRN2.2C1■-2□**	20	Three-phase 400 V	3.7	FRN3.7C1■-2□**	20	30	0.4	FRN0.4C1■-4□	5	5	0.75	FRN0.75C1■-4□	1.5	FRN1.5C1■-4□**	2.2	FRN2.2C1■-4□**	10	10	3.7	FRN3.7C1■-4□**	15	4.0	FRN4.0C1■-4□**	20	Single-phase 200 V	0.1	FRN0.1C1■-7□	5	5	0.2	FRN0.2C1■-7□	0.4	FRN0.4C1■-7□	0.75	FRN0.75C1■-7□	10	15	1.5	FRN1.5C1■-7□	15	20	2.2	FRN2.2C1■-7□	20	30	Single-phase 100 V	0.1	FRN0.1C1■-6□	5	5	0.2	FRN0.2C1■-6□	10	0.4	FRN0.4C1■-6□	10	15	0.75	FRN0.75C1■-6□	15	20
	Power supply voltage	Applicable motor rating (kW)				Inverter type	Recommended rated current (A) of MCCB and RCD/ELCB																																																																																	
			w/ DC reactor	w/o DC reactor																																																																																				
	Three-phase 200 V	0.1	FRN0.1C1■-2□	5	5																																																																																			
		0.2	FRN0.2C1■-2□																																																																																					
		0.4	FRN0.4C1■-2□																																																																																					
		0.75	FRN0.75C1■-2□	10	10																																																																																			
		1.5	FRN1.5C1■-2□**		15																																																																																			
		2.2	FRN2.2C1■-2□**		20																																																																																			
	Three-phase 400 V	3.7	FRN3.7C1■-2□**	20	30																																																																																			
		0.4	FRN0.4C1■-4□	5	5																																																																																			
		0.75	FRN0.75C1■-4□																																																																																					
		1.5	FRN1.5C1■-4□**																																																																																					
		2.2	FRN2.2C1■-4□**	10	10																																																																																			
		3.7	FRN3.7C1■-4□**		15																																																																																			
	4.0	FRN4.0C1■-4□**	20																																																																																					
	Single-phase 200 V	0.1	FRN0.1C1■-7□	5	5																																																																																			
		0.2	FRN0.2C1■-7□																																																																																					
		0.4	FRN0.4C1■-7□																																																																																					
		0.75	FRN0.75C1■-7□	10	15																																																																																			
1.5		FRN1.5C1■-7□	15	20																																																																																				
2.2		FRN2.2C1■-7□	20	30																																																																																				
Single-phase 100 V	0.1	FRN0.1C1■-6□	5	5																																																																																				
	0.2	FRN0.2C1■-6□		10																																																																																				
	0.4	FRN0.4C1■-6□	10	15																																																																																				
	0.75	FRN0.75C1■-6□	15	20																																																																																				

	Name of peripheral equipment	Function and application
Main peripheral equipment	Molded case circuit breaker Earth leakage circuit breaker* * with overcurrent protection	<div style="border: 1px solid black; padding: 5px;"> <p style="text-align: center;">⚠ WARNING</p> <p>When connecting the inverter to the power supply, add a recommended molded case circuit breaker and earth leakage circuit breaker* in the path of power supply. Do not use the devices with the rated current out of the recommended range.</p> <p>*With overcurrent protection</p> <p>Fire could occur.</p> </div>
	Magnetic contactor (MC)	<p>An MC can be used at both the power input (primary) and output (secondary) sides of the inverter. At each side, the MC works as described below. When inserted in the output circuit of the inverter, an MC can also switch the motor drive power source between the inverter output and commercial power lines.</p> <p>■ At the power source (primary) side</p> <p>Insert an MC in the power source side of the inverter in order to:</p> <ol style="list-style-type: none"> 1) Forcibly cut off the inverter from the power source (generally, commercial/factory power lines) with the protection function built into the inverter, or with the terminal signal line. 2) Stop the inverter operation in an emergency when the inverter cannot interpret the stop command due to internal/external circuit failures. 3) Cut off the inverter from the power source when the MCCB inserted in the power source side cannot cut it off for maintenance or inspection purpose. If you are to use the MC for this purpose only, it is recommended that you use an MC capable of turning the MC on/off manually. <p>Note: When your system requires the motor(s) driven by the inverter to be started/stopped with the MC, the frequency of the starting/stopping operation should be once or less per hour. The more frequent the operation, the shorter operation life of the MC and capacitor/s used in the DC link bus due to thermal fatigue caused by the frequent charging of the current flow. If this is not necessary, start/stop the motor with the terminal commands FWD, REV and/or HLD, or with the keypad.</p> <p>■ At the output (secondary) side</p> <p>Prevent externally turned-around current from being applied to the inverter power output terminals (U, V, and W) unexpectedly. An MC should be used, for example, if a circuit that switches the motor driving source between the inverter output and commercial/factory power lines is connected to the inverter.</p> <p>Note: As application of high voltage external current to the inverter's secondary (output) circuits may break the IGBTs, MCs should be used in the power control system circuits to switch the motor drive power source to the commercial/factory power lines after the motor has come to a complete stop. Also ensure that voltage is never mistakenly applied to the inverter output terminals due to unexpected timer operation, or similar.</p> <p>■ Driving the motor using commercial power lines</p> <p>MCs can also be used to switch the power source of the motor driven by the inverter to a commercial power source.</p>

	Name of option	Function and application
Main option	Braking resistors (Standard model) (DBRs)	A braking resistor converts regenerative energy generated from deceleration of the motor and converts it to heat for consumption. Use of a braking resistor results in improved deceleration performance of the inverter.
	DC reactors (DCRs)	<p>A DCR is mainly used for power supply normalization and for supplied power-factor reformation (for reducing harmonic components).</p> <p>1) For power supply normalization</p> <ul style="list-style-type: none"> - When connecting the inverter to the power supply of 500 kVA or more (50 kVA or more for single-phase 100 V class series), use an optional DC reactor (DCR). <p>Otherwise, the percentage-reactance of the power source decreases, and harmonic components and their peak levels increase. These factors may break rectifiers or capacitors in the converter section of inverter, or decrease the capacitance of the capacitor (which can shorten the inverter's service life).</p> <ul style="list-style-type: none"> - Also use a DCR when there are thyristor-driven loads or when condensive capacitors are being turned on/off. <p>2) For supplied power-factor reformation (harmonic component reduction)</p> <p>Generally a capacitor is used to reform the power factor of the load, however, it cannot be used in a system that includes an inverter. Using a DCR increases the reactance of inverter's power source so as to decrease harmonic components on the power source lines and reform the power factor of inverter. Using a DCR reforms the input power factor to approximately 90 to 95%.</p> <p>Note: At the time of shipping, a jumper bar is connected across the terminals P1 and P (+) on the terminal block. Remove the jumper bar when connecting a DCR.</p>
	Output circuit filters (OFLs)	<p>Include an OFL in the inverter power output circuit to:</p> <p>1) Suppress the voltage fluctuation at the motor input terminals</p> <p>This protects the motor from insulation damage caused by the application of high voltage surge currents by the 400 V class of inverters.</p> <p>2) Suppress leakage current from the power output (secondary) lines (due to harmonic components)</p> <p>This reduces the leakage current when the motor is hooked by long power feed lines. It is recommended that the length of the power feed line be kept to less than 400 m.</p> <p>3) Minimize emission and/or induction noise issued from the power output (secondary) lines</p> <p>OFLs are effective in reducing noise from long power feed lines, such as those used in plants, etc.</p> <p>Note: Use an OFL within the allowable carrier frequency range specified by function code F26 (Motor sound (carrier frequency)). Otherwise, the filter will overheat.</p>
	EMC-compliant filter	A special filter for making the inverter compliant with Europe's EMC directives.

	Name of option	Function and application
Main option	Ferrite ring reactors for reducing radio frequency noise (ACL)	An ACL is used to reduce radio noise emitted by the inverter. An ACL suppresses the outflow of high frequency harmonics caused by switching operation for the power supply (primary) lines inside the inverter. Pass the power supply lines together through the ACL for 4 turns (coiled 3 times). If wiring length between the inverter and motor is less than 20 m, insert an ACL to the power supply (primary) lines; if it is more than 20 m, insert it to the power output (secondary) lines of the inverter.
	Options for 100V single-phase power supply	An optional single-phase 100 V power supply may be used to operate an inverter designed for a three-phase 200 V power supply with single-phase 100 V power.
Options for Operation and Communications	External potentiometer for frequency commands	An external potentiometer may be used to set the drive frequency. Connect the potentiometer to control signal terminals [11] to [13] of the inverter.
	Remote keypad	This allows you to perform remote operation of the inverter. (You need an extension cable and RS-485 communications card to connect the remote keypad to the inverter.) With the remote keypad, you may copy function code data set in the inverter to any other inverter.
	Extension cable for remote operation	The extension cable connects the RS-485 communications card with a remote keypad or a USB-RS-485 converter. Three lengths are available: 5 m, 3 m and 1 m
	RS-485 communications card	This makes communication to a PLC or personal computer system easy.
	Copy adapter	Used to copy data into multiple inverters.
	Connector adapter	A spare connector for the copy adapter.
	USB-RS-485 converter	A converter that allows connection of an RS-485 communications card to a USB port on a PC.
	Inverter loader software	Windows-based inverter loader software that makes function code setting easy. The RS-485 communications card must be connected.
Other peripheral equipment	Surge absorbers	A surge absorber suppresses surge currents and noise from the power lines to ensure effective protection of your power system from the malfunctioning of the magnetic contactors, mini-relays and timers.
	Surge killers	A surge killer eliminates surge currents induced by lightning and noise from the power supply lines. Use of a surge killer is effective in preventing the electronic equipment, including inverters, from damage or malfunctioning caused by such surges and/or noise.
	Arresters	An arrester suppresses surge currents and noise invaded from the power supply lines. Use of an arrester is effective in preventing electronic equipment, including inverters, from damage or malfunctioning caused by such surges and/or noise.
	Frequency meter	Displays the frequency in accordance with signal output from the inverter.

	Name of option	Function and application
Other options	Mounting adapters	FRENIC-Mini series of inverters can be installed to the control board of your system using mounting adapters which utilize the mounting holes used for conventional inverters (FVR-E11S series of 0.75 kW or below or 3.7 kW). The FVR-E11S-2/4 (1.5 kW/2.2 kW) and FVR-E11S-7 (0.75 kW/1.5 kW) series may be replaced with any of the FRENIC-Mini series of inverters without the use of adapters.
	Rail mounting bases	A rail mounting base allows any of the FRENIC-Mini series of inverters to be mounted on a DIN rail (35 mm wide).
	NEMA1 kit	Installing the NEMA1 kit to the inverter lets the inverter have the NEMA1-compliant (UL TYPE1 certified) protective enclosure.

Chapter 10 APPLICATION OF DC REACTORS (DCRs)

Since the "Japanese Guideline for Suppressing Harmonics in Home and General-purpose Appliances" issued by the Ministry of International Trade and Industry (Currently the Ministry of Economy, Trade and Industry) was revised in January 2004, the general-purpose inverters have no longer been subject to the guideline. Individual inverter manufacturers have voluntarily employed harmonics suppression measures. It is recommended that DC reactors (DCRs) specified in Table 10.1 be connected to the FRENIC-Mini series of inverters.

Table 10.1 List of DC Reactors (DCRs)

Power supply voltage	Nominal applied motor (kW)	Applicable inverter type	DCR type	For connection Refer to:
Three-phase 200 V	0.1	FRN0.1C1■-2□	DCR2-0.2	Figure 10.1 (1)
	0.2	FRN0.2C1■-2□		
	0.4	FRN0.4C1■-2□	DCR2-0.4	
	0.75	FRN0.75C1■-2□	DCR2-0.75	
	1.5	FRN1.5C1■-2□**	DCR2-1.5	
	2.2	FRN2.2C1■-2□**	DCR2-2.2	
Single-phase 200 V	0.1	FRN0.1C1■-7□	DCR2-0.2	Figure 10.1 (1)
	0.2	FRN0.2C1■-7□	DCR2-0.4	
	0.4	FRN0.4C1■-7□	DCR2-0.75	
	0.75	FRN0.75C1■-7□	DCR2-1.5	
	1.5	FRN1.5C1■-7□	DCR2-2.2	
	2.2	FRN2.2C1■-7□	DCR2-3.7	
Single-phase 100 V	0.1	FRN0.1C1■-6□	DCR2-0.75	Figure 10.1 (2)
	0.2	FRN0.2C1■-6□	DCR2-1.5	
	0.4	FRN0.4C1■-6□	DCR2-2.2	
	0.75	FRN0.75C1■-6□	DCR2-3.7	

Note 1) A box (■) in the above table replaces S or E depending on the enclosure.

2) A box (□) in the above table replaces A, C, E, or J depending on the shipping destination.

3) Asterisks (***) in the above table replace numbers which denote the following:

21: Braking resistor built-in type, None: Standard models.

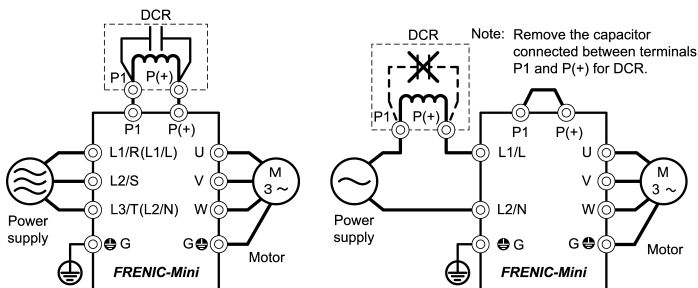

(1) For three-phase 200 V or single-phase 200 V

(2) For single-phase 100 V

Figure 10.1 Connection Diagram of DC Reactor (DCR)

Chapter 11 COMPLIANCE WITH STANDARDS

11.1 Compliance with UL Standards and Canadian Standards (cUL certification)

11.1.1 General

Originally, the UL standards were established by Underwriters Laboratories, Inc. as private criteria for inspections/investigations pertaining to fire/accident insurance in the USA. Later, these standards were authorized as the official standards to protect operators, service personnel and the general populace from fires and other accidents in the USA.

cUL certification means that UL has given certification for products to clear CSA Standards. cUL certified products are equivalent to those compliant with CSA Standards.

11.1.2 Considerations when using FRENIC-Mini in systems to be certified by UL and cUL

If you want to use the FRENIC-Mini series of inverters as a part of UL Standards or CSA Standards (cUL certified) certified product, refer to the related guidelines described on page ix.

11.2 Compliance with European Standards

The CE marking on Fuji products indicates that they comply with the essential requirements of the Electromagnetic Compatibility (EMC) Directive 89/336/EEC issued by the Council of the European Communities and Low Voltage Directive 73/23/EEC.

Only the EMC filter built-in type of inverters that bear a CE marking are compliant with these EMC Directives.

Inverters that bear a CE marking or TÜV mark are compliant with the Low Voltage Directive.

The products comply with the following standards:

Low Voltage Directive	EN50178:	1997
EMC Directives	EN61800-3:	1996+A11 : 2000
	EN55011:	1998+A : 1999
	Immunity:	Second environment (EN61800-3+A11 Industrial)
	Emission:	Class 1A (EN55011+A1) (Applicable only to the EMC filter built-in type of inverters)
	:	Second environment (EN61800-3 + A11 Industrial) (Applicable only when an optional EMC-compliant filter is attached)

CAUTION

The FRENIC-Mini series of inverters are categorized as a "restricted sales distribution class" of the EN61800-3. When you use these products with any home appliances or office equipment, you may need to take appropriate countermeasures to reduce or eliminate any noise emitted from these products.

11.3 Compliance with EMC Standards

11.3.1 General

The CE marking on inverters does not ensure that the entire equipment including our CE-marked products is compliant with the EMC Directive. Therefore, CE marking for the equipment shall be the responsibility of the equipment manufacturer. For this reason, Fuji's CE mark is indicated under the condition that the product shall be used within equipment meeting all requirements for the relevant Directives. Instrumentation of such equipment shall be the responsibility of the equipment manufacturer.

Generally, machinery or equipment includes not only our products but other devices as well. Manufacturers, therefore, shall design the whole system to be compliant with the relevant Directives.

In addition, to satisfy the requirements noted above, use a Fuji FRENIC inverter in connection with an EMC-compliant filter (optional feature) or an EMC filter built-in type inverter in accordance with the instructions contained in this instruction manual. Installing the inverter(s) in a metal panel may be necessary, depending upon the operating environment of the equipment that the inverter is to be used with.

Tip Our EMC compliance test is performed under the following conditions.

- Motor Sound (carrier frequency) (F26): 15 kHz
- Wiring length (of the shielded cable) between the inverter and motor: 10 m

11.3.2 Recommended installation procedure

To make the machinery or equipment fully compliant with the EMC Directive, have certified technicians wire the motor and inverter in strict accordance with the procedure described below.

■ In the case of EMC filter built-in type of inverters

- (1) Mount the EMC grounding flange (that comes with the inverter) to the inverter with screws in order to ground the wire shield(s). (See Figure 11.1.)

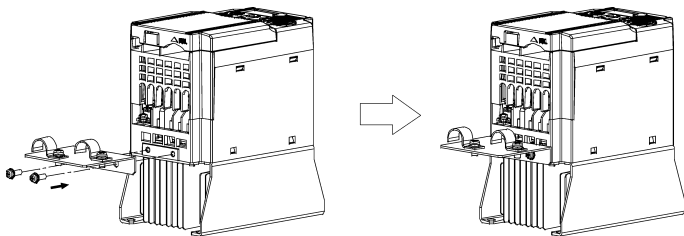

Figure 11.1 Attaching the EMC Grounding Flange

- (2) Use shielded wires for the motor cable and route it as short as possible. Firmly clamp the wire shield to the flange to ground it. Further, connect the wire shield electrically to the grounding terminal of motor. (See Figure 11.2.)

- (3) Use shielded wires for the control signals of the inverter to input to/output from the control terminals. Firmly clamp the control wire shields to the EMC grounding flange (in the same way as the motor cables).

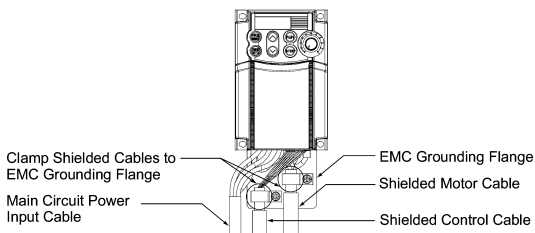

Figure 11.2 Connecting Shielded Cables

<When an RS-485 Communications Card (optional) is used>

Use a shielded cable for connection. Strip the cable of the cable sheath so that the shield is exposed, as shown at right. Then connect the shield wire firmly to the shield grounding clamp so that it is grounded.

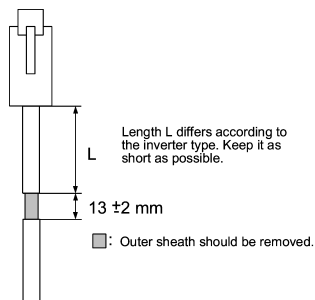

Figure 11.3 Preparing End of Extension Cable or LAN Cable for Connection

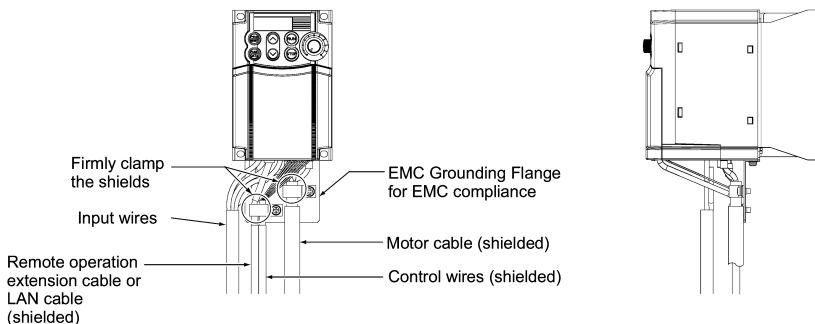

Figure 11.4 Connecting Shield Wire for Compliance with EMC Directive

- (4) If noise from the inverter exceeds the permissible level, enclose the inverter and its peripherals within a metal panel as shown in Figure 11.5.

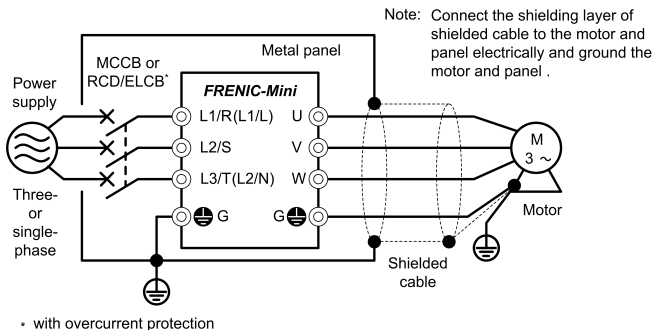

Figure 11.5 Installing the Inverter into a Metal Panel

■ In case an outboard, EMC-compliant (optional) is used

- 1) Install the inverter and the filter on a grounded metal plate. Use a shielded cable also for connection of the motor. Make the cables as short as possible. Connect the shield wire firmly to the metal plate. Also connect the shield wire electrically to the grounding terminal of the motor.
- 2) Use shielded wire for connection around the control terminals of the inverter and also for connection of the signal cable of an RS-485 Communications Card. As with the motor, clamp the shield wire firmly to a grounded plate.
- 3) If noise from the inverter exceeds the permissible level, enclose the inverter and its peripherals within a metal panel as shown in Figure 11.6.

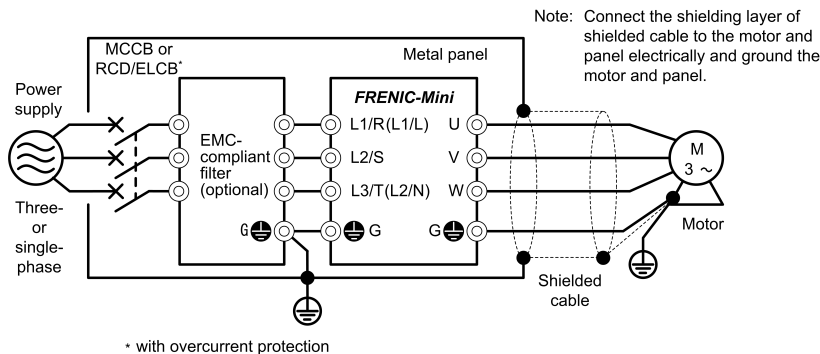

Figure 11.6 Installing the Inverter with EMC-compliant filter into a Metal Panel

11.3.3 Leakage current of EMC-filter built-in type inverter and outboard EMC-complaint filter

Table 11.1 Leakage current of EMC filter built-in type inverter

Input Power	Inverter type *1)	Leakage current (mA) *2), *3)	
		Normal	Worst
Three-phase 200V	FRN0.1C1E-2□	7.5	7.5
	FRN0.2C1E-2□		
	FRN0.4C1E-2□		
	FRN0.75C1E-2□	13.0	20.0
	FRN1.5C1E-2□**		
	FRN2.2C1E-2□**		
FRN3.7C1E-2□**			
Three-phase 400V	FRN0.4C1E-4□	5.4	33.0
	FRN0.75C1E-4□		
	FRN1.5C1E-4□**	3.8	25.0
	FRN2.2C1E-4□**		
	FRN3.7C1E-4□**		
	FRN4.0C1E-4□**		
Single-phase 200V	FRN0.1C1E-7□	8.3	8.3
	FRN0.2C1E-7□		
	FRN0.4C1E-7□		
	FRN0.75C1E-7□	4.1	8.2
	FRN1.5C1E-7□		
	FRN2.2C1E-7□		

*1) - A box (□) in the above table replaces A, C, E, or J depending on the shipping destination.

- Asterisks (**) in the above table denote the following:

21: Braking resistor built-in type, None: Standard

*2) The values are calculated assuming the power supplies of three-phase 240 V (50 Hz), three-phase 400 V (50 Hz), and single-phase 230 V (50 Hz).

*3) The worst condition includes a phase loss in the supply line.

Table 11.2 Leakage current of EMC-compliant filter (optional)

Input power	Inverter type*1)	Filter type	Leakage current (mA) *2), *3)	
			Normal	Worst
Three-phase 200V	FRN0.1C1S-2□	FS5956-6-46 (EFL-0.75E11-2)	3.0	3.0
	FRN0.2C1S-2□			
	FRN0.4C1S-2□			
	FRN0.75C1S-2□			
	FRN1.5C1S-2□**	FS5956-26-47 (EFL-4.0E11-2)	3.0	3.0
	FRN2.2C1S-2□**			
	FRN3.7C1S-2□**			
Three-phase 400V	FRN0.4C1S-4□	15TDHS84 (Delta Electronics, Inc.)	4.0	27.0
	FRN0.75C1S-4□			
	FRN1.5C1S-4□**			
	FRN2.2C1S-4□**			
	FRN3.7C1S-4□**			
	FRN4.0C1S-4□**			
Single-phase 200V	FRN0.1C1S-7□	30DKCS5 (Delta Electronics, Inc.)	1.0	1.8
	FRN0.2C1S-7□			
	FRN0.4C1S-7□			
	FRN0.75C1S-7□			
	FRN1.5C1S-7□			
	FRN2.2C1S-7□			

*1) - A box (□) in the above table replaces A, C, E, or J depending on the shipping destination.

- Asterisks (**) in the above table denote the following:

21: Braking resistor built-in type, None: Standard

*2) The values are calculated assuming the power supplies of three-phase 240 V (50 Hz), three-phase 400 V (50 Hz), and single-phase 230 V (50 Hz).

*3) The worst condition includes a phase loss in the supply line.

11.4 Harmonic Component Regulation in the EU

11.4.1 General comments

When you use general-purpose industrial inverters in the EU, the harmonics emitted from the inverter to power lines are strictly regulated as stated below.

If an inverter whose rated input is 1 kW or less is connected to public low-voltage power supply, it is regulated by the harmonics emission regulations from inverters to power lines (with the exception of industrial low-voltage power lines). Refer to Figure 11.7 below for details.

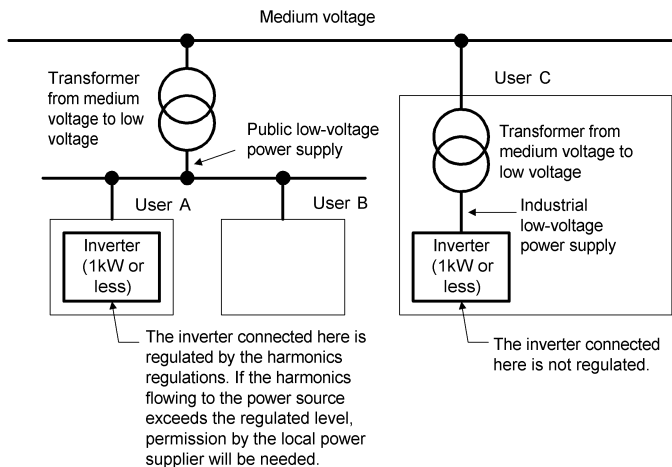

Figure 11.7 Power Source and Regulation

11.4.2 Compliance with the harmonic component regulation

Table 11.3 Compliance with Harmonic Component Regulation

Power supply voltage	Inverter type	w/o DC reactor	w/ DC reactor	Applicable DC reactor type
Three-phase 200 V	FRN0.1C1■-2□	√*	√*	DCR2-0.2
	FRN0.2C1■-2□	√*	√*	DCR2-0.2
	FRN0.4C1■-2□	√*	√*	DCR2-0.4
	FRN0.75C1■-2□	√*	√*	DCR2-0.75
Three-phase 400 V	FRN0.4C1■-4□	—	√	DCR4-0.4
	FRN0.75C1■-4□	—	√	DCR4-0.75
Single-phase 200 V	FRN0.1C1■-7□	—	√	DCR2-0.2
	FRN0.2C1■-7□	—	√	DCR2-0.4
	FRN0.4C1■-7□	—	√	DCR2-0.75
	FRN0.75C1■-7□	—	—	DCR2-1.5

* Inverter types marked with √ in the table above are compliant with the EN61000-3-2 (+A14), so they may be connected to public low-voltage power supply unconditionally. Conditions apply when connecting models marked with "—". If you want to connect them to public low-voltage power supply, you need to obtain permission from the local electric power supplier. In general, you will need to provide the supplier with the harmonics current data of the inverter. To obtain the data, contact your Fuji Electric representative.

Note 1) A box (■) in the above table replaces S or E depending on the enclosure.

A box (□) in the above table replaces A, C, E, or J depending on the shipping destination.

- 2) When supplying three-phase 200 VAC power stepped down from a three-phase 400 VAC power line using a transformer, the level of harmonic flow from the 400 VAC line will be regulated.

11.5 Compliance with the Low Voltage Directive in the EU

11.5.1 General

General-purpose inverters are regulated by the Low Voltage Directive in the EU. Fuji Electric has obtained the proper certification for the Low Voltage Directive from the official inspection agency. Fuji Electric states that all our inverters with CE and/or TÜV marking are compliant with the Low Voltage Directive.

11.5.2 Points for consideration when using the FRENIC-Mini series in a system to be certified by the Low Voltage Directive in the EU

If you want to use the FRENIC-Mini series of inverters in systems/equipment in the EU, refer to the guidelines on page vii.

MEMO

MEMO

MEMO

Compact Inverter
FRENIC-Mini

Instruction manual

First Edition, October 2002

Fourth Edition, February 2007

Fuji Electric FA Components & Systems Co., Ltd.

The purpose of this instruction manual is to provide accurate information in handling, setting up and operating of the FRENIC-Mini series of inverters. Please feel free to send your comments regarding any errors or omissions you may have found, or any suggestions you may have for generally improving the manual.

In no event will Fuji Electric FA Components & Systems Co., Ltd. be liable for any direct or indirect damages resulting from the application of the information in this manual.

Fuji Electric FA Components & Systems Co., Ltd.

Mitsui Sumitomo Bank Ningyo-cho Bldg., 5-7, Nihonbashi, Odemma-cho, Chuo-ku, Tokyo, 103-0011,
Japan

Phone: +81 3 5847 8011 Fax: +81 3 5847 8172

URL <http://www.fujielectric.co.jp/fcs/>
