



取扱説明書 / Instruction Manual

PROFIBUS-DP 通信カード  
PROFIBUS-DP Communications Card  
"OPC-PDP3"

日本語

ENGLISH

**English Version**

**ENGLISH**



## Preface

Thank you for purchasing our PROFIBUS-DP Communications Card OPC-PDP3.

This manual has been prepared to help you connect your Inverter to a PROFIBUS-DP master (Siemens PLC, computer, etc.) via PROFIBUS-DP.

Mounting the communications card on your inverter allows you to connect the inverter to a PROFIBUS-DP master node and control it as a slave unit using run and frequency commands, and access to function codes.

In the state that I attached OPC-PDP3 to,

It has the following features:

- PROFIBUS version: DP-V0 compliant
- Transmission speed: 9,600 bps to 12 Mbps
- Maximum network cable length per segment: 100 m (12 Mbps) to 1200 m (9.6 kbps)
- Applicable Profile: PROFIDrive V2 compliant
- Able to read and write all function codes supported in the inverter.

This manual does not provide information on the handling of inverters. Be sure to read and understand the Instruction Manual and User's Manual of the corresponding inverter as well as this manual in advance for the proper use of the product. Improper handling might result in incorrect operation, a short life, or even a failure of this product.

Keep this manual in a safe place.

### Related Publications

Listed below are the other materials related to the use of the PROFIBUS-DP Communications Card OPC-PDP3. Read them in conjunction with this manual as necessary.

- RS-485 Communication User's Manual
- Inverter Instruction Manual
- Inverter User's Manual
- PROFIBUS Communications Card "OPC-PDP3" Adaptable Inverters

The materials are subject to change without notice. Be sure to obtain the latest editions for use.

Information provided in this manual, including information on the figures, presence or absence of terminals, function codes, and alarm codes, may vary with each inverter.

## CAUTION



- Read through this instruction manual and be familiar with the PROFIBUS-DP communications card before proceeding with installation, connections (wiring), operation, or maintenance and inspection.
- Improper handling might result in incorrect operation, a short life, or even a failure of this product as well as the motor.
- Deliver this manual to the end user of this product. Keep this manual in a safe place until this product is discarded.

ENGLISH

## ■ Safety precautions



Read this manual thoroughly before proceeding with installation, connections (wiring), operation, or maintenance and inspection. Ensure you have sound knowledge of the device and familiarize yourself with all safety information and precautions before proceeding to operate the inverter.

Safety precautions are classified into the following two categories in this manual.

 <b>WARNING</b>	Failure to heed the information indicated by this symbol may lead to dangerous conditions, possibly resulting in death or serious bodily injuries.
 <b>CAUTION</b>	Failure to heed the information indicated by this symbol may lead to dangerous conditions, possibly resulting in minor or light bodily injuries and/or substantial property damage.



Failure to heed the information contained under the CAUTION title can also result in serious consequences. These safety precautions are of utmost importance and must be observed at all times.

### Installation and wiring

 <b>WARNING</b> 	
<ul style="list-style-type: none"><li>• Before starting the work, turn the inverter OFF and wait for the period specified in the Instruction Manual of the corresponding inverter. Make sure that the LED lamps on the keypad are turned OFF. Then use a multimeter or a similar instrument and check that the DC intermediate circuit voltage between the terminals P(+) and N(-) has dropped to a safe voltage level (+25 VDC or below).</li><li>• Qualified electricians should carry out wiring. <b>Otherwise, an electric shock could occur.</b></li></ul>	

 <b>CAUTION</b>	
<ul style="list-style-type: none"><li>• Do not use the product that is damaged or lacking parts. <b>Doing so could cause a fire, an accident, or injuries.</b></li><li>• Prevent lint, paper fibers, sawdust, dust, metallic chips, or other foreign materials from getting into the inverter and the communications card. <b>Otherwise, a fire or an accident might result.</b></li><li>• Incorrect handling in installation/removal jobs could cause a failure. <b>A failure might result.</b></li><li>• Noise may be emitted from the inverter, motor and wires. Implement appropriate measure to prevent the nearby sensors and devices from malfunctioning due to such noise. <b>Otherwise, an accident could occur.</b></li></ul>	

### Operation

 <b>WARNING</b> 	
<ul style="list-style-type: none"><li>• Be sure to install the front cover before turning the inverter's power ON. Do not remove the cover when the inverter power is ON. <b>Otherwise, an electric shock could occur.</b></li><li>• Do not operate switches with wet hands. <b>Doing so could cause an electric shock.</b></li><li>• If you configure the function codes wrongly or without completely understanding Instruction Manual and the User's Manual, the motor may rotate with a torque or at a speed not permitted for the machine. Confirm and adjust the setting of the function codes before running the inverter. <b>Otherwise, an accident could occur.</b></li></ul>	

### Maintenance and inspection, and parts replacement

#### **WARNING**

- Before starting the work, turn the inverter OFF and wait for the period specified in the Instruction Manual of the corresponding inverter. Make sure that the LED lamps on the keypad are turned OFF. Then use a multimeter or a similar instrument and check that the DC intermediate circuit voltage between the terminals P(+) and N(-) has dropped to a safe voltage level (+25 VDC or below).  
**Otherwise, an electric shock could occur.**
- Maintenance, inspection, and parts replacement should be made only by qualified persons.
- Take off the watch, rings and other metallic objects before starting work.
- Use insulated tools.  
**Otherwise, an electric shock or injuries could occur.**

### Disposal

#### **CAUTION**

- Treat the communications card as an industrial waste when disposing of it.  
**Otherwise injuries could occur.**

### Others

#### **WARNING**

- Never modify the communications card.  
**Doing so could cause an electric shock or injuries.**

ENGLISH

### Icons

The following icons are used throughout this manual.



This icon indicates information which, if not heeded, can result in the product not operating to full efficiency, as well as information concerning incorrect operations and settings which can result in accidents.



This icon indicates information that can prove handy when performing certain settings or operations.



This icon indicates a reference to more detailed information.

## Table of Contents

<p>Preface ..... 1</p> <p>■ Safety precautions..... 2</p> <p>Chapter 1 BEFORE USE..... 5</p> <p>    1.1 Acceptance Inspection ..... 5</p> <p>    1.2 Adaptable Inverters ..... 5</p> <p>Chapter 2 NAMES AND FUNCTIONS..... 6</p> <p>    2.1 External Appearance ..... 6</p> <p>    2.2 Terminal Block (TERM1) ..... 6</p> <p>    2.3 Terminating Resistor Switch (SW3) ..... 7</p> <p>    2.4 Node Address Switches ..... 7</p> <p>    2.5 Setting the Transmission Speed (Baud Rate)..... 8</p> <p>    2.6 LED Status Indicators ..... 8</p> <p>Chapter 3 INSTALLATION..... 9</p> <p>Chapter 4 WIRING AND CABLING ..... 10</p> <p>    4.1 Basic Connection Diagram ..... 10</p> <p>    4.2 Wiring for PROFIBUS Terminal Block..... 11</p> <p>Chapter 5 CONFIGURING INVERTER'S FUNCTION CODES FOR PROFIBUS COMMUNICATION 12</p> <p>Chapter 6 ESTABLISHING A PROFIBUS COMMUNICATIONS LINK..... 14</p>	<p>Chapter 7 QUICK SETUP GUIDE FOR RUNNING THE INVERTER ..... 15</p> <p>    7.1 Before Proceeding to Data Exchange..... 15</p> <p>    7.2 Data Transaction Examples         in Running an Inverter ..... 15</p> <p>Chapter 8 DETAILS OF PROFIBUS PROFILES..... 18</p> <p>    8.1 Description of PPO Types Supported ..... 18</p> <p>    8.2 PCD Word Area ..... 20</p> <p>    8.3 PCV Word Area ..... 25</p> <p>Chapter 9 ERROR PROCESSING FOR PROFIBUS NETWORK BREAKS ..... 32</p> <p>Chapter 10 PROCESSING TO BE APPLIED UPON RECEIPT OF ALL-ZERO DATA ..... 33</p> <p>Chapter 11 LIST OF INVERTER ALARM CODES..... 34</p> <p>Chapter 12 TROUBLESHOOTING ..... 35</p> <p>Chapter 13 SPECIFICATIONS..... 36</p> <p>    13.1 General Specifications ..... 36</p> <p>    13.2 PROFIBUS-DP Specifications ..... 36</p>
--	--

## Chapter 1 BEFORE USE

### 1.1 Acceptance Inspection

Unpack the package and check the following:

- (1) A communications card, two screws (M3 × 8), and the PROFIBUS-DP Communications Card Instruction Manual (this document) are contained in the package.
- (2) The communications card is not damaged during transportation--no defective parts, dents or warps.
- (3) The model name "OPC-PDP3" is printed on the communications card. (See Figure 1.1.)

If you suspect the product is not working properly or if you have any questions about your product, contact the shop where you bought the product or your local Fuji branch office.

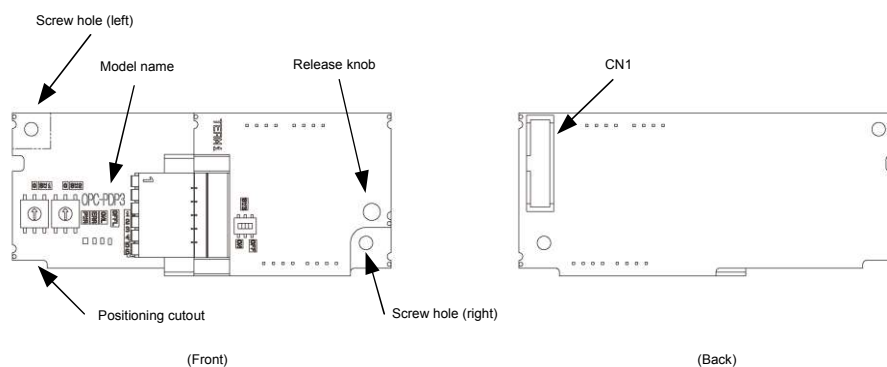

Figure 1.1 Names of Parts on PROFIBUS-DP Communications Card (OPC-PDP3)

### 1.2 Adaptable Inverters

Refer to the following instruction manual for inverters capable of using this communications card.

- PROFIBUS Communications Card "OPC-PDP3" Adaptable Inverters: INR-SI47-1890-JE



## Chapter 2 NAMES AND FUNCTIONS

### 2.1 External Appearance

The external appearance and the components of the PROFIBUS-DP communications card are shown in Figure 2.1 and Table 2.1, respectively.

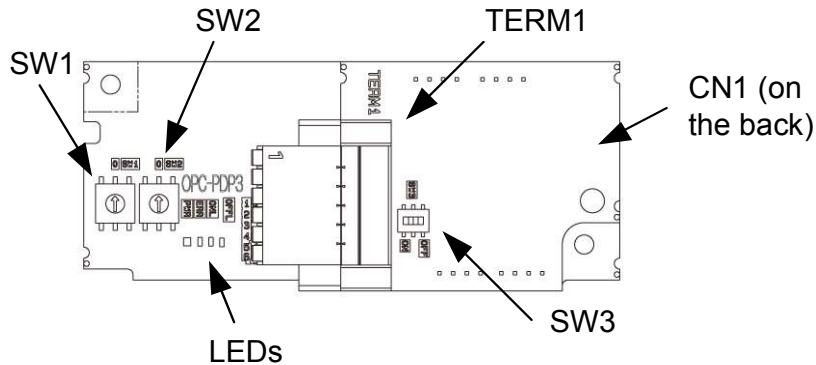

Figure 2.1 External View and Component Names

Table 2.1 Components on the PROFIBUS-DP Communications Card

Item	Description
TERM1	PROFIBUS-DP terminal block (3.5 mm pitch) (See Section 2.2.)
CN1	Connector for joint with inverter
SW1, SW2	Node address switches (Rotary switches) (See Section 2.4.)
SW3	Terminating resistor ON/OFF switch (See Section 2.3.)
LEDs	LED status indicators (PWR, ERR, ONL and OFFL) (See Section 2.6.)

### 2.2 Terminal Block (TERM1)

The terminal block TERM1 uses a pluggable, six-pin terminal block with the pin arrangement show in Table 2.2. Table 2.2 lists the pin assignment. A typical connector that matches this terminal block is Phoenix Contact TFMC1.5/6-STF-3.5. (Figure 2.2)

For details about the TFMC1.5/6-STF-3.5, visit the Phoenix Contact website at: <http://www.phoenixcontact.com/>

For wiring to the TERM1, refer to Section 4.2 "(3) Wiring to the PROFIBUS terminal block (TERM1)."

Table 2.2 Pin Assignment on the PROFIBUS Terminal Block

Pin #	Pin Assignment	Description
1	Shield	Terminal for connecting the cable shield
2	GND / CNTR-N	NC / Data transmission control signal (negative) for the repeater
3	+5V	NC
4	A-Line	Terminal for the negative (-) line of PROFIBUS cable (green wire)
5	B-Line	Terminal for the positive (+) line (red wire)
6	CNTR-P	Data transmission control signal (positive) for the repeater (direction control)

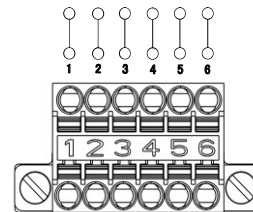

Figure 2.2 PROFIBUS-DP Terminal Block

### 2.3 Terminating Resistor Switch (SW3)

The PROFIBUS-DP communications network requires insertion of line terminating resistors at its both ends. When the communications card is mounted on the inverter at either end of the network, turn this switch ON to insert the terminating resistor.

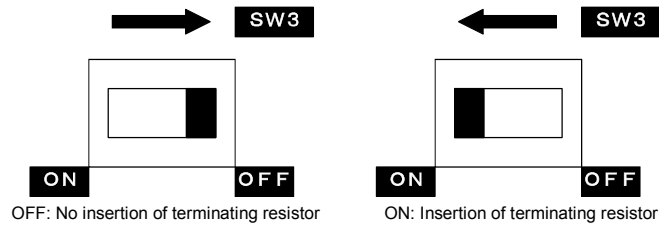

Figure 2.3 Terminating Resistor Switch Settings

### 2.4 Node Address Switches

The node address switches (SW1 and SW2) on the communications card are rotary ones that are used to specify the PROFIBUS-DP communications network node address (station address) of the communications card. The setting range is from 0 to 99 in decimal. The SW1 specifies a 10s digit of the node address and the SW2, a 1s digit.

The node address can also be specified with the inverter's function code o31. The setting range is from 0 to 125 in decimal.

Example 1: Setting the node address 27 using the node address switches

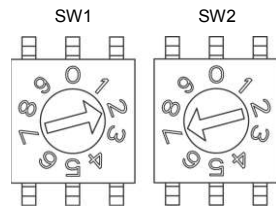

Figure 2.4 Node Address Setting Example 1

1. When the inverter is powered OFF:  
Set SW1 to "2."  
Set SW2 to "7."
2. Turn the inverter ON to complete the setting procedure.

Example 2: Setting the node address 125 using the function code

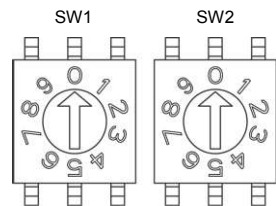

Figure 2.5 Node Address Setting Example 2

1. When the inverter is powered OFF:  
Set both the SW1 and SW2 to "0."
2. Turn the inverter ON and set the function code o31 data for node address setting to "125."
3. Restart the inverter to complete the setting procedure.



1. The node address switches should be accessed with the inverter being OFF. Setting these switches with the inverter being ON requires restarting it to enable the new settings.
2. To reflect the node address setting using the function code o31, restart the inverter.
3. Setting the function code o31 data to "126" or greater will cause an error, blinking the ERR LED on the communications card in red and issuing the alarm code  $E-5$  from the inverter. \*

\* The  $E-5$  does not occur when  $y98 = 0$  (Run/frequency command sources: Inverter) or  $o27 = 3, 13, 14,$  or  $15$  (Error processing after detection of PROFIBUS network break: Keep the current operation, ignoring the communications error). For details, refer to Chapter 9 "ERROR PROCESSING FOR PROFIBUS NETWORK BREAKS."

ENGLISH

## 2.5 Setting the Transmission Speed (Baud Rate)

No transmission speed setting is required on the communications card (slave). Setting the transmission speed in the PROFIBUS-DP network master node automatically configures the transmission speed of the communications card.

 The communications card supports the following transmission speeds.  
9.6, 19.2, 45.45, 93.75, 187.5, and 500 kbps  
1.5, 3, 6, and 12 Mbps

## 2.6 LED Status Indicators

The communications card has four LED status indicators shown in Figure 2.6. They indicate the operation status of the communications card as listed in Table 2.3.



Figure 2.6 LED Status Indicators

Table 2.3 LED Indications and Operation Status

Name	LED state	Meaning	Note
PWR	Lights in green	During normal operation	---
	Blinks in green	Initialization in progress during powering on sequence	This test takes approx. 0.5 second.
	Lights in red	Hardware error (Communications card not properly mounted or faulty)	The inverter shows $E-4$ .
	Blinks in red	PROFIBUS communications error	The inverter shows $E-5$ . *1
	OFF	No power supplied.	---
ERR	Blinks in red	Wrong configuration of PROFIBUS protocol (Discrepancy between PPO type defined by the inverter's function code o30 and the one defined in the PROFIBUS master node)*2	Flashing at 1 Hz
		Wrong configuration of PROFIBUS protocol (Error during initialization of PROFIBUS communication ASIC.)	Flashing at 4 Hz
		Wrong configuration of PROFIBUS protocol (The node address is set to 126 or greater.)	The inverter shows $E-5$ . *1
	OFF	No diagnostic result.	---
ONL	Lights in green	Online (The communications card communicates normally on the PROFIBUS network.)	---
	OFF	Not online	---
OFFL	Lights in red	Offline (The communications card is not connected to PROFIBUS)	---
	OFF	Not offline	---

\*1 Configuration for ignoring  $E-5$  (Option error) is possible. For details, refer to Chapter 9 "ERROR PROCESSING FOR PROFIBUS NETWORK BREAKS."

\*2 PPO (Parameter Process-data Object) type defined in the communications card should be consistent with that in the PROFIBUS-DP master node. To define the PPO type in the communications card, use the inverter's function code o30; to define that in the master node, use a configuration tool designed for the master node.

 For defining the PPO type in the master node, refer to the documentation of the master node.

 For details about the PPO type, see Chapter 8, "DETAILS OF PROFIBUS-DP PROFILES." For details about the function code o30, see Chapter 5 "CONFIGURING INVERTER'S FUNCTION CODES FOR PROFIBUS-DP COMMUNICATION."

ENGLISH

### Chapter 3 INSTALLATION

⚠ WARNING ⚠
<p>Before starting the work, turn the inverter OFF and wait for the period specified in the Instruction Manual of the corresponding inverter. Make sure that the LED lamps on the keypad are turned OFF. Then use a multimeter or a similar instrument and check that the DC intermediate circuit voltage between the terminals P(+) and N(-) has dropped to a safe voltage level (+25 VDC or below).</p> <p><b>Otherwise, an electric shock could occur.</b></p>

 The installation method varies with each Inverter. Refer to the "3. Installation Method" in the option attachment instruction manual in "PROFIBUS Communications Card "OPC-PDP3" Adaptable Inverters (INR-SI47-1890-JE)" and install the communications card.

 **Note** Before mounting the communications card, perform the wiring for the main circuit terminals and control circuit terminals.

## Chapter 4 WIRING AND CABLING

### ⚠ WARNING ⚠

- Before starting the work, turn the inverter OFF and wait for the period specified in the Instruction Manual of the corresponding inverter. Make sure that the LED lamps on the keypad are turned OFF. Then use a multimeter or a similar instrument and check that the DC intermediate circuit voltage between the terminals P(+) and N(-) has dropped to a safe voltage level (+25 VDC or below).
- Qualified electricians should carry out wiring.  
**Otherwise, an electric shock could occur.**
- In general, the covers of the control signal wires are not specifically designed to withstand a high voltage (i.e., reinforced insulation is not applied). Therefore, if a control signal wire comes into direct contact with a live conductor of the main circuit, the insulation of the cover might break down, which would expose the signal wire to a high voltage of the main circuit. Make sure that the control signal wires will not come into contact with live conductors of the main circuit.  
**Failure to observe this precaution could cause an electric shock or an accident.**

### ⚠ CAUTION ⚠

Noise may be emitted from the inverter, motor and wires.  
Take appropriate measures to prevent the nearby sensors and devices from malfunctioning due to such noise.  
**An accident could occur.**

#### 4.1 Basic Connection Diagram

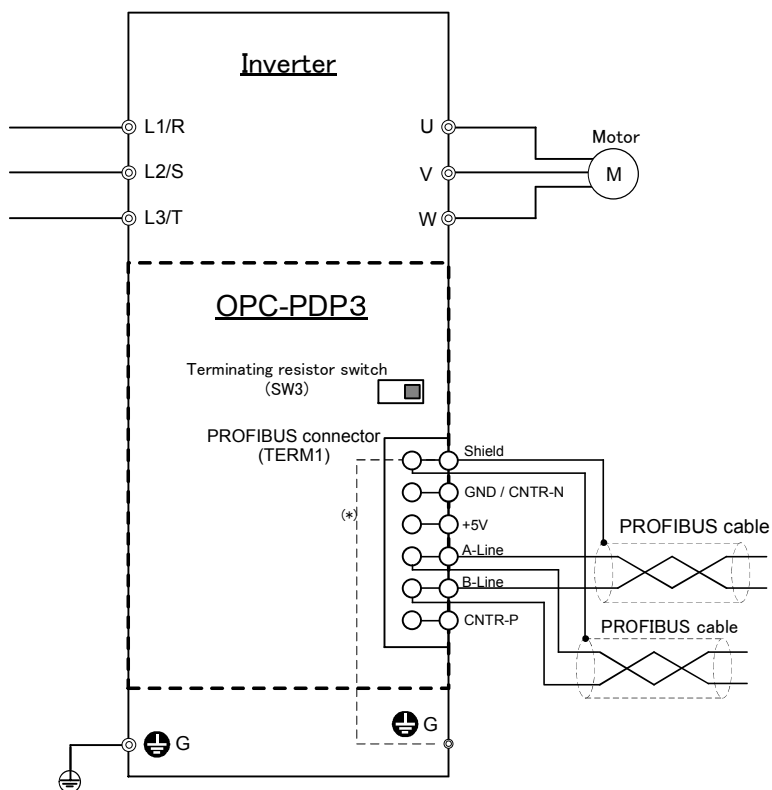

(\*) Mounting the communications card on the inverter forms this connection.

Figure 4.1 Connection Diagram

## 4.2 Wiring for PROFIBUS Terminal Block

Perform wiring for the communications card observing the precautions below. Refer to the connection diagram shown in Figure 4.2.

- (1) Turn the inverter's power OFF.
- (2) To connect the communications card to a PROFIBUS-DP network, use a shielded twist pair cable that complies with the PROFIBUS specifications.

**Tip** The recommended cable is a PROFIBUS FC standard cable 6XV1 830-0EH10 manufactured by Siemens AG.

**Note** For details about wiring for PROFIBUS, refer to the "Installation Guideline for PROFIBUS-DP/FMS" and "Handbook PROFIBUS Installation Guideline" published by the PROFIBUS Organization. It can be downloaded for free from the PROFIBUS Organization's website at:  
<http://www.profibus.com/pall/meta/downloads/>

- (3) Wiring to the PROFIBUS terminal block (TERM1)

- 1) Strip the wire end by 6 mm as shown below.

Applicable wire size	AWG24 to 16 (0.2 to 1.5 mm <sup>2</sup> )
Strip length of wire end	6 mm 
Type of screwdriver (tip shape)	Flat screwdriver, 0.4 x 2.5 mm

**Note** For strand wires, the strip length specified above should apply after twisting of them. Before connection to the terminal block, treat the end of the shield with a ferrule and apply insulation to the stripped section with an insulation tube again.  
 If the strip length is out of the specified range, the wire may not be firmly clamped or may be short-circuited with other wires.

- 2) Insert the end of the stripped wires into the wire inlet on the control circuit terminal. If the insertion is difficult, hold down the clamp release button on the terminal with a flat screwdriver.

- 3) When disconnecting the wires from the terminal, hold down the clamp release button on the terminal with a flat screwdriver and pull out the wires.

Connecting wires to terminal

Disconnecting wires from terminal

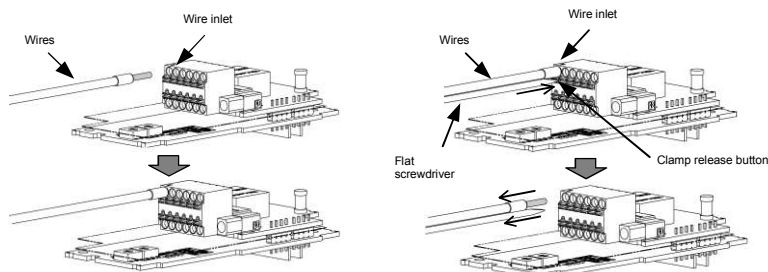

Figure 4.2 Connecting/Disconnecting Wires to/from the Terminal

**Note** To prevent malfunction due to noise, keep the wiring of the PROFIBUS cable away from the main circuit wiring, motor wiring, and other power lines as far as possible. Never install them in the same wire duct. Be sure to connect the shield wires.

- (4) Complete wiring before turning the inverter ON.

**Note**

- Route the wiring for the control circuit terminals as far from that for the main circuit terminals as possible. Otherwise electric noise may cause malfunctions.
- Fix the control circuit wires inside the inverter with a cable tie to keep them away from the live parts of the main circuit (such as main circuit terminal block).

**Note** Depending upon the wire type and the number of wires used, the front cover may be lifted by the wires, which impedes normal keypad operation. If it happens, change the wire type or size.

ENGLISH

## Chapter 5 CONFIGURING INVERTER'S FUNCTION CODES FOR PROFIBUS COMMUNICATION

To perform data transmission between the inverter equipped with the communications card and the PROFIBUS-DP master node, configure the function codes listed in Table 5.1.

For details about the inverter's function codes, refer to "User's Manual" for applicable inverter and the "RS-485 Communication User's Manual".

Table 5.1 Inverter's Function Code Settings Required for PROFIBUS Communication

Function codes	Description	Factory default	Function code data	Remarks															
o30 *1	Select PPO type (data format)	0	Select from the following: 0, 1, 6 to 255: PPO type 1 2 and 5: PPO type 2 3: PPO type 3 4: PPO type 4	The selected PPO type should be consistent with that of the master node.															
y98 *2	Select run/frequency command sources	0	Select from the following choices: <table border="1" style="margin-left: 20px;"> <thead> <tr> <th>y98</th> <th>Frequency command source</th> <th>Run command source</th> </tr> </thead> <tbody> <tr> <td>0</td> <td>Inverter</td> <td>Inverter</td> </tr> <tr> <td>1</td> <td>PROFIBUS</td> <td>Inverter</td> </tr> <tr> <td>2</td> <td>Inverter</td> <td>PROFIBUS</td> </tr> <tr> <td>3</td> <td>PROFIBUS</td> <td>PROFIBUS</td> </tr> </tbody> </table>	y98	Frequency command source	Run command source	0	Inverter	Inverter	1	PROFIBUS	Inverter	2	Inverter	PROFIBUS	3	PROFIBUS	PROFIBUS	If there is no special problem with your system, setting y98 = 3 is recommended.
y98	Frequency command source	Run command source																	
0	Inverter	Inverter																	
1	PROFIBUS	Inverter																	
2	Inverter	PROFIBUS																	
3	PROFIBUS	PROFIBUS																	

\*1 After configuring the function code o30, restart the inverter to enable the new settings. For details about the function code o30, refer to Chapter 8 "DETAILS OF PROFIBUS PROFILES."

\*2 In addition to y98, the inverters have other function codes related to the run/frequency command source. Configuring those codes realizes more precise selection of the command sources. For details, refer to sections H30 and y98 of the Instruction Manual and the User's Manual.

Table 5.2 Other Related Function Codes

Function codes	Description	Factory default	Setting range	Remarks
o27 *1	Select error processing for PROFIBUS network breaks.	0	0 to 15	
o28 *1	Set the operation timer to be used in error processing for network breaks.	0.0 s	0.0 to 60.0 s	
o31 *2	Set the PROFIBUS network node address.	0	0 to 255 (Effective range: 0 to 125)	Valid only when address switches SW1 and SW2 are set to "00." Setting 126 or greater causes an error, flashing the ERR LED and issuing an $E-5$ .
o32 *3	Select processing to be applied upon receipt of all-zero data	0	0 to 255 (Effective range: 0 to 2)	
o40 to o43 *4	Specify function codes for cyclical write.	0000 (No assignment)	0000 to FFFF (hex)	Valid only when PPO type 2 or 4 is selected.
o48 to o51 *4	Specify function codes for cyclical read.	0000 (No assignment)	0000 to FFFF (hex)	
y97	Communication data storage selection	0	0 to 2	*5,*6
W90	Show the software version of the PROFIBUS-DP communications card on the LED monitor.	Depends on the communications card	--- (Only for monitoring)	4-digit decimal If the version is V.1.23, the LED shows "123."

\*1 For details about function codes o27 and o28, refer to Chapter 9 "ERROR PROCESSING FOR PROFIBUS NETWORK BREAKS."

\*2 For details about function code o31, refer to Chapter 2, Section 2.4 "Node Address Switches."

\*3 For details about function code o32, refer to Chapter 10 "PROCESSING TO BE APPLIED UPON RECEIPT OF ALL-ZERO DATA."

\*4 For details about function codes o40 to o43 and o48 to o51, refer to Chapter 8, Section 8.2 (4) "PCD1 to PCD4."

- \*5 Do not turn OFF the inverter power while data is being saved. Turn OFF the power after 5 seconds or more have elapsed since starting to save data.
- \*6 The factory default is "0", and updated data is saved to nonvolatile memory. The number of times that data can be written to nonvolatile memory is limited, and therefore the setting value should be changed to "1" and the save destination used as volatile memory if updating data frequently. By doing so, data is deleted when the power is turned OFF. To save volatile memory data to nonvolatile memory, change the setting value to "2". After doing so, check the setting value, and if the value has returned to "1", data saving is complete.

 **Note** After configuring function codes o40 to o43 and o48 to o51, restart the inverter to enable the new settings.



## Chapter 6 ESTABLISHING A PROFIBUS COMMUNICATIONS LINK

This chapter guides you to establish a PROFIBUS-DP communications link between the PROFIBUS-DP master node and the communications card mounted on the inverter (slave node).

Follow the steps below.

- Step 1** Configuring the PROFIBUS-DP master node equipment
- Step 2** Configuring the communications card and inverter's function codes
- Step 3** Restarting the inverter ⇒ Initiating the PROFIBUS data transaction

Each of the above steps is detailed below.

### Step 1 Configuring the PROFIBUS-DP master node equipment

- Specify the master node address (station address) and baud rate.
- Register the communications card to the master node using the GSD file prepared for the communications card.
- Choose a PPO type (data format) to be applied to the registered option, from PPO type 1 to PPO type 4.

 For details about the configuration of the PROFIBUS-DP master node equipment, refer to the user's manual or documentations of your master equipment.

 For details about PPO types, refer to Chapter 8 "DETAILS OF PROFIBUS PROFILES."

#### IMPORTANT

A GSD file, which is required for registering the PROFIBUS-DP communications card to the PROFIBUS master node, does not come with the communications card. It is available as a free download from our website at:

<https://felib.fujielectric.co.jp/download/>

Before downloading, you are requested to register as a member (free of charge).

### Step 2 Configuring the communications card and inverter's function codes

- Specify the node address that must be identical with the communications card address registered to the master node.
- Configure the data of inverter function codes o27 and o28, if needed.
- Choose a PPO type from PPO type 1 to PPO type 4, using the inverter's function code o30.

The PPO type must be identical with the one selected for the master node. After changing the data of the function code o30, be sure to restart the inverter.

 For details about how to specify the node address, refer to Chapter 2 "NAMES AND FUNCTIONS."

 For details about function codes o27 and o28, refer to Chapter 9 "DETAILS OF PROFIBUS PROFILES."

### Step 3 Restarting the inverter ⇒ Initiating the PROFIBUS data transaction

When the inverter equipped with the communications card and the PROFIBUS-DP master node are properly configured and the wiring is correct, restarting the inverter automatically establishes a PROFIBUS communications link, enabling the data transaction between them. The PWR and ONL LEDs on the communications card light in green.

Send run and frequency commands from the master to the communications card.

 For specific data formats and data transaction, refer to Chapter 7 "QUICK SETUP GUIDE FOR RUNNING THE INVERTER" and Chapter 8 "DETAILS OF PROFIBUS PROFILES."

 For the wiring, refer to Chapter 4 "WIRING AND CABLING."



## Chapter 7 QUICK SETUP GUIDE FOR RUNNING THE INVERTER

This chapter provides a quick setup guide for running the inverter from a PROFIBUS-DP master node according to the simplest data format (PPO type 3), taking an operation example. PPO type 3 is a simple format dedicated to inverter's run and frequency commands.

 **Tip** The description of PPO type 3 in this chapter can apply to other PPO types, except the format assignment maps.

 To simplify the description, this chapter confines the description to running of an inverter. For more information, refer to Chapter 8 "DETAILS OF PROFIBUS PROFILES."

### 7.1 Before Proceeding to Data Exchange

- (1) At the PROFIBUS-DP master node, select PPO type 3 for the communications card.
  -  For the setting procedure of PPO types at the PROFIBUS-DP master node, refer to the user's manual of your master node equipment.
- (2) Set function codes of your inverter as follows.
  - F03 = 60 (Maximum frequency in Hz), y98 = 3 (Validate frequency and run commands from PROFIBUS), and o30 = 3 (Select PPO type 3)
  - Also set the data of function codes o27 and o28, if needed.
  - After settings are completed, restart the inverter to enable the new settings.
  -  For details about function codes o27 and o28, refer to Chapter 9 "ERROR PROCESSING FOR PROFIBUS NETWORK BREAKS."

### 7.2 Data Transaction Examples in Running an Inverter

Before providing data transaction examples, this section shows the data frame formats of PPO type 3. The following descriptions are based on these formats.

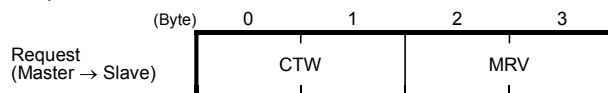

CTW: Control word (2 bytes) that sends a run command. The LSB determines ON/OFF of the run command.

MRV: Sends a frequency command that is expressed relative to the maximum frequency (defined by F03 in Hz) being assumed as 4000hex.

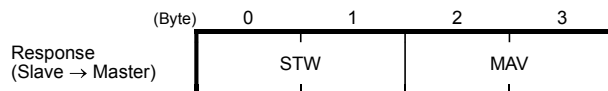

STW: Status word (2 bytes) that sends the running status of the inverter to be monitored at the master node.

MAV: Sends the current output frequency of the inverter to be monitored at the master node, which is expressed relative to the maximum frequency (defined by F03 in Hz) being assumed as 4000hex.

Given below is a PROFIBUS-DP communication sample in which the master node runs the inverter in the forward direction in 60 Hz.

- (1) Turning the inverter ON initiates PROFIBUS-DP communication. Immediately after the power is ON, the data in the request/response frames is as follows.

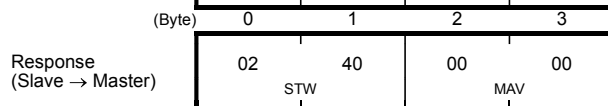
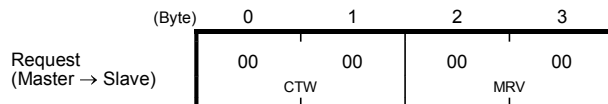

STW: Data 02 indicates that frequency and run commands from PROFIBUS are enabled. Data 40 indicates that the inverter is not ready to turn a run command ON.

MAV: Data 0000 means that the current output frequency is 0 Hz.

**ENGLISH**

(2) In step (1), the inverter is not ready to turn a run command ON as shown in STW.

First, enter the request data "04 7E" to CTW, to make the inverter ready to turn a run command ON. In the example below, the frequency command 60 Hz (maximum frequency being assumed as 4000hex) is entered to MRV at the same time.

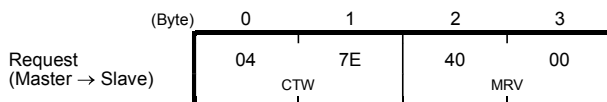

CTW: Data 04 enables the contents in this frame. Data 7E requests the inverter to get ready to turn a run command ON.

MRV: The frequency command is 4000hex (= Maximum frequency defined by F03 in Hz).

In response to the above request, the communications card returns the following response to the master node.

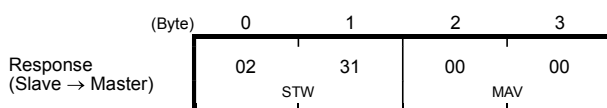

STW: Data 02 indicates that frequency and run commands from PROFIBUS are enabled. Data 31 indicates that the inverter is ready to turn a run command ON.

MAV: The current output frequency is 0 Hz.

(3) Since the inverter has been ready to turn a run command ON, enter run command data "04 7F" to CTW.

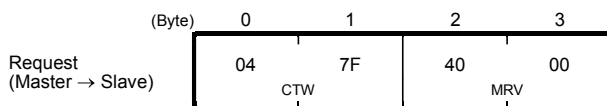

CTW: Data 04 enables the contents in this frame. Data 7F requests the inverter to turn a run command ON.

MRV: The frequency command is 4000hex (= Maximum frequency defined by F03 in Hz).

In response to the above request, the inverter starts running the motor. The communications card returns the following response to the master node.

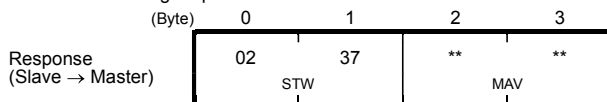

STW: Data 02 indicates that frequency and run commands from PROFIBUS are enabled. Data 37 indicates that the inverter is running.

MAV: The output frequency is accelerating.

(4) To stop the inverter, enter data "04 7E" to CTW.

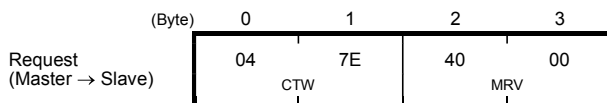

CTW: Data 04 enables the contents in this frame. Data 7E requests the inverter to turn the run command OFF.

MRV: The frequency command is 4000hex (= Maximum frequency defined by F03 in Hz).

In response to the above request, the inverter decelerates to a stop. The communications card returns the following response to the master node.

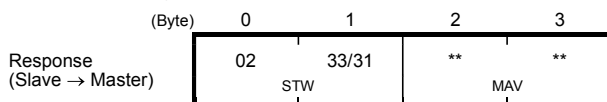

STW: Data 02 indicates that frequency and run commands from PROFIBUS are enabled. Data 33 indicates that the inverter is decelerating, and data 31 indicates that the inverter is ready to turn a run command ON (when the inverter is stopped).

MAV: The output frequency is decreasing.

- (5) To restart running the inverter, enter data "04 7F" to CTW. To run the inverter in the reverse direction, enter data "0C 7F" instead.

The example below specifies "Run reverse at the frequency of 30 Hz (2000hex)."

	(Byte) 0	1	2	3
Request (Master → Slave)	0C	7F	20	00
	CTW		MRV	

CTW: Data 0C enables the contents in this frame and requests the inverter to turn a run reverse command ON. Data 7F requests the inverter to turn a run command ON.

MRV: The frequency command is 2000hex (Frequency (Hz) =  $F03 \times 2000\text{hex}/4000\text{hex}$ ).

In response to the above request, the inverter starts running the motor in the reverse direction. The example below shows a response indicating that the inverter has reached the commanded frequency level in the reverse direction.

	(Byte) 0	1	2	3
Response (Slave → Master)	03	37	E0	00
	STW		MAV	

STW: Data 03 indicates that frequency and run commands from PROFIBUS are enabled and the output frequency arrives the reference one. Data 37 indicates that the inverter is running.

MAV: The current output frequency is E000hex (2's complement expression of 2000hex (Frequency =  $F03 \times -2000\text{hex}/4000\text{hex}$ )).

- (6) Entering a negative value to MRV also allows the inverter to run in the reverse direction. The example below enters E000hex, 2's complement of 2000hex.

	(Byte) 0	1	2	3
Request (Master → Slave)	04	7F	E0	00
	CTW		MRV	

CTW: Data 04 enables the contents in this frame. Data 7F requests the inverter to turn a run command ON.

MRV: The frequency command is E000hex (-2000hex) (Frequency =  $F03 \times -2000\text{hex}/4000\text{hex}$ ).

In response to the above request, the inverter starts running the motor in the reverse direction. The example below shows a response indicating that the inverter has reached the commanded frequency level in the reverse direction.

	(Byte) 0	1	2	3
Response (Slave → Master)	03	37	E0	00
	STW		MAV	

STW: Data 03 indicates that frequency and run commands from PROFIBUS are enabled and the output frequency arrives the reference one. Data 37 indicates that the inverter is running.

MAV: The current output frequency is E000hex (Frequency =  $F03 \times -2000\text{hex}/4000\text{hex}$ ).

- (7) If any trip occurs in the inverter, remove the trip factor and then enter data "04 80" to CTW to cancel the trip. After the trip is cancelled, enter data "04 00." (Note: The MSB in the 2nd byte (Byte 1) acts as a trip cancellation bit.)

	(Byte) 0	1	2	3
Request (Master → Slave)	04	80	10	00
	CTW		MRV	

CTW: Data 04 enables the contents in this frame. Data 80 requests canceling of the trip.

MRV: The frequency command is 1000hex (Frequency =  $F03 \times 1000\text{hex}/4000\text{hex}$ ).

Canceling a trip returns the inverter to the state immediately after the power is turned ON. To restart operation using PROFIBUS network, go back to step (2).

	(Byte) 0	1	2	3
Response (Slave → Master)	02	40	00	00
	STW		MAV	

STW: Data 02 indicates that frequency and run commands from PROFIBUS are enabled. Data 37 indicates that the inverter is running.

MAV: The current output frequency is 0000hex.

## Chapter 8 DETAILS OF PROFIBUS PROFILES

The communications card supports PROFIdrive V2 of a motor control profile which is instituted by the PROFIBUS Organization. This chapter describes the PROFIdrive profile.

### 8.1 Description of PPO Types Supported

The PROFIdrive profile defines several data formats called PPO (Parameter Process-data Object). The communications card supports four PPO types shown in Figure 8.1. Select a PPO type to apply to the communications card using the function code o30 (see Table 8.1). Table 8.2 lists the features of these PPO types. Tables 8.3 and 8.4 list the parts in the PPO.

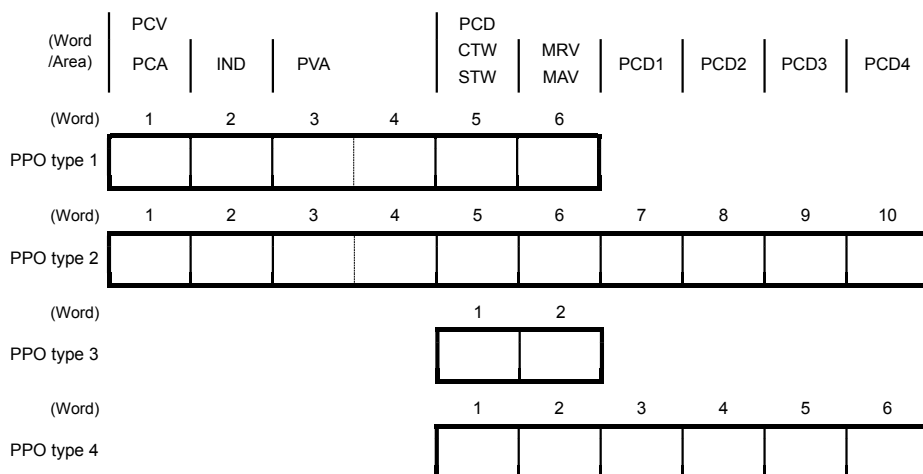

Figure 8.1 Data Formats of PPO Types Supported

Table 8.1 Choice of PPO Type Using the Inverter's Function Code o30

Data of o30	PPO	Remarks
0, 1, 6 to 255	PPO type 1	Factory default PPO type
2, 5	PPO type 2	
3	PPO type 3	
4	PPO type 4	



After configuring the function code o30, restart the inverter to enable the new settings.

Table 8.2 Features of PPO Types

PPO	Features
PPO type 1	Most typical data format that supports run command/running status monitor, frequency command/output frequency monitor, and on-demand accesses to inverter's function codes.
PPO type 2	Fully functional data format that supports run command/running status monitor, frequency command/output frequency monitor, on-demand accesses to inverter's function codes, and cyclic access to up to four inverter's function codes previously specified.
PPO type 3	Simplified data format specialized for defining run command/running status monitor and frequency command/output frequency monitor.
PPO type 4	Data format that supports cyclic access to up to four inverter's function codes previously specified, in addition to the features of PPO type 3.

Table 8.3 Parts in PPO

Parts	Description
PCD	Parameter area used for cyclic data communication with the PROFIBUS-DP master node. Run command/running status monitor and frequency command/output frequency monitor can be assigned to this area. PPO type 2 and type 4 additionally can assign arbitrary inverter's function codes to this area, enabling cyclic data writing and reading, each with up to four function codes.
PCV	Parameter area used for an on-demand access to the parameter (inverter's function codes and PROFIdrive specific parameters). PPO type 1 and type 2 support this area.

Table 8.4 Words in PCV and PCD Parts

Parts	Words	Function	Description
PCD	CTW/STW	Request	CTW: Control word that sends a run command from the master to the slave.
		Response	STW: Status word that returns the inverter's running status from the slave to the master as a response.
	MRV/MAV	Request	MRV: Word area that sends a frequency command expressed relative to the maximum frequency (defined by F03 in Hz) being assumed as 4000hex, from the master to the slave.
		Response	MAV: Word area that returns the current inverter's output frequency expressed relative to the maximum frequency (defined by F03 in Hz) being assumed as 4000hex, from the slave to the master.
	PCD1	Request	Word area that writes data of the inverter's function code specified by o40.
		Response	Word area that cyclically monitors data of the inverter's function code specified by o48.
	PCD2	Request	Word area that writes data of the inverter's function code specified by o41.
		Response	Word area that cyclically monitors data of the inverter's function code specified by o49.
	PCD3	Request	Word area that writes data of the inverter's function code specified by o42.
		Response	Word area that cyclically monitors data of the inverter's function code specified by o50.
	PCD4	Request	Word area that writes data of the inverter's function code specified by o43.
		Response	Word area that cyclically monitors data of the inverter's function code specified by o51.
PCV	PCA	Request	Word area that specifies the parameter (for the inverter's function code and PROFIBUS parameter) and access method to the parameter such as "write" and "read."
		Response	Word area that returns the parameter specified by the request above and the access result as a response.
	IND	Request /Response	Word area that is used to specify indexes of array parameters and inverter's function code numbers.
	PVA	Request /Response	Word area that shows the parameter value written or read.

ENGLISH

 For details about inverter's function codes o40 to o43 and o48 to o51, refer to Section 8.2, (4) "PCD1 to PCD4."

 **Tip** The "Request" and "Response" denote data transfer from the PROFIBUS master node to the inverter (slave node) equipped with the communications card and that from the inverter to the PROFIBUS master node, respectively.

## 8.2 PCD Word Area

The PCD word area controls the cyclic data transfer between the PROFIBUS-DP master node and the inverter (slave node) equipped with the communications card. It consists of CTW (run command), STW (running status monitor), MRV (frequency command), MAV (output frequency monitor), and PCD1 to PCD4 (cyclic accesses up to four inverter's function codes previously assigned) word areas.

### (1) CTW (Control word)

CTW is a word area for controlling the data transfer of run command and its related ones from the PROFIBUS-DP master node to the inverter (slave node) equipped with the communications card.

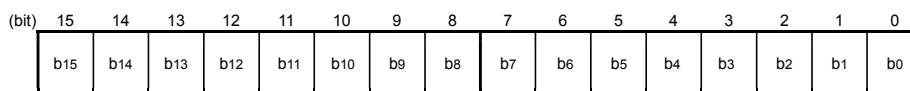





Table 8.5 Bit Definition in CTW

Bit	Command/Status	False (0)	True (1)
b0	ON/OFF	Turn a run command OFF	Turn a run command ON
b1	ON2/OFF2	OFF2: Coast to a stop	ON2: Request the inverter to be ready for turning a run command ON (1)
b2	ON3/OFF3	OFF3: Stop command following the deceleration time specified by the function code H56	ON3: Request the inverter to be ready for turning a run command ON (2)
b3	Enable operation	Disable inverter operation	Enable inverter operation
b4	Enable ramp generator	Fix the inverter output frequency at 0 Hz	Enable the ramp frequency generator (RFG)
b5	Unfreeze ramp generator	Freeze the RFG with the current output frequency fixed	Unfreeze RFG command
b6	Enable setpoint	Disable	Enable ON-bit
b7	ALM RST	Do not reset alarm	Reset alarm (Resetting an alarm makes the communications card unready to turn a run command ON.)
b8, b9	Not used.	---	---
b10	Enable PCD	Disable data entered in the PCD area (CTW+MRV)	Enable data entered in the PCD area (CTW+MRV)
b11	Run direction	Run in the forward direction	Run in the reverse direction
b12 to b15	Not used.	---	---

 For the use under the usual operation conditions, setting b1 through b6 and b10 to "1" could not cause any problem.

 The PROFIdrive profile controls an inverter, following the status transition in the communications card. It means that only turning a run command ON cannot run the inverter. After the inverter undergoes the status transition scheduled by the PROFIdrive profile and enters the appropriate state, a run command should be turned ON. The status word STW described in the next section informs you of the current status of the communications card.

 For the status transition condition of the PROFIdrive profile, refer to Section (2) "STW (status word)" and Figure 8.2 on the following pages.

 If you do not need any strict control with the status transition, follow the procedure given in Chapter 7 "QUICK SETUP GUIDE FOR RUNNING THE INVERTER."

**(2) STW (Status word)**

STW is a word area for monitoring the inverter's running status.

 STW indicates the status transition of the PROFIdrive. The status transition details are shown in Figure 8.2.

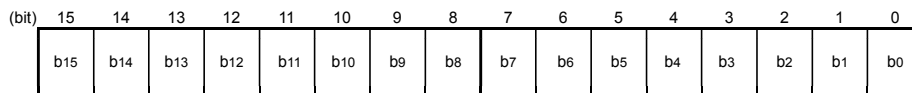



Table 8.6 Bit Definition in STW

Bit	Status	False (0)	True (1)
b0	Ready to switch ON	Not ready to turn a run command ON	Ready to turn a run command ON
b1	Ready to run	Not ready to run	Ready to run
b2	Running state	Running disabled	Running
b3	ALM	No inverter trip present	Inverter being tripped
b4	ON2/OFF2	OFF2: b1 in CTW is "0"	ON2: b1 in CTW is "1"
b5	ON3/OFF3	OFF3: b2 in CTW is "0"	ON3: b2 in CTW is "1"
b6	Run command ON inhibited	Ready to turn a run command ON (logical negation of b0)	Not ready to turn a run command ON (logical negation of b0)
b7	Not used.	---	---
b8	FAR	Not reached the reference frequency	Reached the reference frequency
b9	R/L	Both frequency and run commands from PROFIBUS are invalid	Either one of frequency and run commands from PROFIBUS is valid
b10	FDT	Output frequency has not reached the level specified by the function code E31	Output frequency has reached or exceeded the level specified by the function code E31
b11 to b15	Not used.	---	---

ENGLISH

Figure 8.2 shows a status transition diagram of the PROFIdrive profile.

Immediately after the inverter is turned ON, the status first moves to S1 "Not ready to turn a run command ON." Bit manipulation in CTW shifts the status to S2 "Ready to turn a run command ON," S3 "Ready to run" and finally S4 "Running" in sequence. In S4 state, the inverter enters the running state. Turning a run command OFF in S4 state shifts the status to S5 "Turn a run command OFF." After the motor stops, the status moves to S2 or S1 state.

 In Figure 8.2, to simplify the description, values of Bit 4 to Bit 6 and Bit 10 in CTW are always "1." If any one of these bit values is not "1," the inverter will not enter the running state even if the status transition properly proceeds.



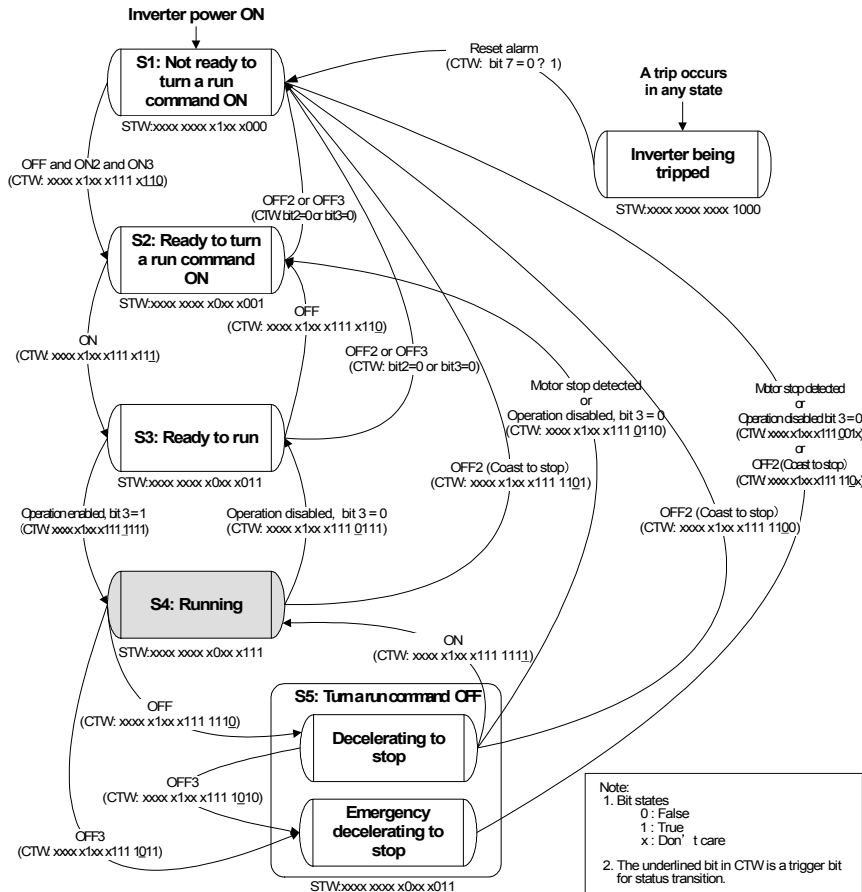

Figure 8.2 Status Transition Diagram of PROFIdrive Profile

- Tip** Run commands and frequency/speed commands by inverter's function codes S06, S01, S05, and S19. Run commands specified by S06 (bit 0, 1) and frequency/speed commands by S01, S05, and S19 are available in S1 state. Shifting from S1 to any other state during execution of any of these commands immediately causes the inverter to follow commands specified by CTW and MRV. Bits 2 to 15 of S06 are available in any state.
- Note** In S4 or S5 state, shifting to S1 state with OFF2 (Coast to a stop) or OFF3 (Rapidly decelerate to a stop) disables a run command specified by inverter's function code S06 (running at 0 Hz, to be exact) even in S1 state. To enable the run command, enter ON2 or ON3.
- Note** Performing auto-tuning via a PROFIBUS-DP network runs the inverter at the specified frequency, independent of the state transition.
- For auto-tuning, refer to the Instruction Manual and the User's Manual of the corresponding inverter.**

**(3) MRV (frequency command) and MAV (output frequency)**

MRV and MAV are word areas for setting a frequency command and monitoring an output frequency, respectively.

MRV: Frequency command word area that sends a frequency command from the PROFIBUS-DP master node to an inverter (slave node).

MAV: Output frequency monitoring word area that returns the current inverter's output frequency to the PROFIBUS-DP master node as a response from the inverter (slave node).

In each word, the frequency is expressed relative to the maximum frequency (defined by F01 in Hz) being assumed as 4000hex. The conversion expression is shown below.

$$\text{MRV or MAV} = \frac{\text{Frequency(Hz)}}{\text{FunctioncodeF03(Hz)}} \times 4000\text{hex} \quad \text{Frequency(Hz)} = \text{Functioncode F03 (Hz)} \times \frac{\text{MRV or MAV}}{4000\text{hex}}$$

**Tip** A negative value is expressed by 2's complement of 4000hex. When the inverter is running in the *reverse* direction, the value of MAV (output frequency) is a negative value. Setting a negative value to MRV (frequency command) causes even a run *forward* command to run the motor in the *reverse* direction.

**(4) PCD1 to PCD4**

PCD1 to PCD4 are word areas exclusively supported by PPO type 2 and type 4. They enable cyclic write request and read (monitor) response to/from up to four inverter's function codes previously specified for each of PCD1 to PCD4.

**Note** Values written and read to/from the specified function codes are in the same data format as defined in individual inverter's function codes.

For the formats of inverter's function codes, refer to the RS-485 Communication User's Manual, Chapter 5, Section 5.2 "Data Formats."

To assign inverter's function codes to PCD1 to PCD4 words, use function codes o40 to o43 and o48 to o51 as listed in Table 8.7. Table 8.8 on the next page shows how to use these function codes.

Table 8.7 Function Codes to Assign Inverter's Function Codes to PCD1 to PCD4 Words

	PCD area	Function codes	Remarks
Request (Write a function code)	PCD1	o40	Also assignable by PNU915, index 1 *
	PCD2	o41	Also assignable by PNU915, index 2 *
	PCD3	o42	Also assignable by PNU915, index 3 *
	PCD4	o43	Also assignable by PNU915, index 4 *
Response (Monitor a function code)	PCD1	o48	Also assignable by PNU916, index 1 *
	PCD2	o49	Also assignable by PNU916, index 2 *
	PCD3	o50	Also assignable by PNU916, index 3 *
	PCD4	o51	Also assignable by PNU916, index 4 *

\* PNU915 and PNU916 refer to PROFIdrive specific parameters. For details, refer to Section 8.3 (4) "PROFIdrive specific parameters."

For details of assignment of inverter's function codes using function codes o40 to o43 and o48 to o51, refer to the descriptions on the next page.

To assign an inverter's function code to PCD1 to PCD4 word areas using function codes o40 to o43 and o48 to o51, enter four digit hexadecimal to specify the function code group and number as listed in Table 8.8.

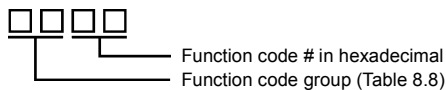

Set function codes as is if specifying settings at the multi-function keypad (option).

(Example) If C05: C05

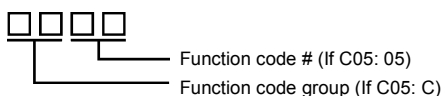

**Note** Run commands specified by S06 (bit 0, 1) and frequency/speed commands by S01, S05, and S19 are available in S1 state. Shifting from S1 to any other state during execution of any of these commands immediately causes the inverter to follow commands specified by CTW and MRV.

Bits 2 to 15 of S06 are available in any state.

For details about inverter's communication-related function codes S01, S05, S06 and S19, refer to the RS-485 Communication User's Manual, Chapter 5, Section 5.1 "Communications Dedicated Function Codes."

Table 8.8 Function Code Group Conversion Table

Function code group	Group number	Function code name	Function code group	Group number	Function code name	
S	2	02hex	Command/function data	W2	24 18h	Monitor 4
M	3	03hex	Monitor data	W3	25 19h	Monitor 5
F	4	04hex	Fundamental functions	X1	26 1Ah	Alarm 3
E	5	05hex	Extension terminal functions	X2	27 1Bh	Reserved
C	6	06hex	Control functions	Z1	28 1Ch	Reserved
P	7	07hex	Motor 1 parameters	K	29 1Dh	Keypad function
H	8	08hex	High performance functions	T	30 1Eh	Clock timer function
A	9	09hex	Motor 2 parameters	E1	31 1Fh	Reserved
o	10	0Ahex	Option functions	H1	32 20h	High level function 1
r	12	0Chex	Motor 4 parameters	o1	33 21h	Optional function 1
J	14	0Ehex	Application functions 1	U1	34 22h	Customized logic function
y	15	0Fhex	Link functions	M1	35 23h	Reserved
W	16	10hex	Monitor data 2	J1	36 24h	PID control 1
X	17	11hex	Alarm 1	J2	37 25h	PID control 2
Z	18	12hex	Alarm 2	J3	38 26h	Reserved
b	19	13hex	Motor 3 parameters	J4	39 27h	Reserved
d	20	14hex	Application functions 2	J5	40 28h	External PID control 1
W1	23	17h	Monitor 3			

Example for F26 F ⇒ Function code group 04hex  
 26 ⇒ Function code number 1Ahx } "041A"

- Note**
- After configuring function codes o40 to o43 and o48 to o51, restart the inverter to enable the new settings.
  - Double assignment of a same function code to o40 to o43 enables only the o code with the youngest number and ignores other assignments.
  - Even in assignment of different function codes to o40 to o43, assignment of two or more out of inverter's function codes S01, S05, and S19 (Frequency/speed commands) at the same time enables only the o code with the youngest number and ignores other assignments. This is because S01, S05, and S19 are internally treated as a same one.

### 8.3 PCV Word Area

The PCV word area controls an on-demand access to parameters (inverter's function codes and PROFIdrive specific parameters). It is supported by PPO type 1 and type 2. Its structure is shown below.

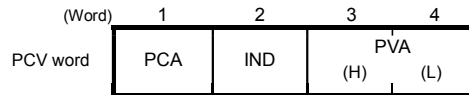
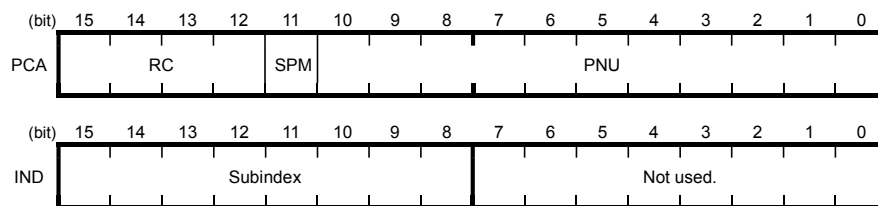

Figure 8.3 Structure of PCV Word Area

#### (1) PCA and IND

These two word areas specify a parameter. Their structures are shown below.



- RC: Request code/response code (See Table 8.9.)
- SPM: Not used. Fixed at "0."
- PNU: Parameter number to be accessed
- Subindex: Inverter's function code number (numeric following a function code group) or an index number of array PROFIdrive specific parameters.

**Tip** To specify an inverter's function code, use PNU and Subindex areas. Enter "Function code group + 100hex" (see Table 8.8) to the PNU area, and the function code number to the Subindex area.

For how to specify and read/write an inverter's function code, refer to Section 8.3 (3) "Access to inverter's function codes and PROFIdrive specific parameters."

Table 8.9 RC Part

RC part	Request/response	Descriptions
0	Request (Master → Slave)	No request
1		Read parameter value
2		Write parameter value in word
3 to 5		Not used.
6		Read array parameter value
7		Write array parameter in array word
8		Not used.
9		Read element count of array parameter
10 to 15		Not used.
0		Response (Slave → Master)
1	Parameter value in word sent normally	
2, 3	Not used.	
4	Parameter value in array word sent normally	
5	Not used.	
6	Normal response to the request of array element count	
7	Transmission error (Error code stored in PVA)*	
8 to 15	Not used.	

\* For error codes and information, see Table 8.10.

Table 8.10 List of Error Codes for Parameter Access Errors

RC part	Error code stored in PVA word	Error information
7	0	Nonexistent parameter specified
	1	Parameter value writing inhibited
	2	Specified parameter value out of range
	3	Invalid Subindex specified
	4	Specified parameter not array
	11	Parameter write-protect error during inverter running or digital input terminal (for run command) being ON
	17	Read process not executable
	104	Busy error during parameter writing

**(2) PVA word area**

PVA is a two-word area that represents write/read parameter values. The communications card uses the lower one word (the fourth word counted from the PCV word head).

To write a parameter value into an inverter (slave node), enter the value to the master node and send the word to the slave. To read a parameter value, refer to this area of the slave node in response to the previous request. If a parameter access error occurs (Response to RC part is "7"), the slave node outputs an error code (Table 8.10) to this area and returns the response to the master node.

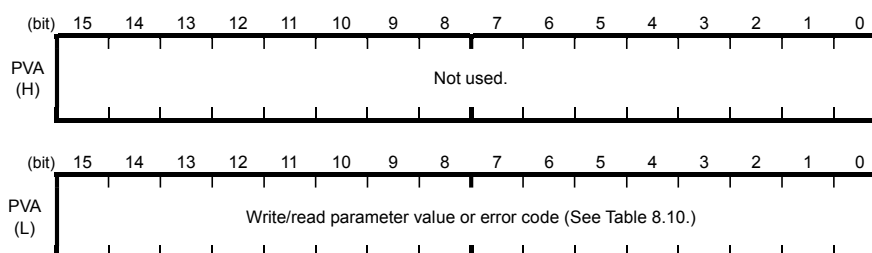

**(3) Access to inverter's function codes and PROFIdrive specific parameters**

- 1) Specify the target parameter to be accessed using PNU and Subindex areas (see Figure 8.4).  
When specifying an inverter's function code, enter the numeral of "Function code group number + 100hex" (see Table 8.8) to the PNU area, and "Function code number" to the Subindex area. For example, enter "104 01" for F01.
- 2) Specify how to access the specified parameter, for example, Write or Read, in the RC area. For details about the RC area, see Table 8.9.
- 3) To write a parameter value, enter the write data into the PVA lower area and send the word to the slave node. To read a parameter value from the slave, refer to the PVA lower area in the response from the slave node. If a parameter access error occurs, the RC part of the response is filled with "7" and the PVA area contains one of the error codes listed in Table 8.10.

**Note** Run commands specified by S06 (bit 0, 1) and frequency/speed commands by S01, S05, and S19 are available in S1 state. Shifting from S1 to any other state during execution of any of these commands immediately causes the inverter to follow commands specified by CTW and MRV. Bits 2 to 15 of S06 are available in any state.

For details about inverter's communication-related function codes S01, S05, S06 and S19, refer to the RS-485 Communication User's Manual, Chapter 5, Section 5.1 "Communications Dedicated Function Codes."

Values written and read to/from the specified function codes are in the same data format as defined in individual inverter's function codes. For the formats of inverter's function codes, refer to the RS-485 Communication User's Manual, Chapter 5, Section 5.2 "Data Formats."

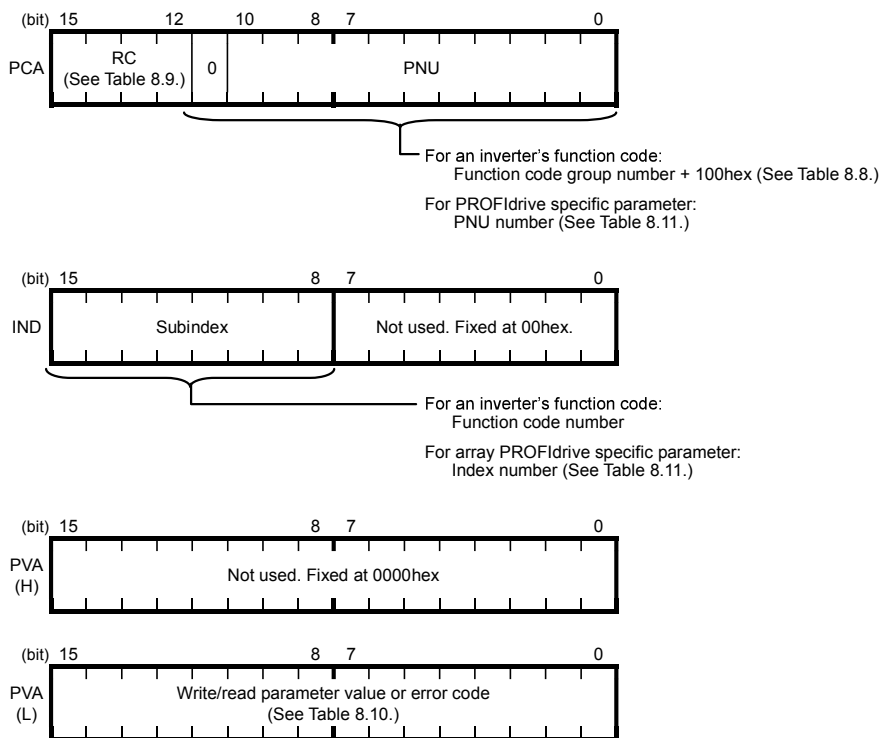
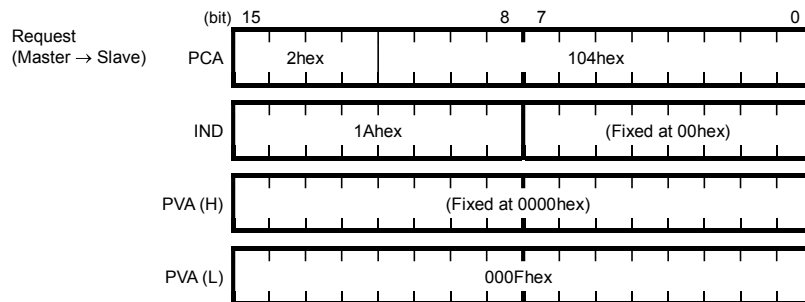

Figure 8.4 How to Access Parameters

Actual parameter access examples are shown below.

**Example 1: Writing data "15" to the inverter's function code F26**

- 1) Send the request to write data "15" to the inverter's function code F26, from the master node to the slave node (inverter)
  - RC = 2hex → Write parameter value (word).
  - PNU = 104hex, Subindex = 1Ahex → Specify F26 (Function code group number 04h + 100hex = 104hex, Function code number = 1Ahex).
  - PVA=0000 000F(hex) → Enter parameter value 15 (= 000Fhex).



- 2) Response example sent from the communications card (normal response from the slave node)
  - RC = 1hex → Requested parameter value is normally returned.
  - PNU = 104hex, Subindex = 1Ahex → Accessed parameter is function code F26.
  - PVA = 0000 000Fhex → Parameter value written is 15.

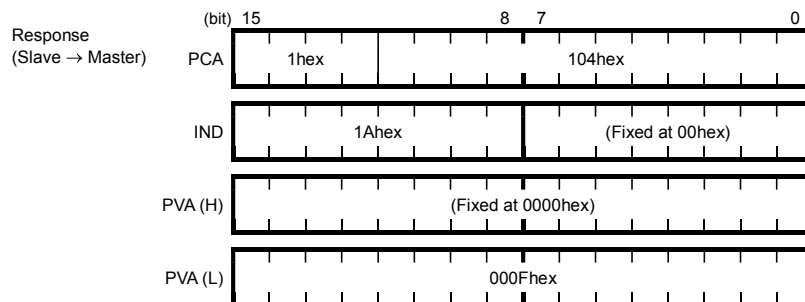

- 3) Response example for the write data error (Specified parameter value out of range)
  - RC = 7hex → Parameter value transmission error.
  - PNU = 104hex, Subindex = 1Ahex → Accessed parameter is function code F26.
  - PVA = 0000 0002hex → Error code 2 (Specified parameter value out of range)

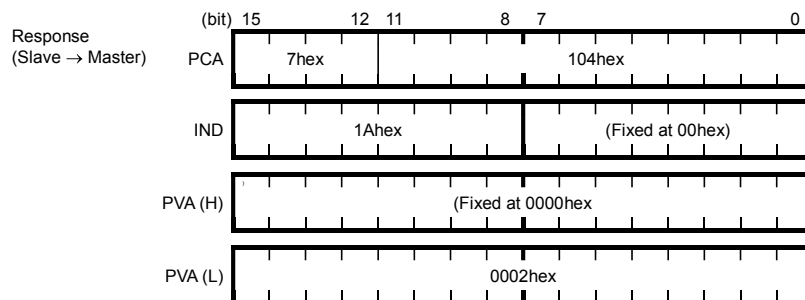

**Example 2: Reading (monitoring) data from the inverter's function code y98**

- 1) Send the request to read data from the function code y98, from the master node to the slave node.
  - RC = 1hex → Read parameter value.
  - PNU = 10Fhex, Subindex = 62hex → Specify y98 (Function code group number 0Fhex + 100hex = 10Fhex, Function code number = 62hex)
  - PVA = 0000 0000hex → No entry required for PVA.

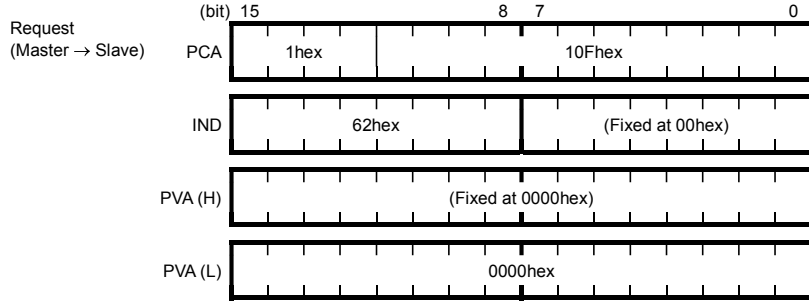

- 2) Response example sent from the communications card (normal response from the slave node)
  - RC = 1hex → Requested parameter value is normally returned.
  - PNU = 10Fhex, Subindex = 62hex → Accessed parameter is function code y98.
  - PVA = 0000 0003hex → Parameter value read is 3.

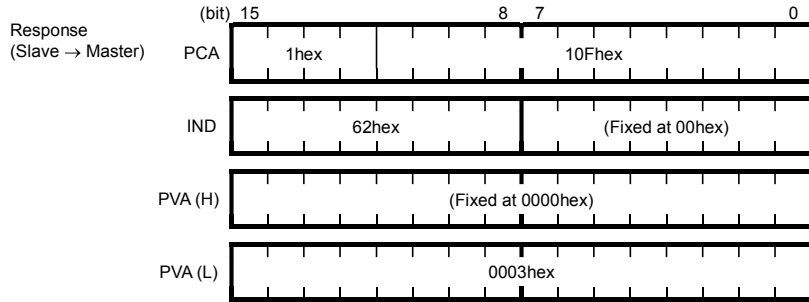

- 3) Response example for the read data error (Specified function code does not exist)
  - RC = 7hex → Parameter transmission error.
  - PNU = 10Fhex, Subindex = 64hex → Accessed parameter is function code y100.
  - PVA = 0000 0000hex → Error code 0 (Nonexistent parameter specified)

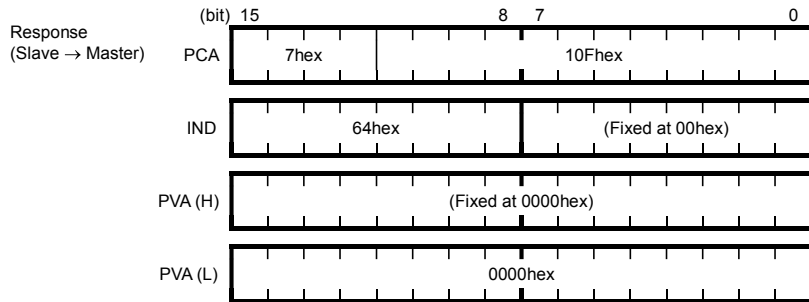



**Example 3: Reading from an array PROFIdrive specific parameter PNU947 (Alarm history)**

1) Send the request to read PNU947 from the master node to the slave node. The example below reads Index 1.

- RC = 6hex → Read an array parameter.
- PNU = 3B3hex, Subindex = 1hex → Specify PNU947 (= 3B3hex) and Index 1.
- PVA = 0000 0000hex → No entry required for PVA.

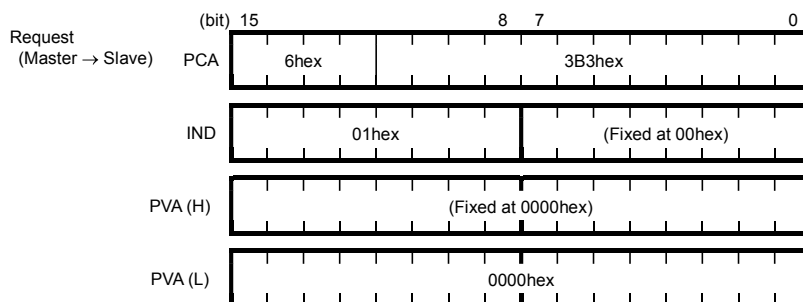

2) Response example sent from the communications card (normal response from the slave node)

- RC = 4hex → Requested array parameter value is normally returned.
- PNU = 3B3(hex), Subindex = 01 hex → Accessed parameter is PNU947 (=3B3hex), Index 1.
- PVA = 0000 7511hex → Parameter value read is 7511hex, PROFIBUS communications error *E-5*

For the values of PNU947, refer to Chapter 11 "LIST OF INVERTER ALARM CODES."

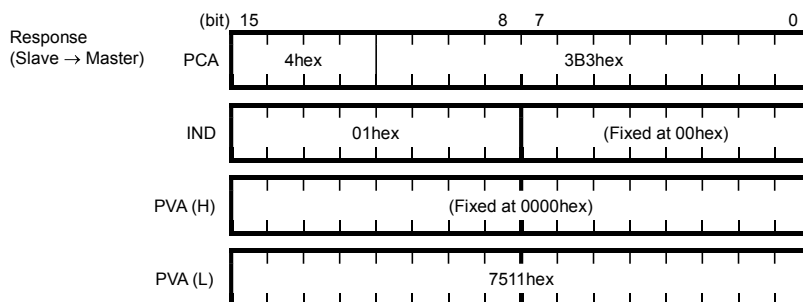

3) Response example for the read data error (Accessed parameter cannot be read as an array parameter.)

- RC = 7hex → Parameter transmission error.
- PNU = 3B3hex, Subindex = 01hex → Accessed parameter is function code y100.
- PVA = 0000 0003hex → Error code 3 (Invalid Subindex specified)

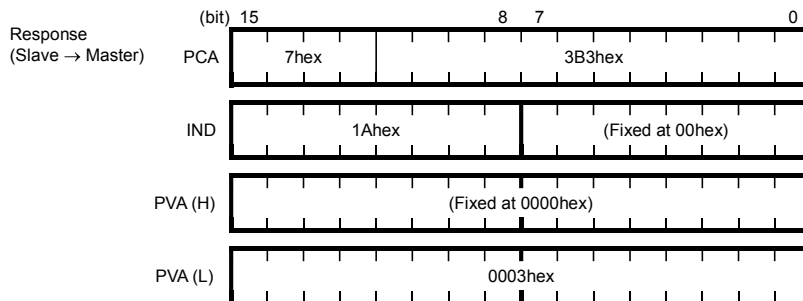

**(4) PROFIdrive specific parameters**

Table 8.11 lists PROFIdrive specific parameters supported by the communications card. PNUs with descriptions in the index column are array parameters.

Table 8.11 List of PROFIdrive Specific Parameters

PNU	Index	Description	Range	R/W	Remarks
915	1 to 4	Function code assignment to PCD1 to PCD4 (Request) (Write function code data)	0000 to FFFFhex	R/W	Same as o40 to o43.
916	1 to 4	Function code assignment to PCD1 to PCD4 (Response) (Read/monitor function code data)	0000 to FFFFhex	R/W	Same as o48 to o51.
918	None	Node (station) address	0 to 125	R	
927	None	Access permission to PCV area 0: Inhibit to write 1: Permit to write	0 or 1	R/W	Once writing is inhibited, this PNU only is writable.
947	1	Malfunction history (Latest)	Depends on errors listed in Table 11.1.	R	Indicated by PROFIdrive malfunction codes whose data formats differ from the ones of inverter's alarm codes defined by inverter's function codes M16 to M19.*
	9	Malfunction history (Last)			
	17	Malfunction history (2nd last)			
	25	Malfunction history (3rd last)			
	Other than the above	Fixed to 0.			
963	None	Current baud rate 0: Not specified    1: 9.6 kbps 2: 19.2 kbps        3: 45.45 kbps 4: 93.75 kbps      5: 187.5 kbps 6: 500 kbps         7: 1.5 Mbps 8: 3 Mbps            9: 6 Mbps 10: 12 Mbps	0 to 10	R	
965	None	PROFIdrive version	Fixed to 2	R	Shows PROFIdrive V2.
967	None	Last CTW sent	0000 to FFFFhex	R	
968	None	Latest STW	0000 to FFFFhex	R	
970	None	Initialize the inverter (Changing from "1" to "0" triggers the initialization.)	0 or 1	R/W	Functionally equivalent to H03.

\* For the relationship between the malfunction codes and alarm codes, refer to Chapter 11 "LIST OF INVERTER ALARM CODES."

ENGLISH

## Chapter 9 ERROR PROCESSING FOR PROFIBUS NETWORK BREAKS

The PROFIBUS-DP master node can set up a watchdog timer (WDT) that detects a communications timeout for monitoring the communications status.

If the communications card receives data once but receives no more data within the WDT timeout length, it interprets the timeout as a PROFIBUS network break. An inverter's error processing after detection of a network break can be selected with function codes o27 and o28 as listed in Table 9.1.

 For the setup of WDT in the PROFIBUS-DP master, see the user's manual of your master equipment.

 For the error indication on the communications card at the time of a communications error, see Chapter 2, Section 2.6 "LED Status Indicators."



 **Note** If the inverter detects a PROFIBUS network break immediately after it is turned on, it does not trip with  $\bar{E}r5$ . If the inverter detects a network break after normal reception of data once, it trips with  $\bar{E}r5$ .

Table 9.1 Error Processing for PROFIBUS Network Breaks

o27 data	o28 data	Error Processing after Detection of PROFIBUS Network Break	Remarks
0, 4 to 9	Invalid	Immediately coast to a stop and trip with $\bar{E}r5$ .	
1	0.0 to 60.0 s	After the time specified by o28, coast to a stop and trip with $\bar{E}r5$ .	
2	0.0 to 60.0 s	If the communications link is restored within the time specified by o28, ignore the communications error. If a timeout occurs, coast to a stop and trip with $\bar{E}r5$ .	
3, 13 to 15	Invalid	Keep the current operation, ignoring the communications error. (No $\bar{E}r5$ trip)	During the communications error state, the LED displays the abnormal state. (PWR: Flashes in red, OFFL: Lights in red.)
10	Invalid	Immediately decelerate to a stop. Issue $\bar{E}r5$ after stopping.	The inverter's function code F08 specifies the deceleration time.
11	0.0 to 60.0 s	After the time specified by o28, decelerate to a stop. Issue $\bar{E}r5$ after stopping.	Same as above.
12	0.0 to 60.0 s	If the communications link is restored within the time specified by o28, ignore the communications error. If a timeout occurs, decelerate to a stop and trip with $\bar{E}r5$ .	Same as above.

 **Tip** Selecting  $\bar{E}r5$  to regard it as a light alarm allows the inverter to continue running even if a PROFIBUS network breaks, regardless of the function code o27 setting.

## Chapter 10 PROCESSING TO BE APPLIED UPON RECEIPT OF ALL-ZERO DATA

Inverter's function code o32 specifies inverter's processing to be applied when the communications card receives all-zero data, as listed in Table 10.1.



Some master node equipment sends all-zero data to all slaves if a PLC application error occurs or the application program stops.

Table 10.1 Processing to be Applied upon Receipt of All-zero Data

o32 data	Processing to be Applied upon Receipt of All-zero Data	Conditions
0	Keep the current operation, ignoring all-zero data.	Factory default
1	Coast to a stop and shift to S1 state. *1	
2	Keep the current operation, ignoring all-zero data.	Bit 10 of CTW received last time is 0.
	Coast to a stop and shift to S1 state. *1	Bit 10 of CTW received last time is 1.

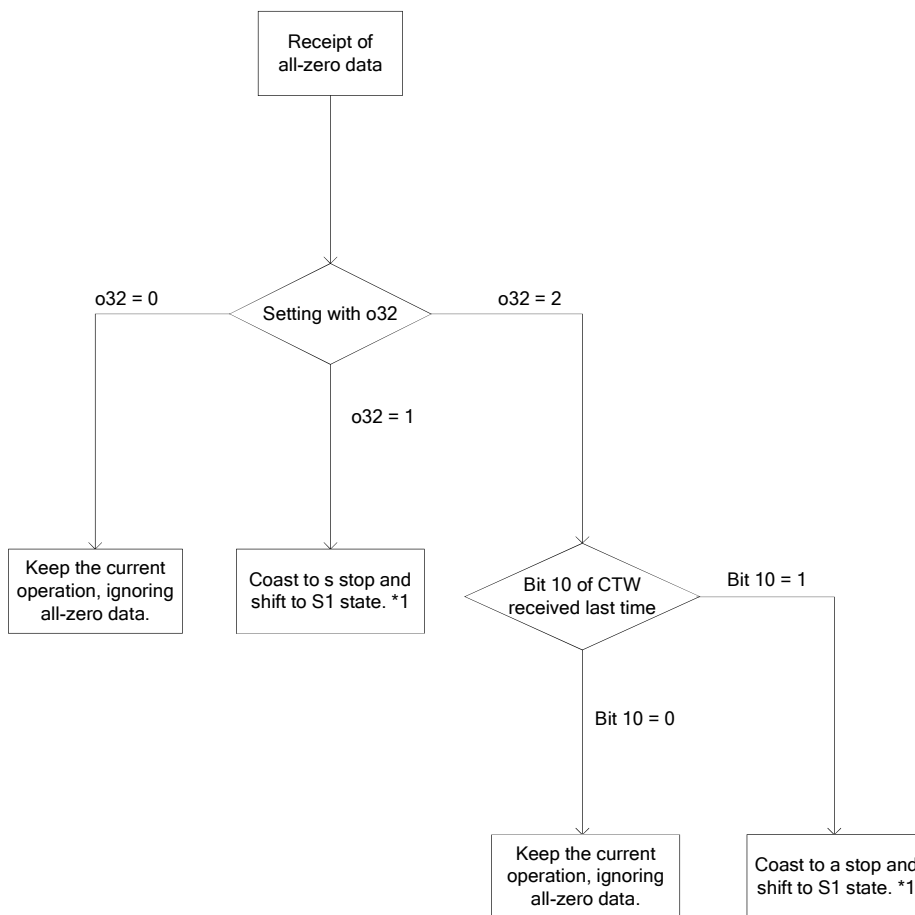

Figure 10.1 Flowchart of Processing to be Applied Upon Receipt of All-Zero Data

\*1 For details about the S1 state, refer to Figure 8.2 "Status Transition Diagram of PROFIdrive Profile" in Chapter 8 "DETAILS OF PROFIBUS PROFILES."

## Chapter 11 LIST OF INVERTER ALARM CODES

In PROFIBUS-DP communication, alarms that occur in the inverter can be monitored with malfunction codes in the PROFIdrive specific parameter PNU947 or with alarm codes in the inverter's function codes M16 through M19.

(1) PROFIdrive specific parameter PNU947

(2) Inverter's function codes M16, M17, M18 and M19 (latest, last, 2nd last, and 3rd last alarm codes).

Table 11.1 lists their malfunction codes and alarm codes.

 **Note** The data format used for PNU947 is different from that for the inverter's function codes M16 to M19.

 For details about PNU947, refer to Chapter 8, Section 8.3 (4) "PROFIdrive specific parameters."

Table 11.1 Malfunction Codes and Alarm Codes

Malfunction codes in PNU947	Alarm codes in M16 to M19	Description	Malfunction codes in PNU947	Alarm codes in M16 to M19	Description		
0000	0	---	---	7301	28	PG wire break	<i>PG</i>
2301	1	Overcurrent (during acceleration)	<i>OC1</i>	5500	31	Memory error	<i>E-1</i>
2302	2	Overcurrent (during deceleration)	<i>OC2</i>	7520	32	Keypad communication error	<i>E-2</i>
2303	3	Overcurrent (during running at constant speed)	<i>OC3</i>	5220	33	CPU error	<i>E-3</i>
2330	5	Grounding fault	<i>EF</i>	7510	34	Option communications error (Communications card hardware error)	<i>E-4</i>
3211	6	Overvoltage (during acceleration)	<i>OU1</i>	7511	35	Option error (PROFIBUS communications error)	<i>E-5</i>
3212	7	Overvoltage (during deceleration)	<i>OU2</i>	F004	36	Operation protection	<i>E-6</i>
3213	8	Overvoltage (during running at constant speed or being stopped)	<i>OU3</i>	7200	37	Tuning error	<i>E-7</i>
3220	10	Undervoltage	<i>LU</i>	B100	38	RS-485 communications error (COM port 1)	<i>E-8</i>
3130	11	Input phase loss	<i>Li n</i>	2212	44	Motor overload 3	<i>OL3</i>
5450	14	Blown fuse	<i>FUS</i>	2212	45	Motor overload 4	<i>OL4</i>
5440	16	Charging circuit fault	<i>PbF</i>	3300	46	Output phase loss	<i>OPL</i>
4310	17	Overheating of the heat sink	<i>OH1</i>	8400	47	Speed mismatch (Excessive speed deviation)	<i>E-E</i>
9000	18	External alarm	<i>OH2</i>	6300	51	Data save error due to undervoltage	<i>E-F</i>
4110	19	Inverter overheat	<i>OH3</i>	7520	53	RS-485 communications error (COM port 2)	<i>E-P</i>
4310	20	Motor protection (PTC/NTC thermistor)	<i>OH4</i>	5220	54	Hardware error	<i>E-H</i>
4210	22	Braking resistor overheated	<i>dbH</i>	8500	56	Positioning control error	<i>E-o</i>
2211	23	Motor overload 1	<i>OL1</i>	5430	57	Enable circuit failure	<i>ECF</i>
2212	24	Motor overload 2	<i>OL2</i>	7200	58	PID feedback wire error	<i>LoF</i>
2200	25	Inverter overload	<i>OLU</i>	5400	59	Braking transistor broken	<i>dbR</i>
7310	27	Overspeed	<i>OS</i>	FF00	254	Mock alarm	<i>E-r</i>
7300	29	NTC wire break error	<i>nr b</i>	FFFF	---	Charging resistance overheating	<i>OH5</i>

## Chapter 12 TROUBLESHOOTING

If any problem occurs with the communications card, follow the troubleshooting procedures below.

No.	Problems	Possible causes
1	None of the LEDs on the communications card would light.	<ul style="list-style-type: none"> <li>The inverter is not powered ON.</li> <li>The communications card is not properly installed.</li> <li>The communications card is defective.</li> </ul>
2	The inverter cannot escape from the $E_r4$ alarm trip. The PWR LED lights in red.	<ul style="list-style-type: none"> <li>The communications card is not properly installed.</li> <li>The communications card is not powered ON.</li> <li>The communications card is defective.</li> </ul>
3	PROFIBUS communication is not possible. The PWR LED blinks in red and the OFFL LED lights in red.	<ul style="list-style-type: none"> <li>The valid GSD file has not been registered to the PROFIBUS master node.</li> <li>The node address of the communications card is not identical with the one registered to the PROFIBUS master node.</li> <li>Node addresses duplicated.</li> <li>The cabling does not meet PROFIBUS-DP requirements.</li> <li>The cable used is not a PROFIBUS-DP dedicated one.</li> <li>Terminating resistors are not inserted at both ends of the PROFIBUS-DP communications network.</li> </ul>
4	PROFIBUS communications is not possible. The ERR LED blinks in red.	<ul style="list-style-type: none"> <li>The inverter's function code o30 has not been configured. The data for o30 should be identical with the PPO type registered for the PROFIBUS master node.</li> <li>The inverter has not been restarted after setting of the function code o30.</li> </ul>
5	The inverter cannot escape from the $E_r5$ alarm trip. or The inverter trips with $E_r5$ soon after starting PROFIBUS communication. The PWR LED blinks in red and the OFFL LED lights in red.	<ul style="list-style-type: none"> <li>The timeout length specified in the watchdog timer in the PROFIBUS master node equipment is too short.</li> <li>The inverter's function code o31 is set to "126" or greater.</li> <li>The cable used is not a PROFIBUS-DP dedicated one..</li> <li>The communications card is not grounded.</li> </ul>
6	Run or frequency command by CTW or MRV is not validated.	<ul style="list-style-type: none"> <li>The inverter's function code y98 is not set to "3."</li> <li>Run or frequency command specified by the function code has priority. (e.g. y99 specifies, terminal command <b>LE</b> or <b>LOC</b>)</li> <li>Check the PPO type format selected.</li> </ul>
7	PCD1 to PCD4 assignments for PPO type 2 or type 4 are not validated properly.	<ul style="list-style-type: none"> <li>The inverter's function code o30 is not set. Or the inverter has not been restarted after setting of the function code o30.</li> <li>The inverter has not been restarted after setting of function codes o40 to o43 and o48 to o51.</li> </ul>
8	Setting the node address to "0" does not take effect.	<ul style="list-style-type: none"> <li>The inverter has not been restarted after changing of the node address.</li> <li>The inverter's function code o31 is set to nonzero.</li> </ul>
9	Frequency command validated, but the actual motor speed is different from the command.	<ul style="list-style-type: none"> <li>Refer to the contents of the relevant items of the Instruction Manual and the User's Manual.</li> </ul>

ENGLISH

## Chapter 13 SPECIFICATIONS

### 13.1 General Specifications

The operating environment for this communications card is based on the inverter unit specification.

### 13.2 PROFIBUS-DP Specifications

Table 13.2 lists the PROFIBUS-DP specifications for the communications card. For the items not covered in this section, the PROFIBUS-DP specifications apply.

Table 13.2 PROFIBUS-DP Specifications

Item	Specifications	Remarks	
Transmission section	Transfer specification	RS-485 (insulated cable)	
	Total extension distance	See Table 13.3	
	Transmission speed	9.6 kbps to 12 Mbps (auto configuration)	To be specified in the master node
	Protocol	PROFIBUS-DP (DP-V0)	IEC 61158 and 61784
Connector	Pluggable, six-pin terminal block	TFMC 1.5/6-STF-3.5 manufactured by Phoenix Contact Inc.	
Addressing	By on-board node address switches (rotary switches) (0 to 99) or By inverter's function code o31 (data = 0 to 125)	Setting both node address switches SW1 and SW2 to "0" enables the o31 setting.	
Diagnostics	Detection of cable break	Indicated by the OFFL LED	
	Detection of the illegal configuration	Indicated by the ERR LED	

Maximum cable length per segment for PROFIBUS-DP specific cable

Table 13.3 Maximum Cabling Length for PROFIBUS-DP Communication

Transmission speed	Maximum cable length (m) per segment
9.6 kbps	1200
19.2 kbps	1200
45.45 kbps	1200
93.75 kbps	1000
187.5 kbps	1000
500 kbps	400
1.5 Mbps	200
3 Mbps	100
6 Mbps	100
12 Mbps	100

**PROFIBUS-DP 通信カード / PROFIBUS-DP Communications Card  
"OPC-PDP3"**

---

**取扱説明書 / Instruction Manual**

First Edition, January 2016

Fuji Electric Co., Ltd.

---

- この取扱説明書の一部または全部を無断で複製・転載することはお断りします。
- この説明書の内容は将来予告なしに変更することがあります。
- 本書の内容については、万全を期して作成いたしましたが、万一ご不審の点や誤り、記載もれなど、お気づきの点がありましたら、ご連絡ください。
- 運用した結果の影響については、上項にかかわらず責任を負いかねますのでご了承ください。

The purpose of this manual is to provide accurate information in the handling, setting up and operating of the PROFIBUS-DP Communications Card for the FRENIC series of inverters. Please feel free to send your comments regarding any errors or omissions you may have found, or any suggestions you may have for generally improving the manual.

In no event will Fuji Electric Co., Ltd. be liable for any direct or indirect damages resulting from the application of the information in this manual.



---

**富士電機株式会社**

**パワエレ機器事業本部 ドライブ事業部**  
〒141-0032 東京都品川区大崎一丁目11番2号  
(ゲートシティ大崎イーストタワー)

URL <http://www.fujielectric.co.jp/>

発行 富士電機株式会社 鈴鹿工場  
〒513-8633 三重県鈴鹿市南玉垣町5520番地

技術相談窓口 TEL:0120-128-220 FAX:0120-128-230

**Fuji Electric Co., Ltd.**

Gate City Ohsaki, East Tower, 11-2, Osaki 1-chome,  
Shinagawa-ku, Tokyo, 141-0032, Japan

Phone: +81 3 5435 7283 Fax: +81 3 5435 7425

URL <http://www.fujielectric.com/>