



取扱説明書 / Instruction Manual

CANopen 通信カード
CANopen Communications Card
"OPC-COP2"

日本語

ENGLISH

English Version

ENGLISH

Preface

Thank you for purchasing our CANopen Communications Card "OPC-COP2".

Mounting this communications card on your inverter allows you to connect inverter to a CANopen master unit (e.g., PC and PLC) and control it as a slave unit using run commands, frequency commands, and access to function codes.

This communications card has the following features:

- Communications profile: DS 301 Ver. 4.02, DSP 402 Ver. 2.0 Velocity Mode
- Transmission speed: 20 kbit/s to 1 Mbit/s
- Maximum cabling length: 25 m (1 Mbit/s) to 2500 m (20 kbit/s)
- Reading and writing all the function codes supported by the inverter

This instruction manual does not contain inverter handling instructions. Read through this instruction manual in conjunction with the inverter Instruction Manual and be familiar with proper handling and operation of this product. Improper handling might result in incorrect operation, a short life, or even a failure of this product.

Keep this manual in a safe place.

Related Publications

Listed below are the other materials related to the use of the CANopen communications card "OPC-COP2". Read them in conjunction with this manual as necessary.

- RS-485 Communication User's Manual
- Inverter instruction Manual

The materials are subject to change without notice. Be sure to obtain the latest editions for use.

A figure, existence of a terminal, a function code, an alarm code, etc. which have been written in this manual may change with object inverters.

Listed below are the CANopen specifications published by CAN in Automation (CiA). It is recommended that the user of this communications card read them since this instruction manual is intended for the user who has a basic knowledge of CANopen.

- DS 301 Ver. 4.02
- DSP 402 Ver. 2.0

These specifications are available as a free download from the CiA website at:

<http://www.can-cia.de/>

ENGLISH



⚠ CAUTION

- Read through this instruction manual and be familiar with the CANopen communications card before proceeding with installation, connections (wiring), operation, or maintenance and inspection.
- Improper handling might result in incorrect operation, a short life, or even a failure of this product as well as the motor.
- Deliver this manual to the end user of this product. Keep this manual in a safe place until this product is discarded.

■ Safety precautions

Read this manual thoroughly before proceeding with installation, connections (wiring), operation, or maintenance and inspection. Ensure you have sound knowledge of the device and familiarize yourself with all safety information and precautions before proceeding to operate the inverter.

Safety precautions are classified into the following two categories in this manual.

 WARNING	Failure to heed the information indicated by this symbol may lead to dangerous conditions, possibly resulting in death or serious bodily injuries.
 CAUTION	Failure to heed the information indicated by this symbol may lead to dangerous conditions, possibly resulting in minor or light bodily injuries and/or substantial property damage.

Failure to heed the information contained under the CAUTION title can also result in serious consequences. These safety precautions are of utmost importance and must be observed at all times.

Installation and wiring

WARNING

- Before changing the switches, turn OFF the power and wait at least 10 minutes. Make sure that the charging lamp is turned OFF. Further, make sure, using a multimeter or a similar instrument, that the DC link bus voltage between the terminals P(+) and N(-) has dropped to the safe level (+25 VDC or below).
- Qualified electricians should carry out wiring.
Otherwise, an electric shock could occur.

CAUTION

- Do not use the product that is damaged or lacking parts.
Doing so could cause a fire, an accident, or injuries.
- Prevent lint, paper fibers, sawdust, dust, metallic chips, or other foreign materials from getting into the inverter and the communications card.
Otherwise, a fire or an accident might result.
- Incorrect handling in installation/removal jobs could cause a failure.
A failure might result.
- Noise may be emitted from the inverter, motor and wires. Implement appropriate measure to prevent the nearby sensors and devices from malfunctioning due to such noise.
Otherwise, an accident could occur.

Operation

WARNING

- Be sure to install the front cover before turning the inverter's power ON. Do not remove the cover when the inverter power is ON.
Otherwise, an electric shock could occur.
- Do not operate switches with wet hands.
Doing so could cause an electric shock.
- If you configure the function codes wrongly or without completely understanding inverter Instruction Manual and the inverter User's Manual, the motor may rotate with a torque or at a speed not permitted for the machine. Confirm and adjust the setting of the function codes before running the inverter.
Otherwise, an accident could occur.

Maintenance and inspection, and parts replacement

WARNING

- Before changing the switches, turn OFF the power and wait at least 10 minutes. Make sure that the charging lamp is turned OFF. Further, make sure, using a multimeter or a similar instrument, that the DC link bus voltage between the terminals P(+) and N(-) has dropped to the safe level (+25 VDC or below).
Otherwise, an electric shock could occur.
- Maintenance, inspection, and parts replacement should be made only by qualified persons.
- Take off the watch, rings and other metallic objects before starting work.
- Use insulated tools.
Otherwise, an electric shock or injuries could occur.

Disposal

CAUTION

- Treat the communications card as an industrial waste when disposing of it.
Otherwise injuries could occur.

Others

WARNING

- Never modify the communications card.
Doing so could cause an electric shock or injuries.

Icons

The following icons are used throughout this manual.

 **Note** This icon indicates information which, if not heeded, can result in the product not operating to full efficiency, as well as information concerning incorrect operations and settings which can result in accidents.

 **Tip** This icon indicates information that can prove handy when performing certain settings or operations.

 This icon indicates a reference to more detailed information.

Table of Contents

Preface	1	Chapter 8 SDO PROTOCOL	22
■ Safety precautions.....	1	8.1 About SDO	22
Chapter 1 BEFORE USING THE COMMUNICATIONS CARD.....	5	8.2 Response to Abnormal SDO Access	22
1.1 Acceptance Inspection	5	Chapter 9 OTHER CANopen COMMUNICATION FUNCTIONS.....	23
Chapter 2 NAMES AND FUNCTIONS.....	6	9.1 Overview	23
2.1 Parts Names.....	6	9.2 Other Services.....	23
2.2 CANopen Terminal Block (TERM1)	6	Chapter 10 LIST OF OBJECTS.....	25
2.3 LED Status Indicators	6	10.1 Objects in Communication Profile Area	25
Chapter 3 INSTALLATION AND REMOVAL OF THIS COMMUNICATIONS CARD	7	10.2 Objects in Fuji Specific Profile Area	29
3.1 Installing the Communications Card.....	7	10.3 Standard Device Profile Area	31
3.2 Removing the Communications Card.....	8	Chapter 11 DRIVING THE INVERTER VIA CANopen NETWORK	33
Chapter 4 WIRING AND CABLING	9	11.1 Driving with CANopen Drive Profile (DSP 402)	33
4.1 Basic Connection Diagram	9	11.2 Driving with Inverter's Function Code S06.....	38
4.2 Wiring for CANopen Terminal Block	10	Chapter 12 HEARTBEAT AND NODE-GUARDING.....	42
4.3 Wiring to Inverter	11	12.1 Heartbeat.....	42
Chapter 5 CONFIGURING INVERTER'S FUNCTION CODES FOR CANopen COMMUNICATION ..	12	12.2 Node Guarding	43
Chapter 6 ESTABLISHING A CANopen COMMUNICATIONS LINK	13	Chapter 13 INVERTER REACTIONS TO CANopen NETWORK BREAKS	44
Chapter 7 PDO PROTOCOL.....	15	Chapter 14 LIST OF INVERTER ALARM CODES	46
7.1 Overview	15	Chapter 15 NOTES ON USE OF COMMUNICATIONS CARD.....	49
7.2 Receive PDO (from master to inverter)	16	Chapter 16 SPECIFICATIONS	50
7.3 Transmit PDO (from inverter to master).....	18	16.1 Operating Environment.....	50
7.4 Communications Parameters in Receive PDO.....	19	16.2 CANopen Specifications	50
7.5 Communications Parameters in Transmit PDO	20		
7.6 Changing PDO mapping entry(RPDO/TPDO).....	21		

Chapter 1 BEFORE USING THE COMMUNICATIONS CARD

1.1 Acceptance Inspection

Unpack the package and check the following:

- (1) A communications card, two screws (M3 × 8), and the CANopen Communications Card Instruction Manual (this manual) are contained in the package.
- (2) The communications card is not damaged during transportation—no defective parts, dents or warps.
- (3) The model name "**OPC-COP2**" is printed on the communications card (see Figure 2.1).

If you suspect the product is not working properly or if you have any questions about your product, contact the shop where you bought the product or your local Fuji branch office.



Neither an EDS file nor a terminating resistor comes with this communications card.

- An EDS file is required for registering this communications card to the configurator designed for CANopen master node settings. It is available as a free download from our website at:

<https://felib.fujielectric.co.jp/download/limitedlogin.htm?site=global&lang=en>

Before downloading, you are requested to register as a member (free of charge). Search for "EDS" after login, and you can download the file for OPC-COP2.

- A terminating resistor of the following specifications must be used: 120 ohm ±1%, 1/4 watt, metal-film resistor

Chapter 2 NAMES AND FUNCTIONS

2.1 Parts Names

Figure 2.1 shows the names of the parts on the CANopen communications card.

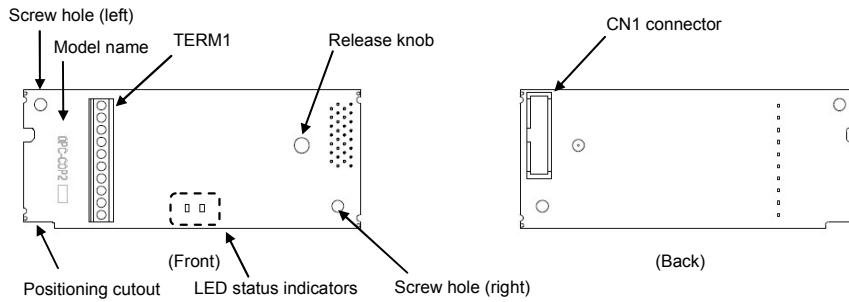



Figure 2.1 Names of Parts on CANopen Communications Card

2.2 CANopen Terminal Block (TERM1)

Connect the CANopen communications cable to the CANopen terminal block.

 For details about wiring, refer to Chapter 4 "WIRING AND CABLING".

2.3 LED Status Indicators

This communications card has two LED status indicators that indicate the operation status of the communications card as listed in Table 2.1.

Table 2.1 LED Status Indicators and Operation Status

LED	Status	Meaning
RUN (Green)	OFF	Powered off or communications error
	Single flash *1	"Stopped"
	Blinking *2	"Pre-Operational"
	ON	"Operational"
ERR (Red)	OFF	No communications error
	Single flash *1	"Bus state" is Error-passive.
	Double flash *3	Network break detected by Heartbeat or Node Guarding
	Blinking *2	Configuration error, Connection abnormality (e.g. Node ID (o31=0) has not been set) (e.g. Wrong connection between the communication card and the inverter)
	ON	"Bus state" is Bus-off. *4
Both RUN and ERR turn ON.		CPU error on the communications card. *5

*1 Single flash: In cycles of 200-ms ON and 1-second OFF.

*2 Blinking: At 2.5 Hz (in cycles of 200-ms ON and 200-ms OFF).

*3 Double flash: In cycles of 200-ms ON, 200-ms OFF, 200-ms ON, and 1-second OFF.

*4 The ERR LED might flash at an indefinite frequency.

*5 The inverter also detects "Er4" alarm when the access failure to the non-volatile memory that is mounted on this card occurs. Both RUN LED and ERR LED also turn ON in this case.

Chapter 3 INSTALLATION AND REMOVAL OF THIS COMMUNICATIONS CARD

WARNING

- Before changing the switches, turn OFF the power and wait at least 10 minutes. Make sure that the charging lamp is turned OFF. Further, make sure, using a multimeter or a similar instrument, that the DC link bus voltage between the terminals P(+) and N(-) has dropped to the safe level (+25 VDC or below).
Otherwise, an electric shock could occur.

CAUTION

- Do not use the product that is damaged or lacking parts.
Doing so could cause a fire, an accident, or injuries.
- Prevent lint, paper fibers, sawdust, dust, metallic chips, or other foreign materials from getting into the inverter and the communications card.
Otherwise, a fire or an accident might result.
- Incorrect handling in installation/removal jobs could cause a failure.
A failure might result.

3.1 Installing the Communications Card

 **Note** Before mounting the communications card, perform the wiring for the main circuit terminals and control circuit terminals.

- (1) Remove the front cover from the inverter and expose the control printed circuit board (control PCB). The communications card can be connected to the option connection ports on the inverter's control PCB. In some inverter models, an option attachment is required for mounting the communications card.

 **Note** Check the user's manual of an inverter about the connection port of the communications card.

 To remove the front cover, refer to the inverter Instruction Manual, "WIRING".

- (2) Insert connector CN1 on the back of the communications card (Figure 2.1) into the option connection ports. Then secure the communications card with the two screws that come with the card. (Figure 3.2)

 **Note** Check that the positioning cutout (shown in Figure 2.1) is fitted on the tab (① in Figure 3.1) and connector CN1 is fully inserted (② in Figure 3.1). Figure 3.2 shows the communications card correctly mounted.

 **Note** Some inverter models require an option attachment to install this communications card on it. Please refer to the instruction manual about the wiring to the option attachment.

- (3) Perform wiring to the communications card.

 For details, refer to Chapter 4 "WIRING AND CABLING."

- (4) Put the front cover back into place.

 To put back the front cover, refer to the inverter Instruction Manual, "WIRING".

ENGLISH

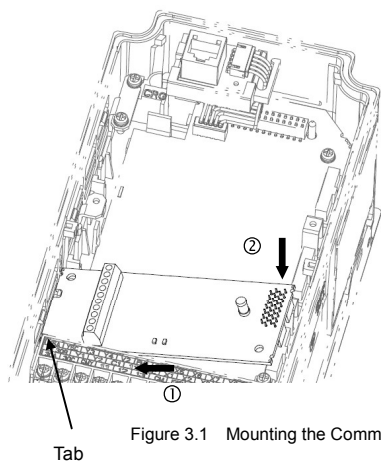

- ① Fit the positioning cutout of the communications card over the tab on the inverter to determine the mounting position.
- ② Insert connector CN1 on the communications card into the option connection ports on the inverter's control PCB.

Note: Be sure to follow the order of ① and ②. Inserting CN1 first may lead to insufficient insertion, resulting in a contact failure.

Figure 3.1 Mounting the Communications Card (to FRENIC-MEGA A-port)

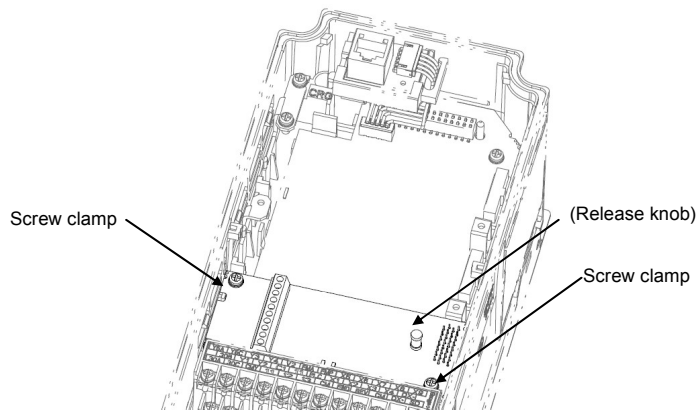

Figure 3.2 Mounting Completed (on FRENIC-MEGA A-port)

3.2 Removing the Communications Card

Remove the two screws that secure the communications card and pull the release knob (shown above) to take the communications card out of the inverter.

Chapter 4 WIRING AND CABLING

⚠ WARNING ⚠

- Before changing the switches, turn OFF the power and wait at least 10 minutes. Make sure that the charging lamp is turned OFF. Further, make sure, using a multimeter or a similar instrument, that the DC link bus voltage between the terminals P(+) and N(-) has dropped to the safe level (+25 VDC or below).
- Qualified electricians should carry out wiring.
Otherwise, an electric shock could occur.
- In general, the covers of the control signal wires are not specifically designed to withstand a high voltage (i.e., reinforced insulation is not applied). Therefore, if a control signal wire comes into direct contact with a live conductor of the main circuit, the insulation of the cover might break down, which would expose the signal wire to a high voltage of the main circuit. Make sure that the control signal wires will not come into contact with live conductors of the main circuit.
Failure to observe this precaution could cause an electric shock or an accident.

⚠ CAUTION ⚠

Noise may be emitted from the inverter, motor and wires. Take appropriate measures to prevent the nearby sensors and devices from malfunctioning due to such noise.
An accident could occur.

4.1 Basic Connection Diagram

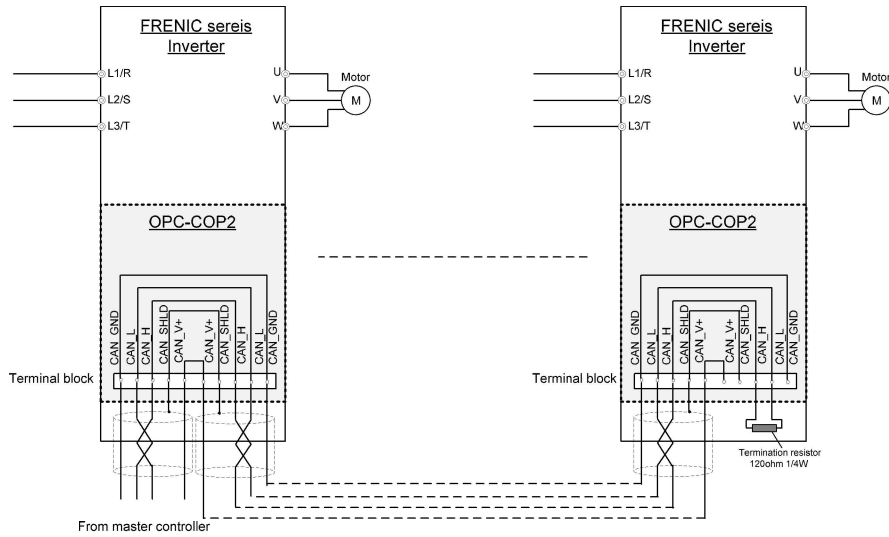

- CAN_SHLD This wire is not connected to the internal circuit on the communications card. Perform functional grounding if necessary.
- CAN_V+ This wire is not connected to the internal circuit on the communications card. No output voltage is applied to this wire.

Figure 4.1 Basic Connection Diagram

ENGLISH

4.2 Wiring for CANopen Terminal Block

(1) CANopen terminal block (TERM1)

The pin assignment of the CANopen terminal block (TERM1) is shown in Figure 4.2 and Table 4.1.

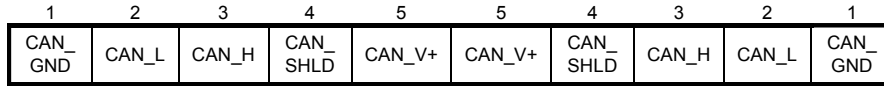

Figure 4.2 Pin Assignment on CANopen Terminal Block



Please take note of the terminal configuration, because it is different from the "OPC-COP". The CANopen devices might be damaged when the wiring is not correct. (not only this product but also the other devices connected to CAN bus)

Table 4.1 Functions of CANopen Terminals

Pin #	Name	Description
1	CAN_GND	Signal ground
2	CAN_L	CAN L bus line
3	CAN_H	CAN H bus line
4	CAN_SHLD *1	Terminal for connecting the cable shield
5	CAN_V+ *2	NC

*1 This terminal is not connected to the internal circuit on the communications card. Perform functional grounding if necessary.

*2 This terminal is not connected to the internal circuit on the communications card. No output voltage is applied to this terminal.

(2) CANopen communications cable

To connect the communications card to CANopen network, be sure to use a CANopen dedicated cable. The maximum cabling length is listed below.

Table 4.2 Maximum Cabling Length for CANopen Communication

Baud rate (bit/s)	20 k	50 k	125 k	250 k	500 k	800 k	1 M
Maximum cabling length	2500 m	1000 m	500 m	250 m	100 m	50 m	25 m

(3) Wiring to CANopen terminal block

Before connecting the CANopen communications cable to the terminal block, strip the wire ends as specified in Figure 4.3 and twist the core and shield wires. Figure 4.4 shows the recommended terminal screw size and its tightening torque.

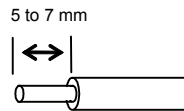

Figure 4.3 Strip Length of the CANopen Cable Wire End

Screw size: M2
Tightening torque: 0.19: N·m

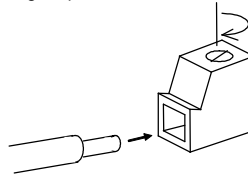

Figure 4.4 Connecting Wire to CANopen Terminal Block

(4) Terminating resistor



When the communications card is mounted on the inverter at either end of the network, insert the terminating resistor specified below between terminal pins #2 (CAN_L) and #3 (CAN_H).

120Ω ±1%, 1/4 W



Terminating resistor is not included with this communications card.

4.3 Wiring to Inverter

-  Note Route the wiring of the CANopen communications cable as far from the wiring of the main circuit as possible. Otherwise electric noise may cause malfunctions.
-  Note Route the wires, taking care not to let them go over the control PCB, malfunctions may occur.
-  Note Some inverter models require an option attachment to install this communications card on it. Please refer to the instruction manual about the wiring of the option attachment.

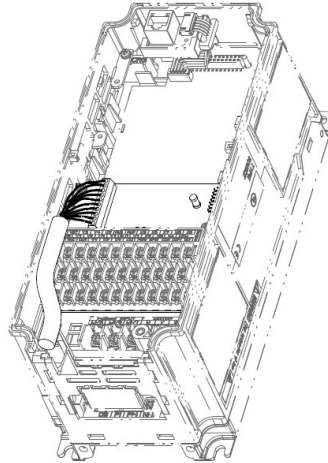

* Pass the wires from the communications card between the control circuit terminal block and the front cover.

In the case of FRENIC-MEGA 0.4 kW

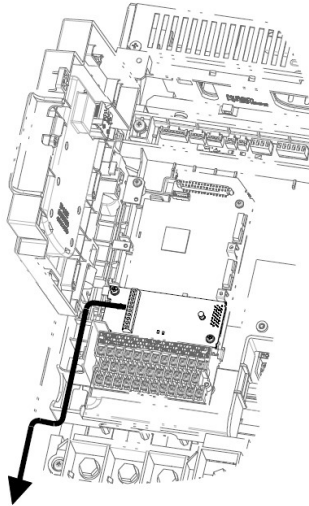

In the case of FRENIC-MEGA 75 kW

Figure 4.5 Examples of Wiring

Chapter 5 CONFIGURING INVERTER'S FUNCTION CODES FOR CANopen COMMUNICATION

To perform data transmission between the inverter equipped with this communications card and the CANopen master, configure the function codes listed in Table 5.1.

Table 5.2 lists inverter's function codes related to CANopen communication. Configure those function codes if necessary.

Table 5.1 Inverter's Function Code Settings Required for CANopen Communication

Function codes	Description	Factory default setting	Function code data	Remarks															
o31 *1	Specify Node-ID (station address)	0	0 to 255 (Specify any of 0 to 127.)	Setting 0 or 128 or greater is regarded as 127.															
o32 *2	Specify baud rate	0	0 to 255 (Specify any of 0 to 7.) 0: 125 kbit/s 1: 20 kbit/s 2: 50 kbit/s 3: 125 kbit/s 4: 250 kbit/s 5: 500 kbit/s 6: 800 kbit/s 7: 1 Mbit/s 8 or above: 1 Mbit/s	The baud rate specified here should be consistent with that of the master node.															
y98 *3	Select run/frequency command source	0	Available data is: <table border="1" style="margin-left: 20px;"> <thead> <tr> <th></th> <th>Frequency command</th> <th>Run command</th> </tr> </thead> <tbody> <tr> <td>0</td> <td>Inverter</td> <td>Inverter</td> </tr> <tr> <td>1</td> <td>CANopen</td> <td>Inverter</td> </tr> <tr> <td>2</td> <td>Inverter</td> <td>CANopen</td> </tr> <tr> <td>3</td> <td>CANopen</td> <td>CANopen</td> </tr> </tbody> </table>		Frequency command	Run command	0	Inverter	Inverter	1	CANopen	Inverter	2	Inverter	CANopen	3	CANopen	CANopen	If there is no special problem with your system, y98 = 3 is recommended.
	Frequency command	Run command																	
0	Inverter	Inverter																	
1	CANopen	Inverter																	
2	Inverter	CANopen																	
3	CANopen	CANopen																	

*1 After configuring the function code o31, turn the inverter power OFF and then ON or issue ResetNode from the CANopen master to the communications card to validate the new settings.

*2 After configuring the function code o32, turn the inverter power OFF and then ON to validate the new setting.

*3 In addition to y98, the **inverter** has other function codes related to the run/frequency command source. Configuring those codes realizes more precise selection of the command sources. For details, refer to the descriptions of H30 and y98 in the **inverter** Instruction Manual, "FUNCTION CODES".

Table 5.2 Other Related Function Codes

Function codes	Description	Factory default setting	Function code setting range	Remarks
o27	Select the inverter's operation mode to apply when a CANopen communications error occurs.	0	0 to 15	Refer to Chapter 13
o28	Set the operation timer to apply when a CANopen communications error occurs.	0.0 s	0.0 s to 60.0 s	Refer to Chapter 13
o40 to o43 *1	Specify the function code to be assigned to TPDO 3 (for write).	0 (No assignment)	0000 to FFFF (hex)	These settings are used in PDO 3.
o48 to o51 *1	Specify the function code to be assigned to RPDO 3 (for readout).	0 (No assignment)	0000 to FFFF (hex)	

*1 For details about how to configure the function codes o40 to o43 and o48 to o51, refer to Chapter 7, Section 7.2. (4) "Configuring inverter's function codes o40 to o43, o48 to o51, and Indexes 5E00 and 5E01".

After configuring them, turn the inverter power OFF and then ON or issue ResetNode from the CANopen master to the communications card to validate the new settings.

Chapter 6 ESTABLISHING A CANopen COMMUNICATIONS LINK

This chapter guides you to establish a CANopen communications link between the CANopen master and this communications card mounted on the inverter (slave node).

Follow the steps below.

- Step 1** Configuring the CANopen master equipment
- Step 2** Specifying the Node-ID and the baud rate of the communications card, using inverter's function codes
- Step 3** Restarting the inverter ⇒ Pre-Operational state
- Step 4** Setting a link break detector object (Heartbeat or Node Guarding)
- Step 5** Sending a Start Remote Node command from the master node equipment to the communications card ⇒ Operational state

Each of the above steps is detailed below.

Step 1 Configuring the CANopen master equipment

- Specify the master Node-ID and baud rate.
- Register the communications card to the master node using the EDS file prepared for the communications card.

 For details about the configuration of the CANopen master equipment, refer to the user's manual or documentations of your master equipment.

 **Note** An EDS file, which is required for registering the CANopen communications card to the CANopen master, does not come with the communications card. It is available as a free download from our website at:

<https://felib.fujielectric.co.jp/download/limitedlogin.htm?site=global&lang=en>

Before downloading, you are requested to register as a member (free of charge).

Search for "EDS" after login, and you can download the file for OPC-COP2.

Step 2 Specifying the Node-ID and the baud rate of the communications card, using inverter's function codes

- Specify the Node-ID and baud rate of the communications card using o31 and o32, respectively. Those settings should match the ones specified for the master node.
- Configure inverter's function codes o27 and o28, if needed.

 For details about function codes o27 and o28, refer to Chapter 13 "INVERTER REACTIONS TO CANopen NETWORK BREAKS".

Step 3 Restarting the inverter ⇒ Pre-Operational state

Restarting the inverter automatically goes to the Pre-Operational state in which it is ready to communicate with the CANopen master if the master and the inverter are correctly configured and wired to the network.

LED status indicators on the communications card in the Pre-Operational state: The green RUN LED flashes and the red ERR LED is OFF or flashes.

Step 4 Setting a link break detector object (Heartbeat or Node Guarding)

To detect a link break, enable either Heartbeat or Guarding on both the master node and the communications card.

 For details about the configuration of the Heartbeat and Node Guarding, refer to Chapter 12.



At the factory, CANopen devices are so set up that their link break detectors are disabled. Unless the user enables the link break detector, the CANopen network including the communications card does not detect a communications link break if any. It is strongly recommended to enable the link break detector.

Step 5 Sending a Start Remote Node command from the master node equipment to the communications card ⇒ Operational state

Upon receipt of the Start Remote Node command, the communications card turns the green RUN LED ON and switches to the Operational state. Accordingly, the master node can control or monitor the inverter in real time via PDO transmission.

 For data format of the PDO transmission, refer to Chapter 7 "PDO PROTOCOL".

Chapter 7 PDO PROTOCOL

7.1 Overview

The PDO (Process Data Object) protocol is used for communicating the process data between the CANopen master and inverter periodically (e.g.: running command, speed monitoring). This communications card supports the receive PDO (RPDO: from master to inverter) and transmit PDO (TPDO: from inverter to master) described in Table 7.1 and Table 7.2 respectively.

Table 7.1 Receive PDOs (RPDOs: from master to inverter)

PDO No.	Default COB-ID	Used to:
1	0x200 + Node-ID	Control the state change of DS-402
2	0x300 + Node-ID	Control the state change of DS-402 and the speed command
3	0x400 + Node-ID	Write four types of mapped inverter function codes

Table 7.2 Transmit PDOs (TPDOs: from Inverter to master)

PDO No.	Default COB-ID	Used to:
1	0x180 + Node-ID	Control the state transition in DS-402.
2	0x280 + Node-ID	Control the state transition and issue a speed command in DS-402.
3	0x380 + Node-ID	Read four types of mapped inverter function codes

- Note** Flexible mapping is supported
No.1 to 2 of RPDO and No.1 to 2 of TPDO can be remapped (No.3 does not support this feature). For more information, refer to "7.6 Changing PDO mapping entry (RPDO/TPDO)".
- Note** Transfer timing of transmit PDO
The factory default is "change of state event". For more information, refer to "7.5 Communications Parameters in Transmit PDO", "(3) Transmission type".
- Note** Enable/disable setting of PDO
All PDOs are enabled by factory default. Set the bit 31 in the COB-ID of each PDO to one in order to disable the PDO (no response).
- Tip** The PDO protocol is available only in the Operational state.

7.2 Receive PDO (From master to inverter)

(1) Receive PDO 1

COB-ID	Byte	Mapped object (default)			Re-map
		Object	Sub	Description	
0x200+Node ID	0-1	0x6040	0x00	Controlword	Yes
	2-3	-	-	None	Yes
	4-5	-	-	None	Yes
	6-7	-	-	None	Yes

 For details about the Controlword and DSP 402 state machine, refer to Chapter 11, Section 11.1 "Driving with CANopen Drive Profile (DSP 402)".

(2) Receive PDO 2

COB-ID	Byte	Mapped object (default)			Re-map
		Object	Sub	Description	
0x300+Node ID	0-1	0x6040	0x00	Controlword	Yes
	2-3	0x6042	0x00	v1 target velocity (r/min)	Yes
	4-5	-	-	None	Yes
	6-7	-	-	None	Yes

 For details about the Controlword, v1 control effort, and DSP 402 state machine, refer to Chapter 11, Section 11.1 "Driving with CANopen Drive Profile (DSP 402)".

 **Note** In case of providing the speed command in (r/min) unit, set the number of motor poles (P01/A15) properly according to the applicable motor; otherwise the speed command (r/min) will be incorrect.

(3) Receive PDO 3

This format is for constantly writing data of function codes (up to four) previously specified by inverter's function codes o40 to o43.

COB-ID	Byte	Mapped object			Re-map
		Object	Sub	Description	
0x400+Node ID	0-1	0x5E02	0x01	Writing function code 1 (function code data specified by o40)	No
	2-3	0x5E02	0x02	Writing function code 2 (function code data specified by o41)	No
	4-5	0x5E02	0x03	Writing function code 3 (function code data specified by o42)	No
	6-7	0x5E02	0x04	Writing function code 4 (function code data specified by o43)	No

 For details about the function codes o40 to o43, refer to the next item (4) "Configuring inverter's function codes o40 to o43, o48 to o51, and Indexes 5E00 and 5E01".

 For details about the data format of function codes assigned, refer to the RS-485 Communication User's Manual, Chapter 5, Section 5.2 "Data Formats".

 **Note** If the same function code is assigned to more than one out of o40 to o43 codes, only the one assigned to the smallest "o" code number becomes effective, and all the rest will be treated as "not assigned". For example, if the same function code is assigned to o40 and o43, o40 becomes effective and o43 does not.



Once you have modified the o40 to o43 data, be sure to restart the inverter or issue Reset Node from the CANopen master to the inverter to validate the new settings.



Object's Index 5E00 Sub 1 to 4 can also assign inverter's function codes. Those assignments immediately take effect. Note that restarting the inverter or issuing Reset Node to the inverter reverts those assignments to the ones made by o40 to o43.



The reflection timing of individual receive PDOs can be modified. Refer to Section 7.4, (3) "Transmission type". The factory default timing is to reflect to the inverter immediately after receipt of PDO."

(4) Configuring inverter's function codes o40 to o43, o48 to o51, and Indexes 5E00 and 5E01

The function code type (shown in Table 7.3) and number is specified by a 4-digit hexadecimal notation. However, when the function code does not exist in the inverter, it is ignored.

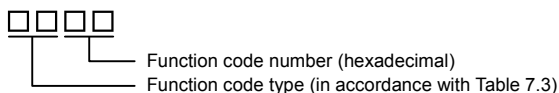

Table 7.3 Function Code Type

Type	Group code	Type	Group code	Type	Group code
—	—	W	0x10 (16)	H1	0x20 (32)
—	—	X	0x11 (17)	o1	0x21 (33)
S	0x02 (2)	Z	0x12 (18)	U1	0x22 (34)
M	0x03 (3)	b	0x13 (19)	M1	0x23 (35)
F	0x04 (4)	d	0x14 (20)	J1	0x24 (36)
E	0x05 (5)	—	—	J2	0x25 (37)
C	0x06 (6)	—	—	J3	0x26 (38)
P	0x07 (7)	W1	0x17 (23)	J4	0x27 (39)
H	0x08 (8)	W2	0x18 (24)	J5	0x28(40)
A	0x09 (9)	W3	0x19 (25)	J6	0x29(41)
o	0x0A (10)	X1	0x1A (26)	d1	0x2A (42)
L	0x0B (11)	X2	0x1B (27)		
r	0x0C (12)	Z1	0x1C (28)		
U	0x0D (13)	K	0x1D (29)		
J	0x0E (14)	T	0x1E (30)		
y	0x0F (15)	E1	0x1F (31)		

Example: For F26: F ⇒ Type code 04
 26 ⇒ 1A (hexadecimal) } 041A

7.3 Transmit PDO (From inverter to master)

(1) Transmit PDO 1

COB-ID	Byte	Mapped object (default)			Re-map
		Object	Sub	Description	
0x180+Node ID	0-1	0x6041	0x00	Statusword	Yes
	2-3	-	-	None	Yes
	4-5	-	-	None	Yes
	6-7	-	-	None	Yes

 For details about the Statusword, refer to Chapter 11, Section 11.1 "Driving with CANopen Drive Profile (DSP 402)".

(2) Transmit PDO 2

COB-ID	Byte	Mapped object (default)			Re-map
		Object	Sub	Description	
0x280+Node ID	0-1	0x6041	0x00	Statusword	Yes
	2-3	0x6044	0x00	vl control effort(r/min)	Yes
	4-5	-	-	None	Yes
	6-7	-	-	None	Yes

 For details about the Statusword and vl control effort, refer to Chapter 11, Section 11.1 "Driving with CANopen Drive Profile (DSP 402)".

(3) Transmit PDO 3

This format is for constantly reading out data from function codes (up to four) previously specified by inverter's function codes o48 to o51.

COB-ID	Byte	Mapped object			Re-map
		Object	Sub	Description	
0x380+Node ID	0-1	0x5E03	0x01	Reading function code 1 (function code data specified by o48)	No
	2-3	0x5E03	0x02	Reading function code 2 (function code data specified by o49)	No
	4-5	0x5E03	0x03	Reading function code 3 (function code data specified by o50)	No
	6-7	0x5E03	0x04	Reading function code 4 (function code data specified by o51)	No

 For details about the function codes o48 to o51, refer to Section 7.2 (4) "Configuring inverter's function codes o40 to o43, o48 to o51, and Indexes 5E00 and 5E01".

 For details about the data format of function codes assigned, refer to the RS-485 Communication User's Manual, Chapter 5, Section 5.2 "Data Formats".

 **Note** Once you have modified the o48 to o51 data, be sure to restart both the inverter and the communications card or issue ResetNode from the CANopen master to the inverter to validate the new settings.

 **Tip** Object's Index 5E01 Sub 1 to 4 can also assign inverter's function codes. The assignment immediately takes effect. Note that restarting the inverter or issuing ResetNode to the inverter reverts to the assignment made by o48 to o51.

 **Tip** The transmission timing of individual transmit PDOs can be modified. Refer to Section 7.5, (3) "Transmission type". The factory default timing is to transmit a PDO to the CANopen master every time the parameter value changes or at the time specified by the Event timer.

7.4 Communications Parameters in Receive PDO

(1) Communications parameters

The communications parameters specify the attributes of each receive PDO (RPDO). Table 7.3 lists the RPDOs available.

Table 7.4 Communications Parameters in Receive PDO (RPDO) and Their Defaults

Index	Sub	Parameter	Description
0x1400 RPDO 1 0x1401 RPDO 2 0x1402 RPDO 3	1	COB-ID	Specifies the CAN ID value and enables/disables the PDO. Default: RPDO 1: 0x200 + Node-ID RPDO 2: 0x300 + Node-ID RPDO 3: 0x400 + Node-ID
	2	Transmission type	Specifies the reflection timing of RPDO contents. Default: 255 (reflect to the inverter immediately after receipt of PDO).

(2) COB-ID

This parameter specifies an 11-bit ID value of communication object identifier of each PDO. The default value varies depending upon the Node-ID. If the Node-ID of the communications card is for example "1", the COB-ID of RPDO 2 is 0x301. Writing "1" to the most significant bit (bit 31) disables the RPDO.

 **Note** The COB-ID can be modified only when the PDO is disabled.

 **Tip** The CAN ID value is 11 bits long. Bits 11 through 30 are fixed to "0."

(3) Transmission type

The transmission type in an RPDO specifies the reflection timing of the RPDO contents to the inverter. Table 7.5 lists the transmission types available.

Table 7.5 Transmission Types Available in Receive PDO (RPDO)

Transmission type	Type name	Operation
0	Acyclic Synchronous	Reflect to the inverter upon receipt of a single Sync signal after receipt of the PDO.
1 to 240	Cyclic Synchronous	Same as above.
241 to 251	Reserved.	---
252	Synchronous RTR only	Disable *
253	Asynchronous RTR only	Disable *
254	Asynchronous 1	Reflect to the inverter immediately after receipt of PDO.
255	Asynchronous 2	Same as above. (Default)

* The communications card does not support CAN Remote Frames.

7.5 Communications Parameters in Transmit PDO

(1) About communication parameters

The communications parameters specify the attributes of each transmit PDO (TPDO). Table 7.6 lists the TPDOs available.

Table 7.6 Communications Parameters in Transmit PDO (TPDO) and Their Defaults

Index	Sub	Name	Description
0x1800 TPDO 1 0x1801 TPDO 2 0x1802 TPDO 3	1	COB-ID	Specifies the CAN ID value and enables/disables the PDO. Default: TPDO 1: 0x180 + Node-ID TPDO 2: 0x280 + Node-ID TPDO 3: 0x380 + Node-ID
	2	Transmission type	Specifies the transmission timing (see Table 7.7). Default: 255 (transmit every time data changes).
	3	Inhibit time	Specifies the minimum interval (in units of 0.1 ms) for PDO transmission. Default: 100 (10.0 ms)*
	5	Event timer	Specifies the cyclic interval (ms) for PDO transmission, which takes effect in transmission type 254 or 255. Default: 0 (Disable)

* The minimum timer resolution is 1ms. So the setting value lower than 1ms is rounded up according to this minimum resolution.
e.g. 11.1ms of setting value is treated as 12ms.

(2) COB-ID

This parameter specifies an 11-bit ID value of communication object identifier of each PDO. The default value varies depending upon the Node-ID. If the Node-ID of the communications card is for example "1", the COB-ID of TPDO 2 is 0x281. Writing "1" to the most significant bit (bit 31) disables the TPDO.

Note Only when the PDO is disabled, its COB-ID value can be modified.

Tip The CAN ID value is 11 bits long. Bits 11 through 30 are fixed to "0."

(3) Transmission type

The transmission type in a TPDO specifies the transmission timing of the PDO to the CANopen master. Table 7.7 lists the transmission types available.

Table 7.7 Transmission Types Available in Transmit PDO (TPDO)

Transmission type	Type name	Operation
0	Acyclic Synchronous	Transmit a PDO upon receipt of a Sync signal if data has changed.
1 to 240	Cyclic Synchronous	Transmit a PDO every time the inverter receives a Sync signal by the specified times (1 to 240 times). Example: Specification of 10 transmits a PDO every time the inverter receives a Sync signal 10 times.
241 to 251	Reserved.	---
252	Synchronous RTR only	Disable *
253	Asynchronous RTR only	Disable *
254	Asynchronous 1	Transmit a PDO at the intervals specified by Event timer.
255	Asynchronous 2	Transmit a PDO every time data changes and at the time specified by Event timer.

* The communications card does not support CAN Remote Frames.

(4) Inhibit time

This parameter specifies the minimum interval (in units of 0.1 ms) for PDO transmission. It has priority over the transmission type settings.

Note The inhibit time can be modified only when the PDO is disabled, that is, bit 31 of the COB-ID is "1".

Note Specifying a too small value to the inhibit time increases the frequency of data transmission, resulting in a lot of CANopen network traffic. It may degrade the performance of the overall CANopen network. Adjust the inhibit time setting properly according to your network configuration.

(5) Event timer

This parameter specifies the cyclic interval (in units of 1 ms) for PDO transmission, which takes effect in transmission type 254 or 255.

7.6 Changing PDO mapping entry (RPDO/TPDO)

Follow the procedure below to change mapping entries:

- (1) Disable the PDO by changing the bit 31 of the relevant COB-ID entry to "1".

Example) RPDO: Index 0x1400, Subindex 1, Bit31 = 1
TPDO: Index 0x1800, Subindex 1, Bit31 = 1

- (2) Disable the PDO mapping by writing 0h in the sub index 0h of the relevant mapping entry.

Example) RPDO: Disable the current mapping and set Index 0x1600, Subindex 0 = 0.
TPDO: Disable the current mapping and set Index 0x1A00, Subindex 0 = 0.

- (3) Configure the target new PDO mapping.

Example) RPDO: Index 0x1600, Subindex 1 through 4 = New object
TPDO: Index 0x1A00, Subindex 1 through 4 = New object
Setting format Object index(2 byte) + Sub index (1 byte) + Bit length (1 byte)

Tip e.g.) To specify "vi velocity min amount"(Object 6046 Sub1) to target PDO

Object index (Hex)	Sub index(Hex)	Bit length(Hex)
60	46	01
		20 *

* "Data type" attribute of "vi velocity min amount" is [UNSIGNED32].
In accordance with this attribute, set "Bit length" to 32 (hexadecimal 0x20).
Setting value is [0x60,0x46,0x01,0x20]

Note Bit total (Subindex 1 to 4) number of 1PDO is up to a maximum of 64bit.

Tip Please select a mapping object of [Standard Device Profile Area].
(Refer to "Map" columns of [10.3 Standard Device Profile Area])

- (4) Set the sub index 0h of the relevant mapping index to the number of objects to be mapped (n).

Example) RPDO: Index 0x1600, Subindex 0 = n
TPDO: Index 0x1A00, Subindex 0 = n

- (5) Enable the PDO by changing the bit 31 of the relevant COB-ID entry to "0".

Example) RPDO: Index 0x1400, Subindex 1, Bit31 = 0
TPDO: Index 0x1800, Subindex 1, Bit31 = 0

Chapter 8 SDO PROTOCOL

8.1 About SDO

The Service Data Object (SDO) protocol is used to configure or adjust the communications card. The SDO allows access to all objects (parameters) of the communications card.

The communications card supports a single Server SDO.

 For details about the SDO transfer procedure, refer to the user's manuals or documentations of your master equipment or configuration tools.

 For details about the objects, Chapter 10 "LIST OF OBJECTS".

8.2 Response to Abnormal SDO Access

If an access to the communications card using the SDO is abnormal, the communications card responds to it with Abort codes listed below.

Table 8.1 Abort Codes for Abnormal SDO Access

Abort codes	Description
0503 0000	Error in segmented transfer: Toggle bit not toggled.
0504 0000	SDO timed out.
0601 0001	Read request on write-only parameter.
0601 0002	Write request on read-only parameter.
0602 0000	Object does not exist.
0604 0041	Object cannot be mapped to the PDO.
0604 0042	The number and length of the objects to be mapped would exceed PDO length.
0606 0000	Access failed due to a H/W error.
0607 0010	Data type unmatched.
0607 0012	Data type does not match; length of service parameter too high.
0607 0013	Data type does not match; length of service parameter too low.
0609 0011	Sub-index does not exist.
0609 0030	Attempted to write a value out of range.
0609 0031	Value of parameter written too high.
0609 0032	Value of parameter written too low.
0800 0020	Data cannot be transferred or stored to the application.
0800 0021	Error in writing into an inverter's function code (attempted to write into S01, S05, or S06 via CANopen network when the RS-485 communications link of the inverter exists).
0800 0022	Not allowed to write into an inverter's function code (when the inverter is running or writing, or when any digital input terminal is ON).

Chapter 9 OTHER CANopen COMMUNICATION FUNCTIONS

9.1 Overview

Table 9.1 overviews the CANopen communication functions of the communications card.

Table 9.1 CANopen Communication Functions of Communications Card

Item	Contents supported	Refer to:
Communications profile	- DS 301 Ver. 4.02 compliant - DSP 402 Ver. 2.0 Velocity Mode compliant	--
PDO	- Supports three PDOs each for receive and transmit - No.1 to 2 of RPDO and No.1 to 2 of TPDO can be remapped.	Chapter 7
SDO	- Supports a single Server SDO.	Chapter 8
Other services provided	- Network Management (NMT) Start_Remote_Node, Stop_Remote_Node, Enter_Pre-Operational, and Reset_Communication, and Reset_Node - Heartbeat (Producer and Consumer) - Node Guarding - Emergency (EMCY)	Section 9.2

9.2 Other Services

(1) Network management (NMT)

The NMT controls the DS 301 state machine. Upon receipt of the NMT services, the communications card operates as listed below.

表 9.2 Communications Card Operation Upon Receipt of NMT Services

Service	Behavior on reception	Remarks
Start_Remote_Node	Switches to the Operational state.	Communication with PDO is valid only in Operational state.
Stop_Remote_Node	Switches to the Stopped state.	In the Stopped state, transmission of NMT services only is possible.
Enter_Pre-Operational Reset_Communication	Switches to the Pre-Operational state.	In the Pre-Operational state, PDO transmission is not possible.
Reset_Node	Initializes itself to the restarted state.	The communications card reads the Node-ID and o40 to o51 data.

 For details about the NMT, refer to the user's manual or documentations of your master equipment, or CANopen Specifications DS 301 published by CiA.

(2) Heartbeat and Node Guarding

Heartbeat and Node Guarding are services for detecting network breaks. The implementation of either Heartbeat or Node Guarding is recommended.

 For details about Heartbeat and Node Guarding, refer to Chapter 12 "Heartbeat and Node Guarding".

 CAUTION
<p>Important: The use of either Heartbeat or Node Guarding is recommended</p> <p>The setting for detecting disconnection in the CANopen device is invalid by default. Unless the setting is enabled, the CANopen network including inverter can not detect a disconnection even if the disconnection occurs. We strongly recommend to enable the setting.</p>

ENGLISH

(3) Emergency (EMCY)

This service allows the communications card to automatically transmit the content of an alarm that has occurred in the inverter. The transmission format is shown below.

COB-ID	Byte 0	Byte 1	Byte 2	Byte 3	Byte 4	Byte 5	Byte 6	Byte 7
0x80 + Node-ID	Error field (L byte) (H byte)		Error register	0	0	0	0	0

Error field: Content of an alarm that has occurred

Error register: 1 = An alarm has occurred, 0 = No alarm
(Functionally equivalent to Index 1001)

 For details about [Error field] and [alarm codes], refer to "Chapter 14 CODES".

LIST OF INVERTER ALARM

Chapter 10 LIST OF OBJECTS

This chapter describes objects (parameters) supported by the communications card. They are contained in any of the following three areas.

- (1) Communication Profile Area (Indexes 1000 to 1FFF)
This contains a group of objects common to all CANopen communications devices. It is stipulated in the CANopen Specifications DS 301.
- (2) Manufacturer Specific Profile Area (Indexes 2000 to 5FFF)
This contains a group of objects exclusively designed for Fuji products and not compatible with other manufacturers' CANopen devices. It enables access to inverter's function codes.
- (3) Standard Device Profile Area (Indexes 6000 to 9FFF)
This contains a group of objects that allow the control of the inverters. It is standardized by the CANopen Specifications DSP 402 and is compatible with other manufacturers' CANopen devices.

10.1 Objects in Communication Profile Area

Table 10.1 lists objects in the communication profile area.

R/W: Object access type. "R": denotes Read-only "RW": Read/Write
S/R: "Y" Indicates the object which is affected by object 1010/1011(Store/Restore)

(1) Communication Profile Area

Table 10.1 Objects in Communication Profile Area

Index (Hex)	Sub	Object name	Description	Data type	R/W	S/R
1000	-	Device type	0x10192	UNSIGNED32	R	
1001	-	Error register	1: Error, 0: No error	UNSIGNED8	R	
1003	-	Pre-defined error field		ARRAY	-	
	0	Number of errors	Number of errors that have occurred. 1: One error, 0: No error [Write]0:error field reset.	UNSIGNED8	RW	
	1	Standard error field	Codes of errors that have occurred. (See Table 14.1.)	UNSIGNED32	R	
1005	-	COB-ID SYNC	COB-ID of SYNC message Default: 0x080	UNSIGNED32	RW	Y
1008	-	Manufacturer device name	Device name: OPC-COP2	STRING	R	
1009	-	Manufacturer HW version	Hardware version	STRING	R	
100A	-	Manufacturer SW version	Software version	STRING	R	
100C	-	Guard time	Node guarding time (ms) Default: 0 (Disable)	UNSIGNED16	RW	Y
100D	-	Life time factor	Guarding time factor (Multiplying the guard time by this factor gives the life time for this node.) Default: 0 (Disable)	UNSIGNED8	RW	Y
1014	-	COB-ID EMCY	COB-ID of EMCY message Readout value: 0x080 + Node-ID	UNSIGNED32	R	
1016	-	Consumer heartbeat time		ARRAY		
	0	Number of entries	Structures: 1	UNSIGNED8	R	
	1	Consumer heartbeat time	Upper word: Node-ID of Heartbeat producer Lower word: Heartbeat monitor cycle Default: 0 (Disable)	UNSIGNED32	RW	Y
1017	-	Producer heartbeat time	Cycle time (ms) of Heartbeat message transmission Default: 0 (Disable)	UNSIGNED16	RW	Y

ENGLISH

Index (Hex)	Sub	Object name	Description	Data type	R/W	S/R
1018	-	Identity Object		RECORD		
	0	Number of entries	Number of sub-indexes: 1	UNSIGNED8	R	
	1	Vender ID	0x000025E (Fuji Electric Group)	UNSIGNED32	R	
1029	-	Error behavior		RECORD		
	0	No. of Error Classes	Fixed at 1.	UNSIGNED8	R	
	1	Communication error	Transition destination selection at [communication error] 0:Pre-operational (only if current state is operational) 1:No state change 2:Stopped 3 to 127: Reserved	UNSIGNED8	RW	Y
1400	-	1st Receive PDO Communication Parameter		RECORD		
	0	Number of entries	Number of sub-indexes: 2	UNSIGNED8	R	
	1	COB-ID	COB-ID of RPDO 1 Default: 0x200 + Node-ID	UNSIGNED32	RW +1	Y
	2	Transmission type	Choice of transmission type Default: 255 (Change of state event) (See Tables 7.5 and 7.7.)	UNSIGNED8	RW	Y
1401	-	2nd Receive PDO Communication Parameter		RECORD		
	0	Number entries	Number of sub-indexes: 2	UNSIGNED8	R	
	1	COB-ID	COB-ID of RPDO 2 Default: 0x300 + Node-ID	UNSIGNED32	RW +1	Y
	2	Transmission type	Choice of transmission type Default: 255 (Change of state event) (See Tables 7.5 and 7.7.)	UNSIGNED8	RW	Y
1402	-	3rd Receive PDO Communication Parameter		RECORD		
	0	Number of entries	Number of sub-indexes: 2	UNSIGNED8	R	
	1	COB-ID	COB-ID of RPDO 3 Default: 0x400 + Node-ID	UNSIGNED32	RW +1	Y
	2	Transmission type	Choice of transmission type Default: 255 (Change of state event) (See Tables 7.5 and 7.7.)	UNSIGNED8	RW	Y
1600	-	1st Receive PDO Mapping Parameter		RECORD		
	0	Number of mapped objects	Number of mapped objects: 0 to 4	UNSIGNED8	RW +1	Y
	1 to 4	PDO mapping entry 1 to4	(See section 7.2 and 7.3)	UNSIGNED32	RW +1	Y
1601	-	2nd Receive PDO Mapping Parameter		RECORD		
	0	Number of mapped objects	Number of mapped objects: 0 to 4	UNSIGNED8	RW +1	Y
	1 to 4	PDO mapping entry 1 to 4	(See section 7.2 and 7.3)	UNSIGNED32	RW +1	Y
1602	-	3rd Receive PDO Mapping Parameter		RECORD		
	0	Number of mapped objects	Number of mapped objects: 4	UNSIGNED8	R	
	1 to 4	PDO mapping entry 1 to 4	Fixed object 0x5E02 sub 01 to 04	UNSIGNED32	R	

Index (Hex)	Sub	Object name	Description	Data type	R/W	S/R
1800	-	1st Transmit PDO Communication Parameter		RECORD		
	0	Largest sub-index	Max. sub-index number: 5	UNSIGNED8	R	
	1	COB-ID	COB-ID of TPDO 1 Default: 0x180 + Node-ID	UNSIGNED32	RW *1	Y
	2	Transmission type	Choice of transmission type Default: 255(Change of state event) (See Tables 7.5 and 7.7.)	UNSIGNED8	RW	Y
	3	Inhibit time (0.1ms)	Minimum interval for PDO transmission. Default: 100 (10.0 ms)	UNSIGNED16	RW *1	Y
	5	Event timer (ms)	Cyclic interval for PDO transmission in the transmission type 254 or 255. Default: 0 (Disable)	UNSIGNED16	RW	Y
1801	-	2nd Transmit PDO Communication Parameter		RECORD	-	
	0	Largest sub-index	Max. sub-index number: 5	UNSIGNED8	R	
	1	COB-ID	COB-ID of TPDO 2 Default: 0x280 + Node-ID	UNSIGNED32	RW *1	Y
	2	Transmission type	Choice of transmission type Default: 255(Change of state event) (See Tables 7.5 and 7.7.)	UNSIGNED8	RW	Y
	3	Inhibit time (0.1ms)	Minimum interval for PDO transmission. Default: 100 (10.0 ms)	UNSIGNED16	RW *1	Y
	5	Event timer(ms)	Cyclic interval for PDO transmission in the transmission type 254 or 255. Default: 0 (Disable)	UNSIGNED16	RW	Y
1802	-	3rd Transmit PDO Communication Parameter		RECORD	-	
	0	Largest sub-index	Max. sub-index number: 5	UNSIGNED8	R	
	1	COB-ID	COB-ID of TPDO 3 Default: 0x380 + Node-ID	UNSIGNED32	RW *1	Y
	2	Transmission type	Choice of transmission type Default: 255(Change of state event) (See Tables 7.5 and 7.7.)	UNSIGNED8	RW	Y
	3	Inhibit time (0.1ms)	Minimum interval for PDO transmission. Default: 100 (10.0 ms)	UNSIGNED16	RW *1	Y
	5	Event timer(ms)	Cyclic interval for PDO transmission in the transmission type 254 or 255. Default: 0 (Disable)	UNSIGNED16	RW	Y
1A00	-	1st Transmit PDO Mapping Parameter		RECORD		
	0	Number of mapped objects	Number of mapped objects: 0 to 4	UNSIGNED8	RW *1	Y
	1 to 4	PDO mapping entry 1 to 4	(See section 7.2 and 7.3)	UNSIGNED32	RW *1	Y
1A01	-	2nd Receive PDO Mapping Parameter		RECORD		
	0	Number of mapped objects	Number of mapped objects: 0 to 4	UNSIGNED8	RW *1	Y
	1 to 4	PDO mapping entry 1 to 4	(See section 7.2 and 7.3)	UNSIGNED32	RW *1	Y
1A02	-	3rd Receive PDO Mapping Parameter		RECORD		
	0	Number of mapped objects	Number of mapped objects: 0 to 4	UNSIGNED8	R	
	1 to 4	PDO mapping entry 1 to 4	(See section 7.2 and 7.3)	UNSIGNED32	R	

ENGLISH

*1 Only available to "W (write)" when the PDO is disable (bit 31 of the "COB-ID" is "1").

10.2 Objects in Fuji Specific Profile Area

Table 10.2 lists objects in the Fuji specific profile area. In the R/W column, "R" denotes Read-only and "RW" denotes Read/Write.

Table 10.2 Objects in Fuji Specific Profile Area

Index (Hex)	Sub	Object name	Description	Data type	R/W
2200	0	Bus state	Bus state of CAN communication 0: Normal 1: Bus-off or Error passive 2: Other errors	UNSIGNED8	R
3000	0	Node state	CANopen communication state 0: Not connected to CAN 1: Initialization in progress 2: Stopped 3: Pre-Operational 4: Operational	UNSIGNED8	R
5E00 -2	-	Assignment of RPDO 3		ARRAY	-
	0	Number of entries	Structures: 4	UNSIGNED8	R
	1	Function code 1	Function code assignment 1 for write in PDO 3 Default: the value specified by o40	UNSIGNED16	RW
	2	Function code 2	Function code assignment 2 for write in PDO 3 Default: the value specified by o41	UNSIGNED16	RW
	3	Function code 3	Function code assignment 3 for write in PDO 3 Default: the value specified by o42	UNSIGNED16	RW
	4	Function code 4	Function code assignment 4 for write in PDO 3 Default: the value specified by o43	UNSIGNED16	RW
5E01 -2	-	Assignment of TPDO 3		ARRAY	-
	0	Number of entries	Structures: 4	UNSIGNED8	R
	1	Function code 1	Function code assignment 1 for read in PDO 3 Default: the value specified by o48	UNSIGNED16	RW
	2	Function code 2	Function code assignment 2 for read in PDO 3 Default: the value specified by o49	UNSIGNED16	RW
	3	Function code 3	Function code assignment 3 for read in PDO 3 Default: the value specified by o50	UNSIGNED16	RW
	4	Function code 4	Function code assignment 4 for read in PDO 3 Default: the value specified by o51	UNSIGNED16	RW

ENGLISH

Index (Hex)	Sub	Object name	Description	Data type	R/W
5E02 *2	-	Assignment data of RPDO 3		ARRAY	-
	0	Number of entries	Structures: 4	UNSIGNED8	R
	1	Writing data 1	RPDO No.3 for writing data 1. Default: 0	UNSIGNED16	RW
	2	Writing data 2	RPDO No.3 for writing data 2. Default: 0	UNSIGNED16	RW
	3	Writing data 3	RPDO No.3 for writing data 3. Default: 0	UNSIGNED16	RW
	4	Writing data 4	RPDO No.3 for writing data 4. Default: 0	UNSIGNED16	RW
5E03 *2	-	Assignment data of TPDO 3		ARRAY	-
	0	Number of entries	Structures: 4	UNSIGNED8	R
	1	Reading data 1	TPDO No.3 for reading data 1. Default: 0	UNSIGNED16	R
	2	Reading data 2	TPDO No.3 for reading data 2. Default: 0	UNSIGNED16	R
	3	Reading data 3	TPDO No.3 for reading data 3. Default: 0	UNSIGNED16	R
	4	Reading data 4	TPDO No.3 for reading data 4. Default: 0	UNSIGNED16	R
5F02 to 5FFF *3	1 to 100	FRENIC's function code	Access to inverter's function code <u>Specifying the function code</u> Index= 5F□□, Sub= xx □□: Code type (See Table 7.3.) xx: Number + 1 Example: E01 → Index 5F05, Sub 02	UNSIGNED16	RW *1

*1 Writable only in the Operational state.

*2 For details about how to specify the function codes, refer to Chapter 7, Section 7.2 (4) "Configuring inverter's function codes o40 to o43, o48 to o51, and Indexes 5E00 and 5E01".



Modifying function code assignments using Index 5E00 or 5E01 immediately takes effect in the inverter. Note that restarting the inverter or issuing Reset Node to the inverter reverts them to the ones made by o40 to o43 and o48 to o51.

*3 For details about function code type, refer to Table 7.3. For details about the data format of function codes assigned, refer to the RS-485 Communication User's Manual, Chapter 5, Section 5.2 "Data Formats".

*4 Turning the inverter power OFF clears the current settings of inverter's function codes S01, S05, S06, S07, S12, S13, and S19.

10.3 Standard Device Profile Area

Table 10.3 lists objects in the standard device profile area.

R/W: Object access type. "R": denotes Read-only "RW": Read/Write

Map: It shows the mapping attribute of PDO.

"R": Can be mapped to RPDO "T": Can be mapped to TPDO

S/R: "Y" Indicates the object which is affected by object 1010/1011 (Store/Restore).

Table 10.3 Objects in Standard Device Profile Area

Index (Hex)	Sub	Object name	Description	Data type	R/W	Map	S/R
603F	-	Error code	Alarm history (latest alarm info) (For details, refer to Table 14.1.)	UNSIGNED16	R	T	
6040	-	Controlword	Drive control (Controlling the DS 402 state machine)	UNSIGNED16	RW	R	
6041	-	Statusword	Status monitor (Displaying the status of the DS 402 state machine)	UNSIGNED16	R	T	
6042	-	vl target velocity	Speed command (r/min)	INTEGER16	RW	R	Y
6043	-	vl velocity demand	Speed monitor (r/min) *3 (Equivalent to inverter's function code Z79)	INTEGER16	R	T	
6044	-	vl control effort	Speed monitor (r/min) (Equivalent to inverter's function code M79)	INTEGER16	R	T	
6046	-	vl velocity min max amount		ARRAY			
	0	Number of entries	Number of sub-indexes: 2	UNSIGNED8	R		
	1	vl velocity min amount	Minimum output speed (r/min) (Equivalent to inverter's function code F16)	UNSIGNED32	RW	R	Y
	2	vl velocity max amount	Maximum speed (r/min) (Equivalent to inverter's function codes F03/A01/b01/r01 *1)	UNSIGNED32	RW	R	Y
6048	-	vl velocity acceleration *2 (Specifying acceleration using the Delta speed and Delta time. Equivalent to inverter's function code S08)		RECORD			
	0	Number of entries	Number of sub-indexes: 2	UNSIGNED8	R		
	1	Delta speed	Delta speed (r/min) in acceleration during the Delta time	UNSIGNED32	RW	R	Y
	2	Delta time	Delta time (s)	UNSIGNED16	RW	R	Y
6049	-	vl velocity deceleration *2 (Specifying deceleration using the Delta speed and Delta time. Equivalent to inverter's function code S09)		RECORD			
	0	Number of entries	Number of sub-indexes: 2	UNSIGNED8	R		
	1	Delta speed	Delta speed (r/min) in deceleration during the Delta time	UNSIGNED32	RW	R	Y
	2	Delta time	Delta time (s)	UNSIGNED16	RW	R	Y
604A	-	vl velocity quick stop *2 (Specifying deceleration time for quick stop using the Delta speed and Delta time. Equivalent to inverter's function code H56)		RECORD			
	0	Number of entries	Number of sub-indexes: 2	UNSIGNED8	R		
	1	Delta speed	Delta speed (r/min) in deceleration during the Delta time	UNSIGNED32	RW	R	Y
	2	Delta time	Delta time (s)	UNSIGNED16	RW	R	Y

ENGLISH

Index (Hex)	Sub	Object name	Description	Data type	R/W	Map	S/R
604B	-	vl set-point factor *4 Changes the resolution and range for the speed setting		ARRAY			
	0	Highest sub-index supported	Number of sub-indexes: 2	UNSIGNED8	R		
	1	Numerator	-32768 to +32767 *Except for 0; treated as "1" when the setting is made.	INTEGER16	RW	R	Y
	2	Denominator	(Equivalent to Inverter's function codes Sub 1: C89, Sub 2: C90)	INTEGER16	RW	R	Y
604D	-	vl pole number	Number of poles in motor (Equivalent to inverter's function codes P01/A15/b15/r15 *1)	UNSIGNED8	RW	R	Y
6060	-	Modes of operation	Choice of mode for DS 402 state machine.	INTEGER8	W	R	
6061	-	Modes of operation display	Confirmation of mode selected for DS 402 state machine Fixed at 2 (= Velocity mode)	INTEGER8	R	T	
6077	-	Torque actual value	1000=100.0% Actual value of instantaneous torque (Equivalent to Inverter's function code M07 [10000=100.00%]) *5	UNSIGNED16	R	T	
6078	-	Current actual value	1000=100.0% Actual value of output current (Equivalent to Inverter's function code M11 [10000=100.00%]) *5	UNSIGNED16	R	T	

*1 Depending upon the motor selected, the equivalent function codes automatically switch.

 For details about motor selection, refer to the inverter Instruction Manual, "A codes, b codes and r codes."

*2 Regarding "6048" "6049" "604A" objects, please note as follows:

* "Delta speed" is re-calculated from "Acceleration / Deceleration rate" (from F03, F07/F08 and P01) and "Delta time" at power-on.

* "Acceleration / Deceleration rate" (F07/F08) always keep user configured value.

* "Delta time" (Sub-index 2) uses its stored value if the objects "6048", "6049" or "604A" has been stored by object "1010".

* If the objects "6048", "6049" or "604A" have not been stored, each "Delta time" is set to 10 s (default value).

* Both "Delta speed" and "Delta time" have to be reconfigured by the user in the following cases:

Case 1) Applied motor is switched (for example, from motor 1 to motor 2).

Case 2) Number of poles has been changed.

Case 3) Maximum output frequency has been changed.

*3 In an inverter model which does not support Z79, object 6043 is same as object 6044.

*4 In an inverter model which does not support C89 and C90, 604B will reflect the percentage only of the value of "6042 to 6044".

*5 The minimum resolution of CANopen object is different from inverter function code.

Chapter 11 DRIVING THE INVERTER VIA CANopen NETWORK

There are the following two ways to drive the inverter via CANopen network.

- (1) Driving with CANopen Drive Profile (DSP 402)
- (2) Driving with Inverter's Function Code S06

11.1 Driving with CANopen Drive Profile (DSP 402)

(1) List of related objects

Index (Hex.)	Sub	Object name	Description	Data type	Access
6040	-	Controlword	Controls the state transition of the state machine	UNSIGNED16	RW
6041	-	Statusword	Monitors the current status	UNSIGNED16	R
6042	-	vl target velocity	Speed command (r/min)	INTEGER16	RW
6044	-	vl control effort	Speed monitor (r/min)	INTEGER16	R

Tip To control the inverter, it is convenient to use PDO 2 that is capable of sending Controlword and speed command (vl target velocity) at the same time (in case that mapped objects to the PDOs are factory defaults).

(2) Details of related objects

■ Controlword

bit 7	bit 6	bit 5	bit 4	bit 3	bit 2	bit 1	bit 0
Fault reset	0	0	0	Enable operation	Quick stop	Enable voltage	Switch on
bit 15	bit 14	bit 13	bit 12	bit 11	bit 10	bit 9	bit 8
X4	X3	X2	X1	Reverse	0	0	Halt

- bits 0 to 3 : Control the state machine for state transition. See Figure 11.1.
- bit 7 Fault reset : Change from 0 to 1 to reset an alarm.
- bit 8 Halt : 1 = Fix the inverter's output speed at 0 r/min
- bit 11 Reverse : Specify the rotational direction. 0 = Forward, 1 = Reverse.
- bits 12 to 15 : Turn digital input terminals [X1] to [X4] OFF or ON. 0 = OFF, 1 = ON

■ Statusword

bit 7	bit 6	bit 5	bit 4	bit 3	bit 2	bit 1	bit 0
Warning	Switch on disabled	Quick stop	Voltage enabled	Fault	Operation enabled	Switched On	Ready to switch on
bit 15	bit 14	bit 13	bit 12	bit 11	bit 10	bit 9	bit 8
Direction of rotation	0	0	0	Internal limit active	Target reached	Remote	0

- bits 0 to 2, 5, 6 : Status display of the state machine. See Figure 11.1.
- bit 3 Fault : 1 = Tripped
- bit 4 Voltage enabled : 1 = Voltage applied to the main circuit
- bit 7 Warning : Not used. Fixed at 0.
- bit 9 Remote : 1 = Either one of speed and run commands via CANopen is valid.
- bit 10 Target reached : 1 = Reference speed reached
- bit 11 Internal limit active : 1 = Torque, voltage, or current limiter activated
- bit 15 Direction of rotation : 0 = Forward or stop, 1 = Reverse

■ vI target velocity

This specifies the speed command (r/min). Data setting range: -32768 to 32767 r/min

■ vI control effort

This monitors the current output speed to display (r/min). Output range: -32768 to 32767 r/min

(3) State machine

Operating the state machine (the state transition flow in Figure 11.1) stipulated in the DSP 402 drives the inverter. Controlword (CTW in the figure) causes the state transition of the state machine, and Statusword (STW in the figure) monitors the state.

Table 11.1 lists the commands to the inverter at each of the state transition times.



Transition to State 5 "Operation enabled" (see Figure 11.1) sets the inverter in run state.

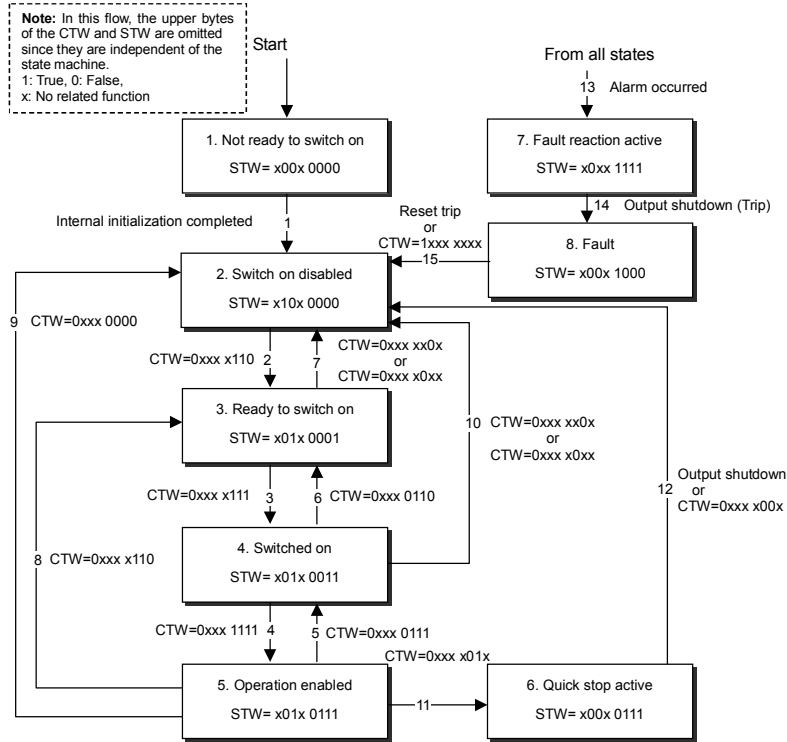

Figure 11.1 State Machine

Table 11.1 Relationship between State Machine and Inverter Status

State No.	Name	Inverter status
1	Not ready to switch on	Initialization of the CANopen communications card in progress
2	Switch on disabled	Inverter alarm released
3	Ready to switch on	Inverter output shut down
4	Switched on	Inverter stopped (Run command OFF)
5	Operation enabled	Inverter running (Run command ON)
6	Quick stop active	Inverter quick stopped (within the time specified by Index 604A)
7	Fault reaction active	Alarm detected
8	Fault	Inverter tripped

ENGLISH

(4) Communication example

This section gives an actual communication example that controls the DSP 402 state machine in order to drive the inverter. This example uses PDO 2 under the following conditions:

- Node-ID of the inverter (communications card): 1 (Inverter's function code o31 = 1)
- Transmit PDOs 1 and 3: Disabled
That is, Index 1800 Sub 1 = 0x80000181 and Index 1802 Sub 1 = 0x80000381
- All other CANopen objects: Default setting
- Inverter's function code y98 = 3

The format of PDO 2 is shown below.

■ Receive PDO (Master → Inverter)

COB-ID	Byte 0	Byte 1	Byte 2	Byte 3
0x301	Controlword (L byte) (H byte)		vl_target_velocity (L byte) (H byte)	

■ Transmit PDO (Inverter → Master)

COB-ID	Byte 0	Byte 1	Byte 2	Byte 3
0x281	Statusword (L byte) (H byte)		vl_control_effort (L byte) (H byte)	

- 1) Upon receipt of Start_Remote_Node service from the master, the inverter shifts to the Operational state (the green RUN LED on the communications card turns ON) in which it is ready for PDO communication. At the same time, the inverter responds to the master with the following transmit PDO 2. The lower byte of Statusword (Bytes 0 and 1) is 50, indicating that the state machine is in state 2.

Transmit PDO (Inverter → Master)	COB-ID	Byte 0	Byte 1	Byte 2	Byte 3
	0x281	50	02	00	00

- 2) To shift the state machine from state 2 to state 3, send the following data in Controlword (Bytes 0 and 1) from the master.

Receive PDO (Master → Inverter)	COB-ID	Byte 0	Byte 1	Byte 2	Byte 3
	0x301	06	00	00	00

Upon receipt of the above, the inverter responds to the master with the following transmit PDO. The lower byte of Statusword (Bytes 0 and 1) is 31, indicating that the state machine is in state 3.

Transmit PDO (Inverter → Master)	COB-ID	Byte 0	Byte 1	Byte 2	Byte 3
	0x281	31	02	00	00

- 3) To shift the state machine from state 3 to state 4, send the following data in Controlword (Bytes 0 and 1) from the master.

Receive PDO	COB-ID	Byte 0	Byte 1	Byte 2	Byte 3
(Master → Inverter)	0x301	07	00	00	00

Upon receipt of the above, the inverter responds to the master with the following transmit PDO. The lower byte of Statusword (Bytes 0 and 1) is 33, indicating that the state machine is in state 4.

Transmit PDO	COB-ID	Byte 0	Byte 1	Byte 2	Byte 3
(Inverter → Master)	0x281	33	02	00	00

- 4) To shift the state machine from state 4 to state 5 (Run forward command) and issue a speed command, send the following data in Controlword from the master. In this example, enter the speed command 1800 r/min (= 0x0708) to `vl_target_velocity` (Bytes 2 and 3).

Receive PDO	COB-ID	Byte 0	Byte 1	Byte 2	Byte 3
(Master → Inverter)	0x301	0F	00	08	07

Upon receipt of the above, the inverter starts running, accelerating to a speed of 1800 r/min. The lower byte of Statusword (Bytes 0 and 1) is 37, indicating that the state machine is in state 5. During acceleration, the output speed monitor `vl_control_effort` (Bytes 2 and 3) changes its value, so the inverter sends the following data continually until the inverter reaches the target speed.

Transmit PDO	COB-ID	Byte 0	Byte 1	Byte 2	Byte 3
(Inverter → Master)	0x281	37	02	**	**

- 5) To stop the inverter, shift the state machine from state 5 to state 4.

Receive PDO	COB-ID	Byte 0	Byte 1	Byte 2	Byte 3
(Master → Inverter)	0x301	07	00	08	07

Upon receipt of the above, the inverter starts decelerating. The lower byte of Statusword (Bytes 0 and 1) is 33, indicating that the state machine is state 4. During deceleration also, the output speed monitor `vl_control_effort` (Bytes 2 and 3) changes its value, so the inverter sends the following data continually until the inverter comes to a stop.

Transmit PDO	COB-ID	Byte 0	Byte 1	Byte 2	Byte 3
(Inverter → Master)	0x281	33	02	**	**

11.2 Driving with Inverter's Function Code S06

Note Important

To enable run commands specified by S06, all of the following conditions should be satisfied:

- Receive PDOs 1 and 2: Disabled
That is, Index 1400 Sub 1 = 0x80000xxx and Index 1401 Sub 1 = 0x80000xxx
- DSP 402 state machine: State 2
- Inverter's function code y98 = 2 or 3

(1) List of related objects

Index (Hex.)	Sub (Hex)	Object name	Description	Data type	Access
5F02	07	Inverter's function code S06	Run command (Note)	UNSIGNED16	RW
5F03	0F	Inverter's function code M14	Monitors the running status	UNSIGNED16	R
5F02	06	Inverter's function code S05	Frequency command (in units of 0.01 Hz)	INTEGER16	RW
5F02	14	Inverter's function code S19	Frequency command (in units of rpm)	INTEGER16	RW
5F03	0A	Inverter's function code M09	Monitors the output frequency (in units of 0.01 Hz)	INTEGER16	R
5F03	50	Inverter's function code M79	Monitors the output frequency (in units of rpm)	INTEGER16	R

Note Inverters driven by S06 do not follow the DSP 402 state machine, so the Statusword does not show the inverter status. Use inverter's function code M14, instead.

Tip To drive inverters with S06, using PDO3 is convenient. For details about PDO 3, refer to Chapter 7 "PDO PROTOCOL."

(2) Details of related objects

■ Inverter's communication-dedicated function code S06

bit 7	bit 6	bit 5	bit 4	bit 3	bit 2	bit 1	bit 0
X6	X5	X4	X3	X2	X1	REV	FWD

bit 15	bit 14	bit 13	bit 12	bit 11	bit 10	bit 9	bit 8
RST	XR	XF	0	0	X9	X8	X7

- bit 0 FWD : 1 = Run forward command
- bit 1 REV : 1 = Run reverse command
- bits 2 to 10, X1 to X9 : Communication control input terminals*
- bits 13,14 XF, XR : Communication control input terminals (Digital input terminals [XF] (FWD) and [XR] (REV))
- bit 15 RST : Change from 0 to 1 to clear the tripped state.

*The number of terminals depends on the inverter type.

■ Inverter's communication-dedicated function code M14

bit 7	bit 6	bit 5	bit 4	bit 3	bit 2	bit 1	bit 0
VL	TL	NUV	BRK	INT	EXT	REV	FWD
bit 15	bit 14	bit 13	bit 12	bit 11	bit 10	bit 9	bit 8
BUSY	0	0	RL	ALM	DEC	ACC	IL

- bit 0 FWD : 1 = Running forward
- bit 1 REV : 1 = Running reverse
- bit 2 EXT : 1 = During DC braking or pre-exciting
- bit 3 INT : 1 = Inverter shutdown
- bit 4 BRK : 1 = Braking
- bit 5 NUV : 1 = DC link bus voltage established
- bit 6 TL : 1 = Torque limiting
- bit 7 VL : 1 = Output voltage limiting
- bit 8 IL : 1 = Output current limiting
- bit 9 ACC : 1 = During acceleration
- bit 10 DEC : 1 = During deceleration
- bit 11 ALM : 1 = Alarm relay output
- bit 12 RL : 1 = Communication active
- bit 15 BUSY : 1 = Busy in writing function codes

■ Inverter's communication-dedicated function code S05

This specifies the frequency command in units of 0.01 Hz. Data setting range: -327.68 to 327.67 Hz

■ Inverter's communication-dedicated function code M09

This shows the current output frequency in units of 0.01 Hz. Data output range: -327.68 to 327.67 Hz

■ Inverter's communication-dedicated function code M79

This shows the current output frequency in units of rpm. Data output range: -32768 to 32767 rpm

(3) Communication example

This section gives an actual communication example that uses S06 in order to drive the inverter. This example uses PDO 3 under the following conditions:

- Node-ID of the inverter (communications card): 1 (Inverter's function code o31 = 1)
- Assignment of PDO 3:
 - o40 = 0206 (Function code 1 for write = S06) o48 = 030E (Function code 1 for read = M14)
 - o41 = 0205 (Function code 2 for write = S05) o49 = 0309 (Function code 2 for read = M09)
 - o42 = 0000 (Function code 3 for write = None) o50 = 0000 (Function code 3 for read = None)
 - o43 = 0000 (Function code 4 for write = None) o51 = 0000 (Function code 4 for read = None)
- Receive PDOs 1 and 2: Disabled
That is, Index 1400 Sub 1 = 0x80000201 and Index 1401 Sub 1 = 0x80000301
- Transmit PDOs 1 and 2: Disabled
That is, Index 1800 Sub 1 = 0x80000181 and Index 1801 Sub 1 = x80000281
- All other CANopen objects: Default setting
- Inverter's function code y98 = 3

The format of PDO 3 assigned as above is shown below.

■ Receive PDO (Master → Inverter)

COB-ID	Byte 0	Byte 1	Byte 2	Byte 3	Byte 4	Byte 5	Byte 6	Byte 7
0x401	S06 (L byte) (H B byte)		S05 (L byte) (H byte)		No assignment		No assignment	

■ Transmit PDO (Inverter → Master)

COB-ID	Byte 0	Byte 1	Byte 2	Byte 3	Byte 4	Byte 5	Byte 6	Byte 7
0x381	M14 (L byte) (H byte)		M09 (L byte) (H byte)		No assignment		No assignment	

- 1) Upon receipt of Start_Remote_Node service from the master, the inverter shifts to the Operational state (green RUN LED ON) in which it is ready for PDO communication. At the same time, the inverter responds to the master with the following transmit PDO 3.

Transmit PDO (Inverter → Master)	COB-ID	Byte 0	Byte 1	Byte 2	Byte 3	Bytes 4 to 7
	0x381	28	10	00	00	00000000

- 2) To send the run command "S06 = 1 (FWD = 1)" and the frequency command "S05 = 50.00 Hz (=0x1388)", enter the data as shown below.

Receive PDO (Master → Inverter)	COB-ID	Byte 0	Byte 1	Byte 2	Byte 3	Bytes 4 to 7
	0x401	01	00	88	13	00000000

Upon receipt of the above, the inverter starts running. When it reaches the reference speed, it sends the following transmit PDO.

Transmit PDO (Inverter → Master)	COB-ID	Byte 0	Byte 1	Byte 2	Byte 3	Bytes 4 to 7
	0x381	21	10	88	13	00000000

- 3) To stop the inverter, send "S06 = 0 (FWD = 0)" from the master.

Receive PDO (Master → Inverter)	COB-ID	Byte 0	Byte 1	Byte 2	Byte 3	Bytes 4 to 7
	0x401	00	00	88	13	00000000

Upon receipt of the above, the inverter starts decelerating. When it comes to a stop, it sends the following transmit PDO.

Transmit PDO (Inverter → Master)	COB-ID	Byte 0	Byte 1	Byte 2	Byte 3	Bytes 4 to 7
	0x381	28	10	00	00	00000000

ENGLISH

- 4) To run the inverter in the reverse direction, send "S06 = 2 (REV = 1)" from the master.

Receive PDO (Master → Inverter)	COB-ID	Byte 0	Byte 1	Byte 2	Byte 3	Bytes 4 to 7
	0x401	02	00	88	13	00000000

Upon receipt of the above, the inverter starts running in the reverse direction. When it reaches the reference speed, it sends the following transmit PDO.

Transmit PDO (Inverter → Master)	COB-ID	Byte 0	Byte 1	Byte 2	Byte 3	Bytes 4 to 7
	0x381	22	10	88	13	00000000

Chapter 12 HEARTBEAT AND NODE-GUARDING

The Heartbeat and Node Guarding services are provided for detecting disconnection. We recommend you to use either one.

Note Important: The use of either Heartbeat or Node Guarding is recommended
The setting for detecting disconnection in the CANopen device is invalid by default. Unless the setting is enabled, the CANopen network including inverter can not detect a disconnection even if the disconnection occurs. We strongly recommend to enable the setting.

12.1 Heartbeat

Heartbeat is a mechanism to detect the disconnection in the CANopen network by monitoring the signals from the specified node.

 For details about Heartbeat, refer to the CANopen Specifications DS 301.

Note Do not use both Heartbeat and Node Guarding at the same time. If they are used at the same time, the disconnection is not detected properly. To use Heartbeat, make Node Guarding invalid, that is, set Index 100C=0 and Index 100D=0 (refer to Section 12.2).

(1) List of related objects

Index (Hex.)	Sub	Object name	Description	Data type	Access
1016	-	Consumer heartbeat time		ARRAY	
	0	Number of entries	Number of configurations: 1	UNSIGNED8	R
	1	Consumer heartbeat time	Upper word: Node ID to be monitored Lower word: Heartbeat monitoring time Default: 0 (Disable)	UNSIGNED32	RW
1017	-	Producer heartbeat time	Heartbeat message transmitting cycle Default: 0 (Disabled)	UNSIGNED16	RW

(2) Consumer heartbeat time

It is the preset time interval within the Heartbeat signals should be received from the specified node ID (Heartbeat producer). The behavior is as follows: if the Heartbeat signal cannot be received over monitoring time, the disconnection is deemed to occur.

The format is shown below. If the heartbeat consumer fails to receive a heartbeat signal within the specified monitoring time, it will be judged as an occurrence of a CANopen network break.

 For inverter reactions to apply when a CANopen network break occurs, refer to Chapter 13 "INVERTER REACTIONS TO CANopen NETWORK BREAKS."

Byte 0	Byte 1	Byte 2	Byte 3	Byte 4	Byte 5	Byte 6	Byte 7
0000		Node-ID to be monitored		Heartbeat monitoring time (ms)			

(3) Producer heartbeat time

The heartbeat producer automatically keeps transmitting a heartbeat signal in the specified cycle (in units of 1 ms). Any other node(s) (heartbeat consumer) monitors the heartbeat signal.

12.2 Node Guarding

Node Guarding is a mechanism to detect disconnections by monitoring the guarding signals periodically sent from the master.

 For details about Node Guarding, refer to the CANopen Specifications DS 301.

 **Note** Do not use both Heartbeat and Node Guarding at the same time. If they are used at the same time, the disconnection is not detected properly. To use Node Guarding, make Heartbeat invalid, that is, set Index 1016=0 and Index 1017=0 (refer to Section 12.1).

(1) List of related objects

Index (Hex.)	Sub	Object name	Description	Data type	Access
100C	-	Guard time	Guarding reception cycle setting (ms) Default: 0 (Disable)	UNSIGNED16	RW
100D	-	Life time factor	Guarding time coefficient Default: 0 (Disable)	UNSIGNED8	RW

(2) Guard time and life time factor

Sets the receive interval of Guarding signals from the master. If the Guarding signal can not be received over preset receiving time, the disconnection is deemed to occur.

Set the receive interval in the equation below:

$$\text{Guarding receiving interval (ms)} = \text{Guard time (ms)} \times \text{Life time factor}$$

Example: If the guard time is 100 ms and the life time factor is 5,

$$\text{Guarding receiving interval} = 100 \text{ ms} \times 5 = 500 \text{ ms}$$

 For inverter reactions to apply when a CANopen network break occurs, refer to Chapter 13 "INVERTER REACTIONS TO CANopen NETWORK BREAKS".

Chapter 13 INVERTER REACTIONS TO CANopen NETWORK BREAKS

CAN communications error might not occur depending on the combination of setting values.

Inverter's function codes o27 and o28 define inverter reactions to apply if the inverter detects a CANopen network break, as described in Table 13.1 and Table 13.2.

(1) Related object and function code list

No	CANopen object Index (Hex)	Function code	Description
1	6007 Sub 0	-	Communication abort option code. Setting the behavior when a communication error occurs.
2	1029 Sub 1	-	Error behavior Setting the NMT state transition destination when a communication error occurs.
3	-	o27,o28	Error reaction (inverter side). Setting the behavior when a communication error occurs.
4	-	H81	Assigned minor failure (inverter side). Setting if it is treated as a minor failure when error occurs.

In any of the following cases, the communications card judges it as an occurrence of a network break.

Case1: Network break detected by Consumer Heartbeat or Node Guarding

Case2: Occurrence of bus-off in CAN

Case3: NMT state change (Operational -> Other state)

Table 13.1 Network break detection by object 6007 set value

6007(Hex)	Case1	Case2	Case3	Description
0(0000)				[no action] Ignoring the communications error.
1(0001)	Detect	Detect		[malfunction]
-1(FFFF)	Detect	Detect	Detect	Immediately coast to a stop and trip with E_r-5 . (*)
2(0002)	Detect	Detect		[Device control command 'Disable Voltage']
-2(FFFE)	Detect	Detect	Detect	CTW=Disable voltage [no E_r-5 . trip]
3(0003)	Detect	Detect		[Device control command 'Quick Stop']
-3(FFFD)	Detect	Detect	Detect	CTW= Quick stop [no E_r-5 . trip]
-4(FFFC)	Detect	Detect		[malfunction manufacturer specific] (*)
-5(FFFB)	Detect	Detect	Detect	(Refer to Table13.3)

Note * If set to "Er5 (disconnection abnormality)" to handle as a minor failure by setting inverter's function code [H81], motor does not trip, and error does not occur.

 For details about Consumer Heartbeat or Node Guarding, refer to Chapter 12 "Heartbeat and Node Guarding".

 If a communications error occurs, the LED status indicators on the communications card indicate the error state. For details, refer to Chapter 2, Section 2.3 "LED Status Indicators".

Table 13.2 Changes the NMT state by 1029 setting at the time of error occurrence

1029 Sub1 (Hex)	NMT state of change destination	Remarks
0	Pre-operational	(only if currently in NMT state Operational)
1	(no change)	No change of the NMT state
2	Stopped	The State Machine (refer to Figure 11.1) and CTW are initialized.

Note If 6007=-4/-5 and 1029 setting is other than "1", the speed command and control command become ineffective before error processing.



About Item "H81 assign" in the below table 13.3.
It shows the behavior in the case that "Er5 (disconnection abnormality)" is set to be handled as a minor failure by setting inverter's function code [H81].

Table13.3 Inverter Reactions to CANopen Network Breaks

o27	o28	Inverter Reactions to CANopen Network Breaks	H81 assign
0, 4 to 9	Invalid	Immediately coast to a stop and trip with E_{r5} .	Immediately L_{rFL} (no trip)
1	0.0 to 60.0 s	After the time specified by o28, coast to a stop and trip with E_{r5} .	After the time specified by o28. L_{rFL} (no trip)
2	0.0 to 60.0 s	If the inverter receives any data within the time specified by o28, ignore the communications error. After the timeout, coast to a stop and trip with E_{r5} .	Same as above
3, 13 to 15	Invalid	Keep the current operation, ignoring the communications error (no E_{r5} trip).	No stop, no trip and no L_{rFL}
10	Invalid	Immediately decelerate to a stop. (*) Issue E_{r5} after stopping.	Immediately L_{rFL} (no stop)
11	0.0 to 60.0 s	After the time specified by o28, decelerate to a stop. Issue E_{r5} after stopping. (*)	After the time specified by o28. L_{rFL} (no stop)
12	0.0 to 60.0 s	If the inverter receives any data within the time specified by o28, ignore the communications error. After the timeout, decelerate to a stop and trip with E_{r5} . (*)	Same as above

* Specify the deceleration time by the inverter function code F08.

(2) Restart from CANopen network disconnection failure

The ordinary restart sequence after recovering CANopen communication failure is shown the following figure. Another sequence with [Reset node] command from master controller can also restart from the failure.

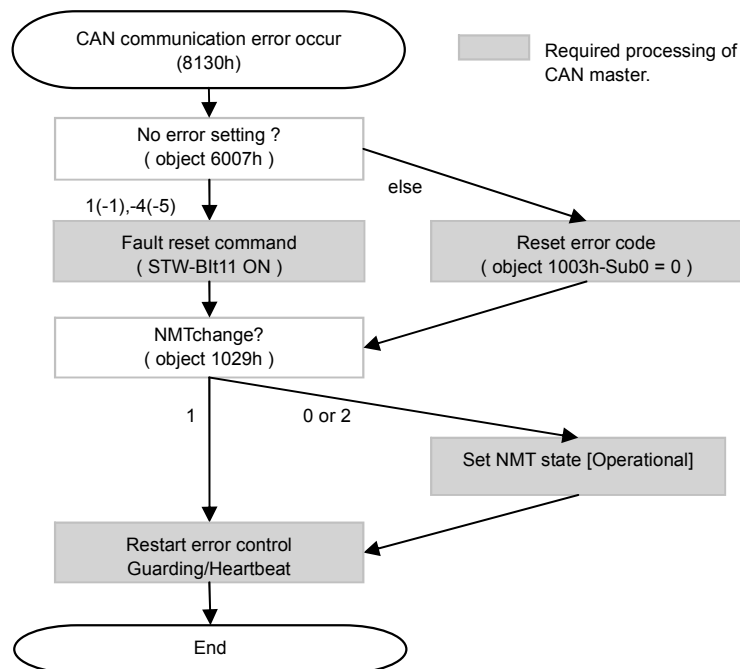

ENGLISH

Chapter 14 LIST OF INVERTER ALARM CODES

There are the following two ways to read out alarm codes generated when the inverter itself trips, via the CANopen network.

- (1) Read out alarm codes stipulated in CANopen from Index 1003 Sub 1 Standard error field or Index 603F Error code.

Tip: If an alarm occurs, CANopen service automatically sends an EMCY message to the CANopen master (see Chapter 9) and writes the alarm code into Index 1003 Sub 1 Standard error field and Index 603F Error code. Note that the EMCY message cannot be retained so that it cannot be read out later.

- (2) Read out alarm codes using inverter's function codes M16, M17, M18, and M19 (latest, last, 2nd last, and 3rd last alarm codes).

Table 14.1 lists alarm codes available.

Table 14.1 Alarm Codes

Error field(Hex)	Descriptions		Fuji's Alarm code (M16 to M19)
0000	No alarm	-	0
1000	Motor selection error	<i>ErL</i>	43
	Rescue by brake alarm	<i>rbrA</i>	71
	Reaching maximum numbers of trip counter	<i>tcrA</i>	72
	Load-cell overload	<i>lco</i>	74
2310	Instantaneous overcurrent (during acceleration)	<i>oC1</i>	1
	Instantaneous overcurrent (during deceleration)	<i>oC2</i>	2
	Instantaneous overcurrent (during constant speed)	<i>oC3</i>	3
2330	Earth fault	<i>EF</i>	5
3130	Input phase loss	<i>Lin</i>	11
3140	Input Frequency fault	<i>FrE</i>	12
3210	Overvoltage (during acceleration)	<i>oU1</i>	6
	Overvoltage (during deceleration)	<i>oU2</i>	7
	Overvoltage (during constant speed)	<i>oU3</i>	8
3220	Undervoltage	<i>LU</i>	10
3221	Data saving error during undervoltage	<i>ErF</i>	51
3300	Output phase loss	<i>oPL</i>	46
4110	Inverter overload	<i>oLU</i>	25
4210	Heat sink overheat	<i>oH1</i>	17
	Inverter internal overheat	<i>oH3</i>	19
	Charging resistor overheat	<i>oH6</i>	70
	Over heat of DB resistor	<i>oBH</i>	22
4310	Motor protection (PTC/NTC thermistor)	<i>oH4</i>	20
	Overload of Motor1	<i>oL1</i>	23
	Overload of Motor2	<i>oL2</i>	24
	Overload of Motor3	<i>oL3</i>	44
	Overload of Motor4	<i>oL4</i>	45
5110	Low battery	<i>Lob</i>	250
5210	AD converter defective	<i>Er9</i>	39
5220	CPU error	<i>Er3</i>	33
	Hardware error	<i>ErH</i>	54
5400	DB transistor failure	<i>dbR</i>	59

Error field(Hex)	Descriptions		Fuji's Alarm code (M16 to M19)
5430	Enable circuit error	<i>ECF</i>	57
5440	Charger circuit fault	<i>PBF</i>	16
	Short-circuit control error	<i>SCR</i>	73
5450	Fuse blown	<i>FUS</i>	14
	DC Fuse blown	<i>dCF</i>	15
5453	AC Fuse break	<i>ACF</i>	13
5500	Memory error	<i>Er-1</i>	31
	Time information loss	<i>dTL</i>	251
6320	Customizable logic error	<i>ECL</i>	65
	Password protection	<i>LoP</i>	253
7110	Brake confirmation	<i>bbE</i>	60
7120	Magnetic pole sensor error	<i>Er-E</i>	50
	Out-of-step detection	<i>Er-d</i>	42
7200	Tuning error	<i>Er-7</i>	37
	Current input disconnect detection	<i>LoF</i>	58
7300	Wiring break in a NTC thermistor	<i>nrb</i>	29
	PID1 feedback wire break detection	<i>PU1</i>	66
	PID2 feedback wire break detection	<i>PU2</i>	67
	External PID1 feedback wire break detection	<i>PUA</i>	91
	External PID2 feedback wire break detection	<i>PUb</i>	92
	External PID3 feedback wire break detection	<i>PUc</i>	93
7301	Wiring break in a PG	<i>PG</i>	28
7310	Over speed error	<i>oS</i>	27
7500	USB communications error	<i>Er-u</i>	68
7510	Option communications error	<i>Er-4</i>	34
	RS-485 communications error	(COM port1) <i>Er-B</i>	38
		(COM port2) <i>Er-P</i>	53
7520	Keypad communications error	<i>Er-2</i>	32
8100	CANopen error	<i>Er-5</i>	35
8400	Speed mismatching (Out of speed control)	<i>Er-E</i>	47
8500	Position control error	<i>Er-o</i>	56
8600	Position deviation error	<i>dD</i>	52
8A00	Drought protection	<i>Pdr</i>	81
	Control of maximum starts per hour	<i>roE</i>	82
	End of curve protection	<i>Pol</i>	83
	Anti jam	<i>rLo</i>	84
	Filter clogging error	<i>FoL</i>	85
9000	External alarm	<i>oM2</i>	18
	Forced operation	<i>Fod</i>	252
F004	Operation protection	<i>Er-B</i>	36
FF00	Mock alarm	<i>Err</i>	254

ENGLISH

 Each inverter model has its own alarm codes. Not all alarm codes are supported with each inverter model. Please refer to the instruction manual of each series for more information.

The Error codes corresponding to CANOpen communication are shown below

Error field (Hex)	Descriptions		Fuji's Alarm code (M16 to M19)
8110	CAN overrun	-	-
8120	Error passive mode of CAN-bus-state	-	-
8130	Life guard error or Heartbeat error	-	-
8140	Recovered from bus-off (CAN-bus-state)	-	-
8150	Transmit COB-ID collision	-	-
8200	Protocol error	-	-
8210	PDO not processed due to data length error	-	-
8220	PDO length exceeded	-	-

Chapter 15 NOTES ON USE OF COMMUNICATIONS CARD

This chapter provides notes on the use of the communications card.

- (1) Avoid using the communications card with Transmission type = 255 (Transmit every time data changes) in both transmit PDOs (TPDOs) 2 and 3 and Inhibit time = 0 at the same time. Such settings result in a lot of CANopen network traffic depending upon the frequency of data changes, degrading the intrinsic performance of the communications card. Decrease the transmission frequency in either one of TPDOs 2 and 3 by increasing the Inhibit time or using Sync signals.
- (2) The minimum timer resolution is 1ms. So the setting value lower than 1ms is rounded up according to this minimum resolution.
e.g. 11.1ms of setting value is treated as 12ms.
- (3) To stop auto tuning triggered via CANopen network (Writing to inverter's function code P04, A18, b18 or r18), write "0" to the corresponding function code.
- (4) If the same object is mapped in the same RPDO, the information mapped later will be valid.
Example: If CTW is mapped in all mapping entries of RPDO1, only the last data is valid.

	CTW(6040)	CTW(6040)	CTW(6040)	CTW(6040)
RPDO No.1	Invalid	Invalid	Invalid	Valid

- (5) Relationship between 6043 and 6044 in TPDO
 - The simultaneity of numeric value is not guaranteed in order to poll internal data of inverter
 - In an inverter model which does not support Z79, object 6043 is same as object 6044.
- (6) How to initialize the data which is stored in the communication card
The following procedure is required by the keypad.
 1. Set both function code value of the [o33, o34] to '0'.
 2. Function code [o33], set to '254'.
 3. Function code [o34], set to '100'.
 4. Please make sure that the value of [o33] is set to '0'.
(If the correct procedure, communication card sets the value '0' of the function code [o33].)
 5. Set both function code value of the [o33, o34] to '0' again.
 6. Turn the inverter power OFF and then power ON.
Or send 'ResetNode' command from the CANopen master to the communications card.

Chapter 16 SPECIFICATIONS

16.1 Operating Environment

Table 16.1 lists the environmental requirements for the inverter equipped with the communications card. For the items not covered in this section, the specifications of the inverter itself apply.

Table 16.1 Environmental Requirements

Item	Specifications
Site location	Indoors
Relative humidity	5 to 95% (No condensation)
Atmosphere	The inverter must not be exposed to dust, direct sunlight, corrosive gases, flammable gases, oil mist, vapor or water drops. Pollution degree 2 (IEC60664-1) (Note) The atmosphere can contain a small amount of salt. (0.01 mg/cm ² or less per year) The inverter must not be subjected to sudden changes in temperature that will cause condensation to form.
Altitude	1,000 m max.
Atmospheric pressure	86 to 106 kPa

(Note) Do not install the inverter in an environment where it may be exposed to lint, cotton waste or moist dust or dirt which will clog the heat sink of the inverter. If the inverter is to be used in such an environment, install it in a dustproof panel of your system.

16.2 CANopen Specifications

Table 16.2 lists the CANopen specifications for this communications card. For the items not covered in this section, the specifications of the CANopen apply.

Table 16.2 CANopen Specifications

Item	Specifications	Remarks
Physical layer	CAN (ISO11898)	
Node-ID	1 to 127	Specified by inverter's function code o31.
Baud rate	20/50/125/250/500/800 kbit/s 1 Mbit/s	Specified by inverter's function code o32.
Maximum cable length	See Table 16.3.	
Applicable profile	Compliance with the following profile; - CiA DS 301 Ver. 4.02 - CiA DS 402 Ver. 2.0 with Velocity Mode	

Table 16.3 Maximum Cabling Length for CANopen Communication

Baud rate (bit/s)	20 k	50 k	125 k	250 k	500 k	800 k	1 M
Maximum cabling length	2500 m	1000 m	500 m	250 m	100 m	50 m	25 m

**CANopen 通信カード / CANopen Communications Card
"OPC -COP2"**

取扱説明書 / Instruction Manual

First Edition, July 2015
Fuji Electric Co., Ltd.

- この取扱説明書の一部または全部を無断で複製・転載することはお断りします。
- この説明書の内容は将来予告なしに変更することがあります。
- 本書の内容については、万全を期して作成いたしましたが、万一ご不審の点や誤り、記載もれなど、お気づきの点がありましたら、ご連絡ください。
- 運用した結果の影響については、上項にかかわらず責任を負いかねますのでご了承ください。

The purpose of this manual is to provide accurate information in the handling, setting up and operating of the CANopen Communications Card for the inverters for our company. Please feel free to send your comments regarding any errors or omissions you may have found, or any suggestions you may have for generally improving the manual.

In no event will Fuji Electric Co., Ltd. be liable for any direct or indirect damages resulting from the application of the information in this manual.

富士電機株式会社

パワエレ機器事業本部 ドライブ事業部
〒141-0032 東京都品川区大崎一丁目11番2号
(ゲートシティ大崎イーストタワー)

URL <http://www.fujielectric.co.jp/>

発行 富士電機株式会社 鈴鹿工場
〒513-8633 三重県鈴鹿市南玉垣町5520番地
技術相談窓口 TEL:0120-128-220 FAX:0120-128-230

Fuji Electric Co., Ltd.

Gate City Ohsaki, East Tower, 11-2, Osaki 1-chome,
Shinagawa-ku, Tokyo, 141-0032, Japan

Phone: +81 3 5435 7283 Fax: +81 3 5435 7425

URL <http://www.fujielectric.com/>
