



Starting guide ***FRENIC-Lift***

Dedicated
Inverter for Lift
Applications

3 ph 400V 4.0 kW - 45 kW
3 ph 200V 5.5 kW - 22 kW
1 ph 200V 2.2 kW



Version	Changes applied	Date	Written	Checked	Approved
0.1.0	Draft	10.05.2007	W. Zinke	W. Zinke	W. Zinke
1.0.0	1 st Release	15.08.2007	A. Schader	A. Schader	A. Schader
1.0.1	Spelling corrections	16.08.2007	A. Schader	A. Schader	A. Schader
1.0.2	Recommendations according to Lutz	20.08.2007	A. Schader	A. Schader	A. Schader
1.0.3	Added cover mounting / dismounting	20.08.2007	A. Schader	A. Schader	A. Schader
1.0.4	Recover the lift	20.08.2007	A. Schader	A. Schader	A. Schader
1.0.5	Update for 4.0, 37 and 45 kW	24.10.2007	A. Schader	A. Schader	A. Schader
1.0.6	Update 2 for 4.0, 37 and 45 kW	31.10.2007	A. Schader	A. Schader	A. Schader
1.1.0	First English version	20.11.2007	D. Bedford	D. Bedford	D. Bedford
1.2.0	Spelling corrections Most important functions in I/O terminal functions are added in table 16 200 V technical data added De-rating and over-rating added	21.02.2007	J. Alonso	D. Bedford	D. Bedford
1.2.1	Layout changes applied	27.02.2008	A. Schader	D. Bedford	D. Bedford
1.2.2	OS formula corrected	28.03.2008	J. Alonso	D. Bedford	D. Bedford
1.2.3	Caution added in chapter "conformity to European standards"	07.04.2008	J. Alonso	D. Bedford	D. Bedford
1.3.0	"Maximum braking time" changed. "Binary combination for speed selection" example modified. "Signal timing diagram for travel using intermediate speeds" updated. "Correspondence of functions for each phase of the sequence" table updated and general table added. H64, H65 & L74 added in start & stop optimization table. Figure 26 modified. Rescue operation information modified. Alarm codes updated.	14.07.2008	J. Alonso	J. Català	J. Català
1.3.1	L56 added to travel optimization table Figures 8, 9, 10 and 11 modified slightly Some information added to parameter F03	15.07.2008	J. Català	J. Català	J. Català
1.3.2	Specification tables revised Figure on page 11, 12, 18, 19, 20 and 22, slightly modified H67 definition improved on page 33 L56 definition added on page 39	16.07.2008	J. Català	J. Català	J. Català
1.3.3	Figure 23 modified Table 11 modified Title changed and text added on page 39 (soft start function) Alarm messages table modified Tables numbers corrected Small text corrections	16.07.2008	J. Alonso	D. Bedford	D. Bedford
1.4.0	No-load current calculation formula is added Table 12 is updated Function L83 is added and a value is specified in functions F20 and F25 in table 11.4 Chapter numbers are included Small text corrections	25.11.2008	J. Alonso	D. Bedford	D. Bedford
1.5.0	ROM version is included CE declaration is updated EN954-1 Cat 3 is included 2,2kW -7 is included Specifications and over-rating changed Figure 26 is changed Some text is added or modified	25.01.2010	J. Alonso	D. Bedford	D. Bedford
1.6.0	ROM version updated L07, H98(bit2) and L99(bit6) functions included Some text is added or modified Specifications modified	24.12.2010	J. Alonso	D. Bedford	D. Bedford
1.6.1	Figure numbers are restructured Figure 4 is modified Chapter 3.1 is corrected	28.02.2011	J. Alonso	D. Bedford	D. Bedford
1.6.2	Information at 15 kHz of switching frequency is added in chapter 3.3 OPL trip is included in chapter 17 Definition of parameters F03 and F04 is changed in chapters 11.2, 11.3 and 11.4 F09 is added in chapter 11.4 Some text is modified Format of tables is changed and restructured	12.03.2011	J. Alonso	D. Bedford	D. Bedford
1.7.0	EN1 and EN2 terminals included Safety standards updated Mistake corrected in figure 11 Firmware version updated ASR PI included on figure 29	04.01.2012	J. Alonso	D. Bedford	D. Bedford
1.7.1	Some information is added in Chapter 3 (safety standards) Some values updated in table 1 Some trips are included in chapter 17 Logo is updated	12.07.2012	J. Alonso	J. Català	J. Català
1.8.0	Modifications regarding L80, H04, L76 added. Some text is modified in chapter 3.1, 3.2 and 15	20.05.2014	J. Alonso	J. Català	J. Català

Dedicated to Mr. Wilfred Zinke

We would like to thank you for your valuable support and assistance in creating this Starting Guide, we are very grateful that you dedicated your time for this.

**Contents**

Chapters	Page
0. About this manual	4
1. Safety information	5
2. Conformity to European standards	7
3. Technical data	8
3.1 400 V series	8
3.2 200 V series (3ph and 1ph)	9
3.3 Over-rating in 400 V series	9
4. Removing and mounting the terminal block and front covers (5.5 to 22 kW)	10
5. Connections	11
5.1 Power connections	11
5.2 Control signals connection	12
5.3 Use of input terminals for speed set point selection	12
5.4 Control terminals description	13
a. Analog inputs	13
b. Digital inputs	13
c. Relay outputs	14
d. Transistor outputs	14
e. Communication connections (keypad, DCP 3, PC, CANopen)	15
6. Hardware configuration	16
7. Encoder	17
7.1 Standard (Built-in) input connection for 12/15 V incremental encoder	17
7.2 Option card OPC-LM1-IL for induction motors (with or without gear)	18
7.3 Option card OPC-LM1-PS1 for synchronous motors with ECN 1313 EnDat 2.1	19
7.4 Option card OPC-LM1-PR for synchronous motors with ERN 1387	20
8. Keypad operation	21
8.1 Overview	21
8.2 Keypad menus	22
8.3 Example of function setting	23
9. Signals timing diagram for normal travel using high and creep speeds	24
10. Signals timing diagram for travel using intermediate speeds	25
11. Settings	25
11.1 Introduction	25
11.2 Specific settings for induction motors (with encoder)	26
11.3 Specific settings for permanent magnet synchronous motors	27
11.4 Specific settings for induction motors in open loop (geared motors without encoder)	28
11.5 Additional settings for induction motor in open loop	29
11.6 Setting the speed profile	29
11.7 Recommended values for acceleration and deceleration related functions	31
12. Function tables	32
12.1 Travel optimization	32
12.2 Start and stop optimization	33
12.3 Additional functions and settings if needed	33
12.4 Input and output terminals function settings	34
12.5 Bit assignment of functions H98 and L99	34
13. Special operation	35
13.1 Short floor operation	35
13.2 Creepless operation	37
14. Recovering the lift from speed limiter condition	37
15. Rescue operation	38
16. Soft start for closed loop installations (IM and PMSM) with high friction	39
17. Alarm messages	40



0. About this manual

Thank you very much for choosing FRENIC-Lift inverter.

FRENIC-Lift series inverter is specially designed for operation of induction and permanent magnet synchronous motors used in lift applications. Also induction motors without encoder (open loop) can be controlled obtaining good performance and high positioning accuracy at stop.

The main characteristics of FRENIC-Lift are:

- Compact dimensions with high output power.
- Rescue operation with Battery or UPS with indication of recommended direction.
- Short floor operation with two different modes.
- 200% overload for 10 seconds.
- Communication protocols DCP 3 or CANopen integrated.
- Modbus RTU Protocol is integrated as standard.
- Incremental encoder input (12 V or 15 V / Open Collector).
- Optional cards for different encoder types (Line Driver, EnDat 2.1, SinCos...).
- Pole tuning and Auto tuning without removing the ropes (load).
- Multifunctional, detachable keypad.
- Braking transistor is integrated in all capacities.
- Operation of Induction motor without encoder (open loop) is possible.

This starting guide includes the important information and explanations about the connection and commissioning of FRENIC-Lift for elevator applications.

☞ **Inputs and outputs can be set to different functions using the corresponding functions. By factory defaults these settings are already suitable for lift applications. In this manual only the functions related to lift applications are described.**

☞ **The factory default settings are suitable for induction motors (geared). In case of gearless synchronous motors the corresponding functions have to be set. It is always possible revert the function values to factory default.**

When setting back to factory default the value of the encoder offset (function L04) is lost. In this case it is recommended to write down this value before setting to default settings, to be set back afterwards. This saves the time of making again the pole tuning procedure.



☞ **Special functions are not described which are only used in special applications. For questions please contact our technical staff.**

 **Note** This starting guide is based on firmware version 1950 and 1951 or later. For other software versions, please contact with Fuji Electric technical department.



1. Safety information

Read this manual thoroughly before proceeding with installation, connections (wiring), operation, or maintenance and inspection. Ensure you have sound knowledge of the device and familiarize yourself with all safety information and precautions before proceeding to operate the inverter. Safety precautions are classified into the following two categories in this manual.

 WARNING	Failure to heed the information indicated by this symbol may lead to dangerous conditions, possibly resulting in death or serious bodily injuries.
 CAUTION	Failure to heed the information indicated by this symbol may lead to dangerous conditions, possibly resulting in minor or light bodily injuries and/or substantial property damage.

Failure to heed the information contained under the CAUTION title can also result in serious consequences. These safety precautions are of utmost importance and must be observed at all times.

Application

 WARNING
<ul style="list-style-type: none"> • FRENIC-Lift is designed to drive a three-phase induction motor. Do not use it for single-phase motors or for other purposes. Fire or an accident could occur. • FRENIC-Lift may not be used for a life-support system or other purposes directly related to the human safety. • Though FRENIC-Lift is manufactured under strict quality control, install safety devices for applications where serious accidents or material losses are foreseen in relation to the failure of it. An accident could occur.

Installation

 WARNING
<ul style="list-style-type: none"> • Install the inverter on a non-flammable material such as metal. Otherwise fire could occur. • Do not place flammable object nearby. Doing so could cause fire.

 CAUTION
<ul style="list-style-type: none"> • Do not support the inverter by its terminal block cover during transportation. Doing so could cause a drop of the inverter and injuries. • Prevent lint, paper fibres, sawdust, dust, metallic chips, or other foreign materials from getting into the inverter or from accumulating on the heat sink. Otherwise, a fire or an accident might result. • Do not install or operate an inverter that is damaged or lacking parts. Doing so could cause fire, an accident or injuries. • Do not stand on a shipping box. • Do not stack shipping boxes higher than the indicated information printed on those boxes. Doing so could cause injuries.



1. Safety information

Wiring

WARNING

- When wiring the inverter to the power supply, insert a recommended moulded case circuit breaker (MCCB) or residual-current-operated protective device (RCD)/earth leakage circuit breaker (ELCB) (with overcurrent protection) in the path of power lines. Use the devices within the recommended current range.
- Use wires of the specified size.
- When wiring the inverter to the power supply that is 500 kVA or more, be sure to connect an optional DC reactor (DCR).
Otherwise, fire could occur.
- Do not use one multicore cable in order to connect several inverters with motors.
- Do not connect a surge killer to the inverter's output (secondary) circuit.
Doing so could cause fire.
- Ground the inverter in compliance with the national or local electric code.
Otherwise, electric shock could occur.
- Qualified electricians should carry out wiring.
- Disconnect power before wiring.
Otherwise, electric shock could occur.
- Install inverter before wiring.
Otherwise, electric shock or injuries could occur.
- Ensure that the number of input phases and the rated voltage of the product match the number of phases and the voltage of the AC power supply to which the product is to be connected.
Otherwise fire or an accident could occur.
- Do not connect the power supply wires to output terminals (U, V, and W).
- Do not insert a braking resistor between terminals P (+) and N (-), P1 and N (-), P (+) and P1, DB and N (-), or P1 and DB.
Doing so could cause fire or an accident.
- Generally, control signal wires are not reinforced insulation. If they accidentally touch any of live parts in the main circuit, their insulation coat may break for any reasons. In such a case, ensure the signal control wire is protected from making contact with any high voltage cables.
Doing so could cause an accident or electric shock.

CAUTION

- Connect the three-phase motor to terminals U, V, and W of the inverter.
Otherwise injuries could occur.
- The inverter, motor and wiring generate electric noise. Ensure preventative measures are taken to protect sensors and sensitive devices from RF noise.
Otherwise an accident could occur.

Operation

WARNING

- Be sure to install the terminal cover before turning the power ON. Do not remove the covers while power is applied.
Otherwise electric shock could occur.
- Do not operate switches with wet hands.
Doing so could cause electric shock.
- If the auto-reset function has been selected, the inverter may automatically restart and drive the motor depending on the cause of tripping.
(Design the machinery or equipment so that human safety is ensured after restarting.)
- If the stall prevention function (current limiter), automatic deceleration, and overload prevention control have been selected, the inverter may operate at an acceleration/deceleration time or frequency different from the commanded ones. Design the machine so that safety is ensured even in such cases.
Otherwise an accident could occur.
- If an alarm reset is made with the Run command signal turned ON, the inverter may start immediately. Ensure that the Run command signal is turned OFF in advance.
Otherwise an accident could occur.
- Ensure you have read and understood the manual before programming the inverter, incorrect parameter settings may cause damage to the motor or machinery.
An accident or injuries could occur.
- Do not touch the inverter terminals while the power is applied to the inverter even if the inverter is in stop mode.
Doing so could cause electric shock.



1. Safety information

CAUTION

- Do not turn the main circuit power (circuit breaker) ON or OFF in order to start or stop inverter operation.
Doing so could cause failure.
- Do not touch the heat sink and braking resistor because they become very hot.
Doing so could cause burns.
- Before setting the speeds (frequency) of the inverter, check the specifications of the machinery.
- The brake function of the inverter does not provide mechanical holding means.
Injuries could occur.

Maintenance and inspection, and parts replacement

WARNING

- Turn the power OFF and wait for at least five minutes before starting inspection. Further, check that the LED monitor is unlit and that the DC link bus voltage between the P (+) and N (-) terminals is lower than 25 VDC.
Otherwise, electric shock could occur.
- Maintenance, inspection, and parts replacement should be made only by qualified persons.
- Take off the watch, rings and other metallic objects before starting work.
- Use insulated tools.
Otherwise, electric shock or injuries could occur.

Disposal

CAUTION

- Treat the inverter as an industrial waste when disposing of it.
Otherwise injuries could occur.

Others

WARNING

- Never attempt to modify the inverter.
Doing so could cause electric shock or injuries.

2. Conformity to European standards

The CE marking on Fuji Electric products indicates that they comply with the essential requirements of the Electromagnetic Compatibility (EMC) Directive 2004/108/EC issued by the Council of the European Communities and the Low Voltage Directive 2006/95/EC.

Inverters with built-in EMC filter that bear a CE marking are in conformity with EMC directives. Inverters having no built-in EMC filter can be in conformity with EMC directives if an optional EMC compliant filter is connected to them.

General purpose inverters are subject to the regulations set forth by the Low Voltage Directive in the EU. Fuji Electric declares the inverters bearing a CE marking are compliant with the Low Voltage Directive.

FRENIC-Lift inverters are in accordance with the regulations of following council directives and their amendments:

EMC Directive 2004/108/EC (Electromagnetic Compatibility)

Low Voltage Directive 2006/95/EC (LVD)

For assessment of conformity the following relevant standards have been taken into consideration:

EN61800-3:2004

EN61800-5-1:2003

CAUTION

The FRENIC-Lift inverters are categorized as category C2 according to EN61800-3:2004. When you use these products in the domestic environment, you may need to take appropriate countermeasures to reduce or eliminate any noise emitted from these products.

3. Technical data

3.1 400 V series

Output ratings										
Type: FRN□□□ LM1S-4□	4.0	5.5	7.5	11	15	18.5	22	30	37	45
Rated voltage (V)	3-phase 380 to 480 V (Output voltage cannot be higher than input voltage)									
Rated frequency (Hz)	50-60 Hz									
Rated capacity at 440V (kVA)	6.8	10.2	14	18	24	29	34	45	57	69
Typical Motor capacity (kW)	4	5.5	7.5	11	15	18.5	22	30	37	45
Rated current (A) ¹⁾	9	13.5	18.5	24.5	32	39	45	60	75	91
Overload current rating (A)	18 for 3 s	27 for 10 s	37 for 10 s	49 for 10 s	64 for 10 s	78 for 10 s	90 for 10 s	108 for 5 s	135 for 5 s	163 for 5 s
Overload capability (%)	200% for 3 s	200% for 10 s						180% for 5 s		
Input values										
Mains supply	3-phase 380 to 480 V; 50/60 Hz; Voltage: -15% to +10%; Frequency: -5% to +5%									
External control supply	1-phase 200 to 480 V; 50/60Hz								1-phase 380 to 480V; 50/60 Hz	
Input current with DC reactor (A)	7.5	10.6	14.4	21.1	28.8	35.5	42.2	57	68.5	83.2
Input current without DC reactor (A)	13	17.3	23.2	33	43.8	52.3	60.6	77.9	94.3	114
Required power supply capacity (kVA)	5.2	7.4	10	15	20	25	30	40	48	58
Input values for battery operation										
Battery operation voltage	48 VDC or higher									
Auxiliary control power supply	1-phase 200 to 480 V; 50/60 Hz								1-phase 380 to 480 V; 50/60 Hz	
Voltage/frequency variations	Voltage: -15% to +10% (Voltage unbalance: 2% or less); Frequency: -5% to +5%									
Braking resistor values										
Maximum braking time (s)	60									
Duty cycle (%ED)	50									
Minimum resistor value ± 5% (Ω)	96	48	48	24	24	16	16	10	10	8
Options and Standards										
DC reactor (DCRE)	Optional									
EMC – Filter	Optional									
Safety standards	EN 61800-5-1, EN 61800-5-2 (SIL 2), EN ISO 13849-1 (Cat. 3, PL d)								EN61800-5-1	
Protection degree (IEC60529)	IP20							IP00		
Cooling	Fan cooling									
Mass (kg)	2.8	5.6	5.7	7.5	11.1	11.2	11.7	24.0	33.0	34.0

¹⁾ For 10 kHz Switching frequency, 45 °C ambient temperature and 80%ED

**3. Technical data****3.2 200 V series (3ph and 1ph)**

Type:	FRN□□□ LM1S-2□						FRN□□□ LM1S-7□	
Output ratings								
	5.5	7.5	11	15	18.5	22	2.2	
Rated voltage (V) ^{*1}	3-phase 200 to 240 V						1-phase 200 to 240 V	
Rated frequency (Hz)	50-60 Hz							
Rated capacity at 220V (kVA)	10.2	14	18	24	28	34	4.1	
Typical Motor capacity (kW)	5.5	7.5	11	15	18.5	22	2.2	
Rated current (A) ^{*2}	27	37	49	63	74	90	11	
Overload current rating for 10s (A)	54	74	98	126	148	180 for 5 s	22 for 3 s	
Overload capability for 10s (%)	200							
Input values								
Mains supply	3-phase 200 to 240 V; 50/60 Hz; Voltage: -15% to +10%; Frequency: -5% to +5%						1-phase 200 to 240V; 50/60Hz; Voltage: -15% to +10%; Frequency: -5% to +5%	
External control supply	200 to 240 V; 50/60 Hz							
Input current with DC reactor (A)	21.1	28.8	42.2	57.6	71	84.4	17.5	
Input current without DC reactor (A)	31.5	42.7	60.7	80.1	97	112	24	
Required power supply capacity (kVA)	7.4	10	15	20	25	30	3.5	
Input values for battery operation								
Battery operation voltage	24 VDC or higher							
Auxiliary control power supply	1-phase 200 to 240 V; 50/60 Hz ; Voltage: -15% to +10%; Frequency: -5% to +5%							
Braking resistor values								
Maximum braking time (s)	60							
Duty cycle (%ED)	50							
Minimum resistor value ± 5% (Ω)	15	10	7.5	6	4	3.5	33	
Options and Standards								
DC reactor (DCRE)	Optional							
EMC – Filter	Optional							
Safety standards	EN 61800-5-1, EN 61800-5-2 (SIL 2), EN ISO 13849-1 (Cat. 3, PL d)							
Protection degree (IEC60529)	IP20							
Cooling	Fan cooling							
Mass (kg)	5.6	5.7	7.5	11.1	11.2	11.7	3.0	

^{*1} Output voltage cannot be higher than input voltage

^{*2} For 10 kHz Switching frequency, 45 °C ambient temperature and 80%ED

3.3 Over-rating for 400 V series

In table 1, different ratings are shown depending on the switching frequency.

Table 1. Over-rating for 400 V series

Size INVERTER	Maximum Motor POWER	40%ED 45 °C								
		Switching frequency: 10 kHz			Switching frequency: 12 kHz			Switching frequency: 15 kHz		
		I rated (A)	Overload (%)	Time (s)	I rated (A)	Overload (%)	Time (s)	I rated (A)	Overload (%)	Time (s)
4.0	4 kW	10.6	170	3	10	180	3	9.5	190	3
5.5	5.5 kW	17.6	170	10	15	180	10	14.2	190	10
7.5	7.5 kW	24.1	170	10	20.5	180	10	19.4	190	10
11	11 kW	30.5	170	10	27.2	180	10	25.7	190	10
15	15 kW	37.6	170	10	35.6	180	10	33.6	190	10
18.5	18.5 kW	45	170	10	43.4	180	10	41	190	10
22	22 kW	54.8	170	10	50	180	10	47	190	10
30	30kW	63.5	170	5	60	180	5	60	180	5
37	37 kW	79.5	170	5	75	180	5	75	180	5
45	45 kW	96	170	5	91	180	5	91	180	5

4. Removing and mounting the terminal block and front covers (5.5 to 22 kW)

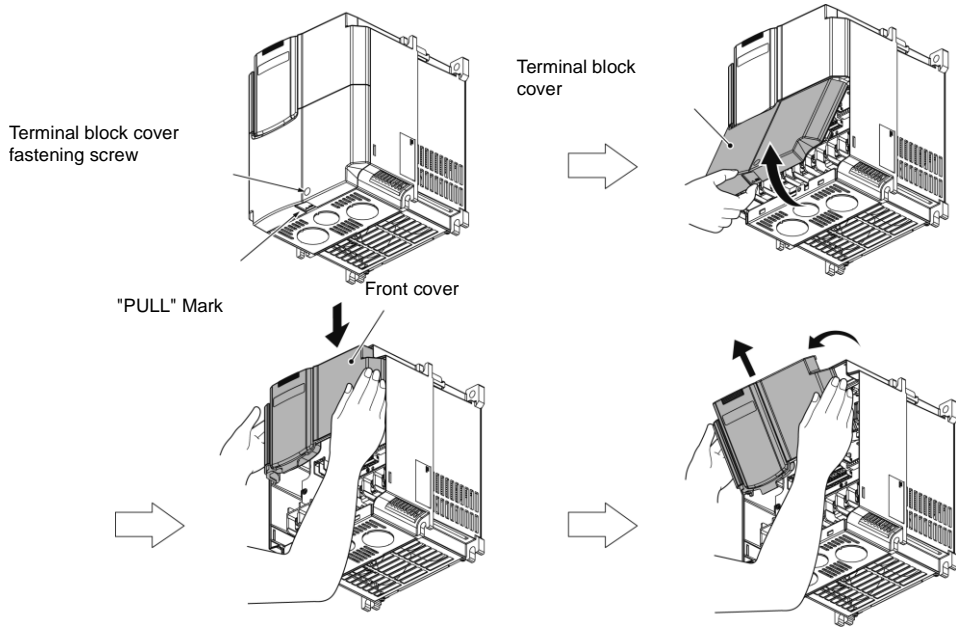

Figure 1: Removing the terminal block cover and the front cover

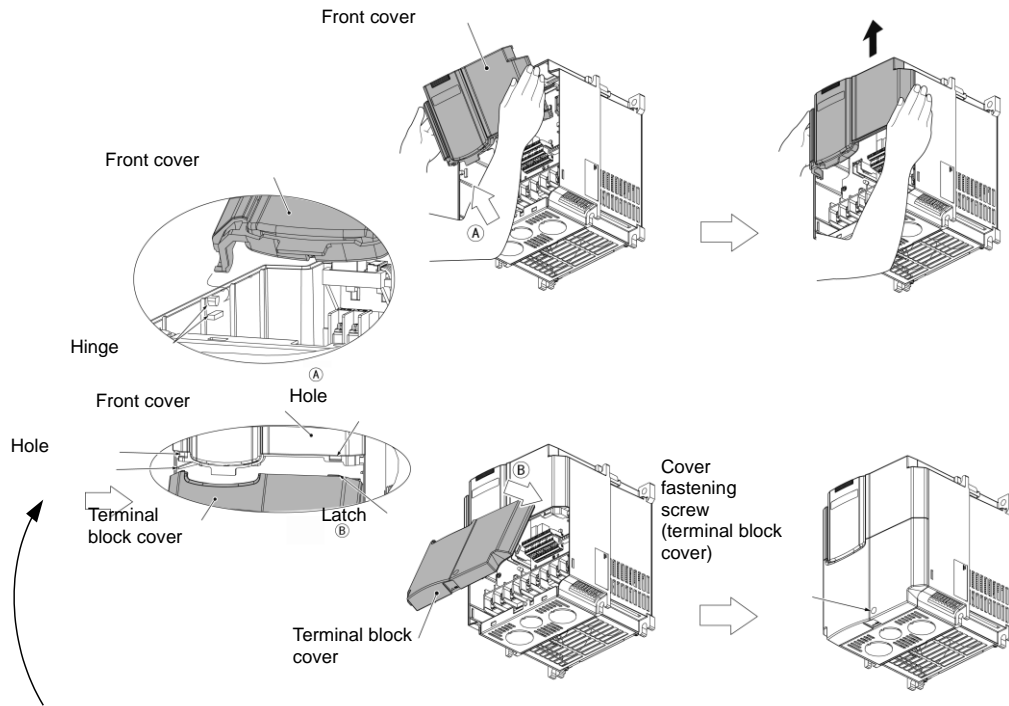

Figure 2: Mounting the terminal block cover and the front cover

5. Connections

5.1 Power connections

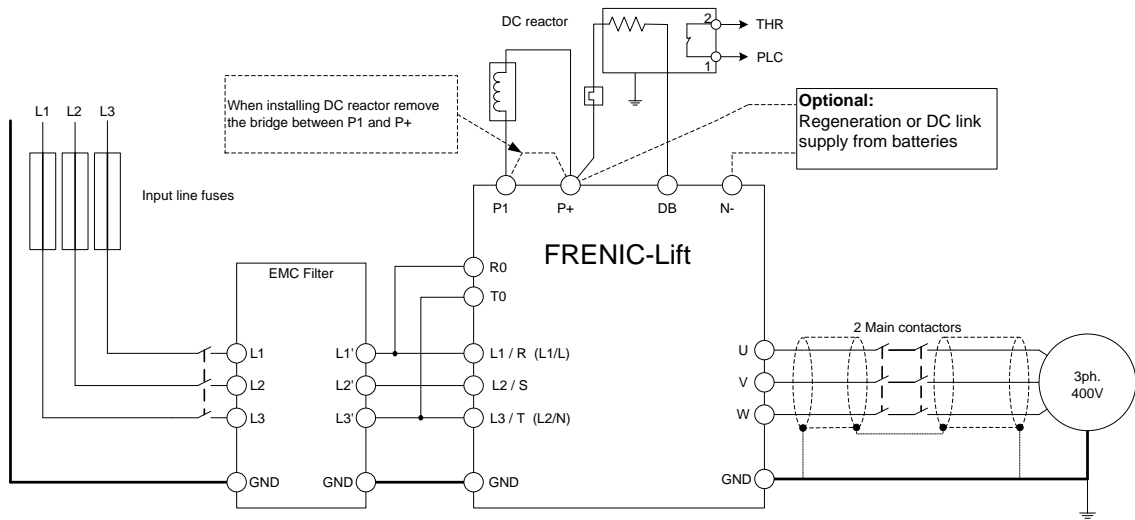

Figure 3. Power connections

Table 2. Power terminals description

Terminal label	Description of the power terminals
L1/R, L2/S, L3/T (L1/L, L2/N)	3-phase supply input from EMC filter, main contactors and main safety (1-phase supply input from EMC filter, main contactors and main safety)
U, V, W	3-phase motor connection for induction or permanent magnet synchronous motors
R0, T0	Auxiliary supply for inverter control circuit. In case of FRN37LM1S-4 and FRN45LM1S-4, those terminals supply also fans and MC contactor for charging circuit. In this case 380 V must be supplied. Only one terminal R0 and T0 must be supplied
P1, P(+)	DC reactor connection
P(+), N(-)	Connection of an optional regeneration unit or DC link supply from batteries, for example for rescue operation
P(+), DB	Connection of external braking resistor
G x 2	2 terminals for the connection of the inverter enclosure with the protecting earth Attention! It is only allowed to connect one wire to each terminal

- ⚡ Please connect the screen in both motor and inverter sides. Ensure that the screen is continued also through the main contactors.
- ⚡ It is recommended to use a braking resistor with clixon and connect the fault signal to the controller and also to the inverter, configuring a digital input with External alarm function. To do so, set the related function (E01 to E08) to 9.
- ⚡ It is recommended the use of a thermal relay in the braking resistor circuit. This relay should be set up that it only trips in the case that there is a short circuit in the braking transistor.

Optional: Connection of UPS for rescue operation (example)

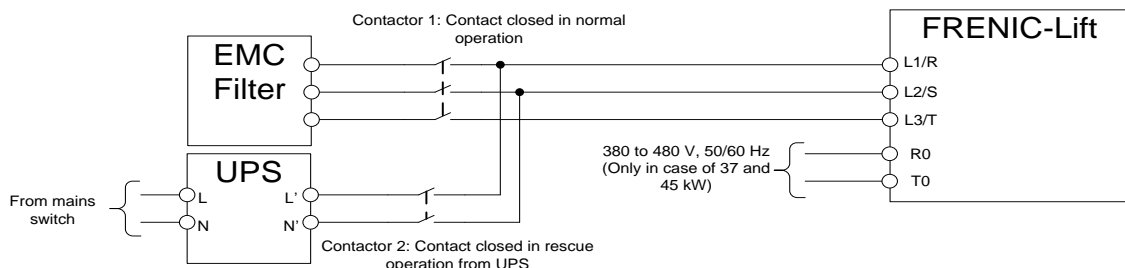

Figure 4. Connection of UPS for rescue operation

This is only a schematic drawing. This is for information only and without responsibility. The start of rescue operation, enable signal activation and main contactors control is handled by the lift controller and is not in the range of the responsibility of the inverter.

5. Connections

5.2 Control signals connection

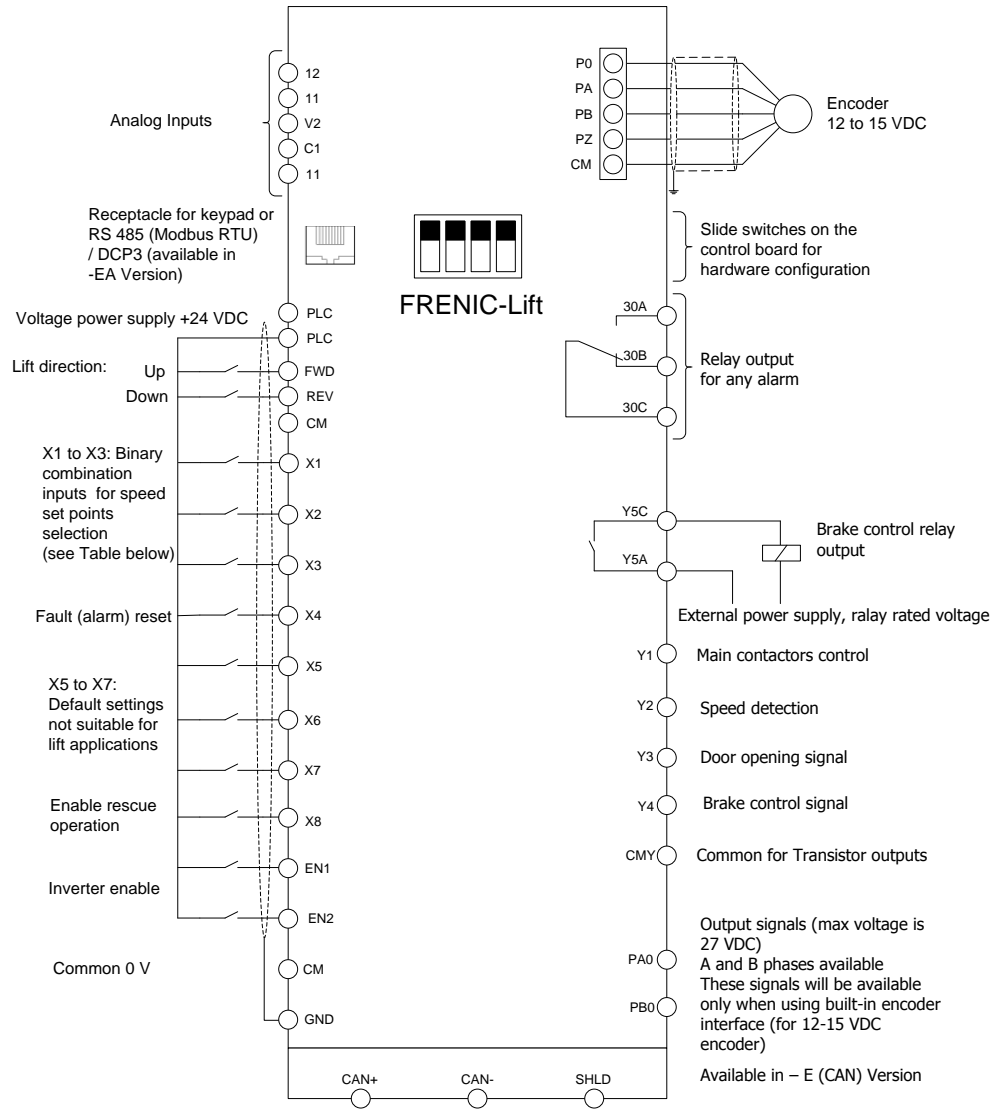

Figure 5. Control signals connection

⚡ Digital inputs and outputs and relay outputs can be configured for alternative functions. The functions described in the schematic diagram are the factory settings of FRENIC-Lift

5.3 Use of input terminals for speed set point selection

Table 3: binary combination for speed selection

SS4 (X3)	SS2 (X2)	SS1 (X1)	Binary speed coding function	Value	Selected Speed	Speed set point function
0	0	0	L11	0 (000)	Zero speed	C04
0	0	1	L12	1 (001)	Intermediate speed 1	C05
0	1	0	L13	2 (010)	Inspection speed	C06
0	1	1	L14	3 (011)	Creep speed	C07
1	0	0	L15	4 (100)	Intermediate speed 2	C08
1	0	1	L16	5 (101)	Intermediate speed 3	C09
1	1	0	L17	6 (110)	Intermediate speed 4	C10
1	1	1	L18	7 (111)	High speed	C11

See also functions E01-E04.

5. Connections

In case you want to use a different binary combination for a speed set point function it is possible by means of changing binary speed coding functions (L11-L18).

Table 4: Example of binary combination for speed selection

SS4 (X3)	SS2 (X2)	SS1 (X1)	Binary speed coding function	Value	Selected Speed	Speed set point function
0	0	0	L11	0 (000)	Zero speed	C04
1	1	1	L12	7 (111)	Intermediate speed 1	C05
0	1	0	L13	2 (010)	Inspection speed	C06
0	1	1	L14	3 (011)	Creep speed	C07
1	0	0	L15	4 (100)	Intermediate speed 2	C08
1	0	1	L16	5 (101)	Intermediate speed 3	C09
1	1	0	L17	6 (110)	Intermediate speed 4	C10
0	0	1	L18	1 (001)	High speed	C11

5.4 Control terminals description

a. Analog inputs

Using analog inputs the motor speed and the torque bias can be set without steps (stageless).

b. Digital Inputs

The digital inputs can operate using NPN or PNP logic. The selection of the logic is set using slide switch SW1 located on the control PCB. **Factory setting is PNP (Source) Logic.**

Connection example using PNP Logic:



Figure 6: Normal connection using free potential contacts of the lift controller.

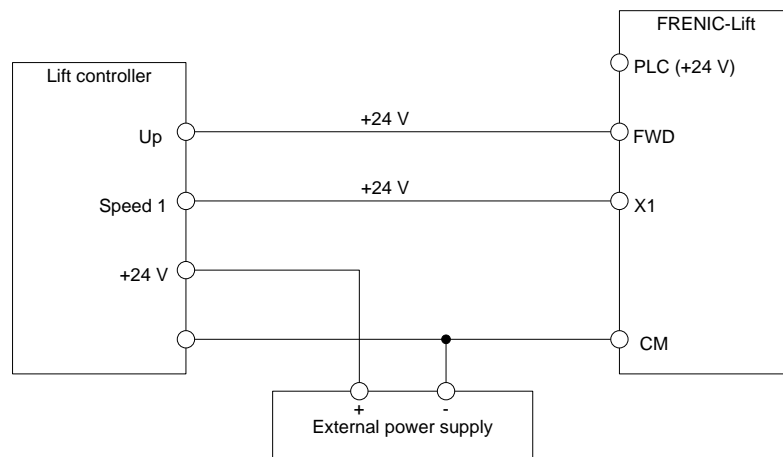

Figure 7: Connection using external power supply

5. Connections

Table 5: Description of transistor inputs (optocoupled inputs)

Terminal	Function description of the digital inputs
FWD	Left rotation direction of the motor seen from the shaft side. Depending on the mechanical set up this can be UP or DOWN direction of the cabin
REV	Right rotation direction of the motor seen from the shaft side. Depending on the mechanical set up this can be DOWN or UP direction of the cabin.
CM	Common 0 V
X1 to X3	Digital inputs for speed selection. From binary combination 7 different speeds can be selected.
X4 to X7	Digital inputs from X4 to X7 are not configured from factory for standard Lift applications and are not normally used. With these inputs additional applications can be implemented. For example, X6 input can be configured for the failure of the braking resistor (THR: external alarm).
X8	Configured from factory as "BATRY" for Battery or UPS operation.
EN1 & EN2	Inverter output stage enable. Cancellation of any of these signals during travel stops immediately the motor (brake signal is turned OFF).

Electrical specification of digital inputs using PNP (Source) Logic is shown in table 5.

Table 6. Digital inputs electrical specification

Item	Status	Range
Voltage	ON	22 to 27 V
	OFF	0 to 2 V
Current	ON	Min. 2.5 mA Max. 5.0 mA

c. Relay outputs (both can be programmed)

Table 7. Default setting and specifications of relay outputs

Terminals	Function description of the relay outputs
30A; 30B and 30C	Inverter alarm. Switching contact. In case of fault, the motor stops and the contact 30C-30A switches. Contact rating: 250 VAC; 0.3 A/48 VDC; 0.5A
Y5A-Y5C	Motor brake control. Start: After start giving current to the motor the output will be activated (brake released). Stop: After reaching zero speed the output will be deactivated (brake applied). Contact rating: 250 VAC; 0.3 A/48 VDC; 0.5A

d. Transistor outputs

Terminals Y1 to Y4 are configured from factory with the functions described in the table below. Other functions can be set using functions E20 to E23.

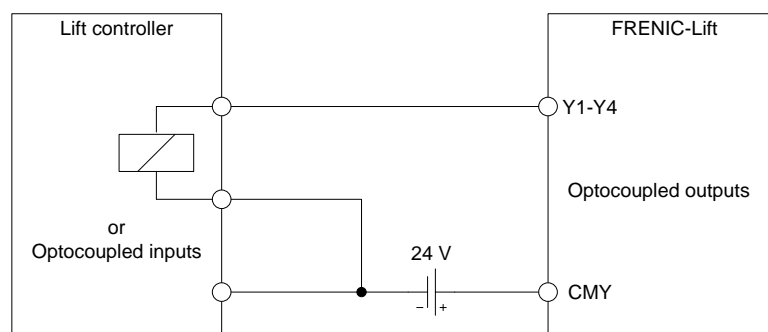

Figure 8: Connection using PNP (Source) Logic

5. Connections

Table 8. Default setting and specifications of transistor outputs

Terminal	Function description of the transistor outputs
Y1	Main contactors control. Normally the lift controller will also determine the status of the main contactors (depending on the safety chain status).
Y2	Anticipated door opening signal (the door starts to open meanwhile the lift is still in motion). To set up use functions L87 , L88 and L89 .
Y3	Speed detection signal (FDT). To set up use functions E31 and E32 .
Y4	Motor brake control. Normally the lift controller will also determine the status of the motor brake (depending on the safety chain status).
CMY	Common for transistor outputs

Electrical specification of transistor outputs is shown in table 9.

Table 9. Output transistors electrical specification

Item	Status	Range
Voltage	ON	2 to 3 V
	OFF	24 to 27 V
Operation current	ON	Max. 50 mA
Leakage current	OFF	0.1 mA

Maximum connectable voltage is 27 VDC – inductive loads should not be connected directly (they should be connected through a relay or optocoupler)

e. Communication connections (keypad, DCP 3, PC, CANopen)

FRENIC-Lift has one RS485 port and one CAN port available for communication.

The RS485 port (through a RJ-45 connector) makes possible the connection of the FRENIC-Lift keypad, a PC or the connection with a controller through DCP 3 communication. Only one communication is possible at the same time.

i. Keypad

The keypad can be remotely connected up to 20 m.

Table 10: RJ-45 connector pin assignment

Pin Nr.	Signal	Function	Comments
1 and 8	VDC	Keypad power supply	5 V
2 and 7	GND	Common for VDC	Ground (0 V)
3 and 6	None	Free	Not used
4	DX-	RS485 data (-)	When the keypad is connected, SW3 switch on the control board must be set to OFF position (Factory set). For the connection of a Laptop or DCP 3 communication SW3 switch must be set to ON position.
5	DX+	RS485 data (+)	

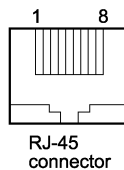

Figure 9: RJ-45 connector (inverter)

ii. DCP 3 communication

If the controller supports DCP 3 protocol, the most important operations can be done using the keypad of the lift controller.

Only pins 4 and 5 of the RJ-45 connector are used for signals DATA- (DX-) and DATA+ (DX+) respectively (see table 10).

5. Connections

iii. Connection with PC

LIFT LOADER is a PC program available, giving a comfortable tool for the inverter set up and diagnosis. The connection is done through the RS 485 port (on the RJ-45 connector). For the connection through the USB port of a PC, a USB-RS485 converter is needed, like for example EX9530 (Expert).

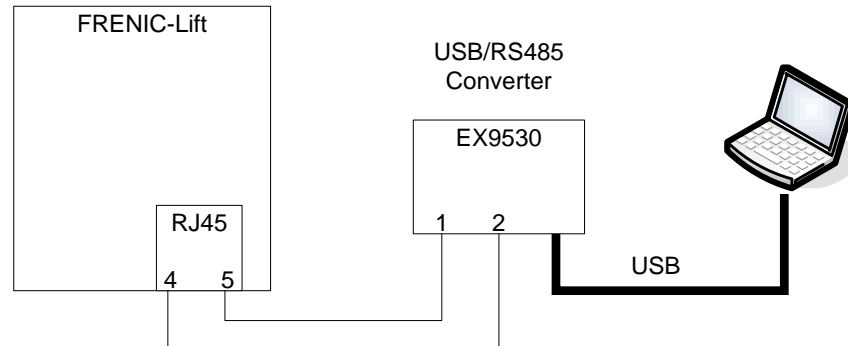

Figure 10: Connection of FRENIC-Lift with PC

iv. CAN connection

CAN+ and CAN- on the control board are dedicated to CAN communication. The CAN cable shield may be connected to terminal SHLD (also to GND terminal). Terminal 11 is CAN_GND.

6. Hardware configuration

Slide switches for different function settings

On the control board we can find 4 slide switches. With these switches different configurations can be set. From factory (default) these switches are configured as follows.

Table 11: Configuration of the slide switches

Configuration / Meaning	Slide switches factory setting	Possible configuration
Digital inputs in PNP Logic (Source)	SW1=SOURCE	
Digital inputs in NPN Logic (Sink)		SW1=SINK
RJ 45 connector with keypad attached	SW3=OFF	
RJ 45 connector when connecting PC		SW3=ON
V2-11 used as analog input (0-±10 VDC)	SW4=V2	
PTC connection in analog input V2-11		SW4=PTC
For encoders with 12 V supply voltage	SW5=12 V	
For encoders with 15 V supply voltage		SW5=15 V

⚡ It is not needed to set slide switch SW5 for standard encoders with supply voltages from 10 to 30 V.

⚡ By using the PTC input, the cut-off (stopping) function of the inverter does not fulfil EN81-1.

7. Encoder

7.1 Standard (Built-in) input connection for 12/15 V incremental encoder

FRENIC-Lift control board includes the interface for the connection of an encoder for applications with induction machines. The connection is done using screw terminals.

The output supply voltages 12 or 15 VDC are compatible with standard encoders HTL 10-30 VDC. Pulse resolution from 360 to 6000 can be set using function L02.

Table 12: Encoder technical requirements

Property	Specification	
Supply voltage	12 or 15 VDC±10%	
Output signal connection	Open Collector	Push pull
Maximum input frequency	25 kHz	100 kHz
Maximum cable length	20 m	
Minimum detection time for Z Phase	5 μs	

Table 13: Required signals and their meaning

Signal	FRENIC-Lift Terminal	Meaning
A – Phase	PA	Pulses phase A
B – Phase	PB	Pulses phase B 90° shifted
+UB	PO	Power supply 12 or 15 VDC
0V	CM	Common 0 V
Z	PZ	Marker

Output signals

The signals from A phase and B phase are available as output signals on terminals PAO and PBO, to be used by the lift controller.

The maximum connectable voltage is 27 VDC and the maximum allowed output current is 50 mA.

Supply voltage

The supply voltage of the encoders can be selected by setting the slide switch SW5 located in the inverter control board. Factory setting is 12 V, which can be used for standard encoders with supply voltages from 10 to 30 VDC.

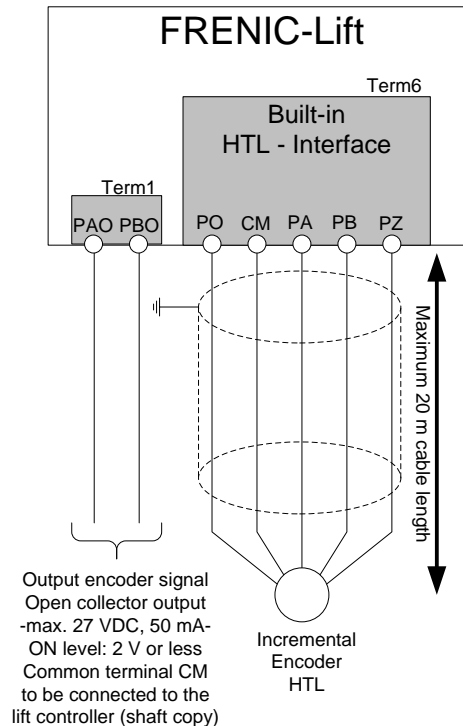

Figure 11: Connection using HTL encoder interface

The encoder cable must be always shielded. The shield must be connected in the inverter side and the encoder side using the ground terminal or dedicated terminal.

7. Encoder

7.2 Option card OPC-LM1-IL for induction motors (with or without gear)

Application:

- For induction motors with or without gear
- The feedback encoder of the motor is line driver TTL (differential signal + 5 VDC)
- When the encoder signals are also connected (used by) the lift controller

Encoder technical data:

- Supply voltage: +5 VDC $\pm 5\%$
- 2 signals with 90° phase shift (A, \bar{A}, B, \bar{B})
- Maximum input frequency: 100 kHz
- Recommended pulse count: 1024 or 2048 pulses/rev (with high efficiency gearboxes it is highly recommended to use encoders with 2048 pulses/rev)

Other characteristics and application requirements:

- Maximum cable length: 20 m
- Use only shielded cables

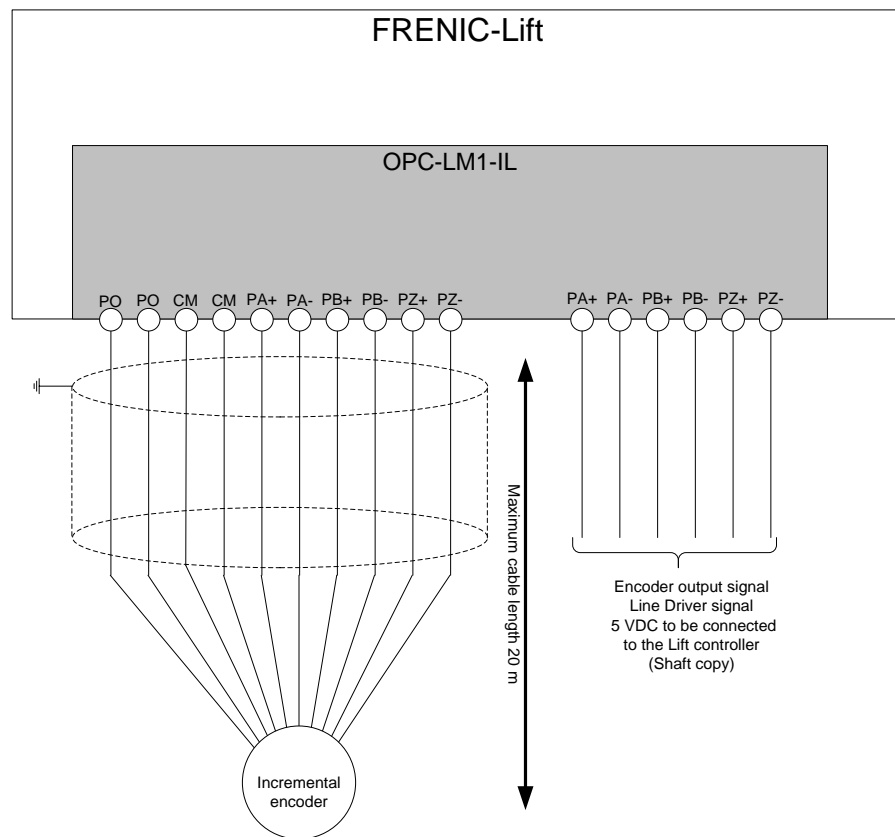

Figure 12: Option board connection

Table 14: OPC-LM1-IL connection terminals meaning

Terminal/signal names	Description
P0	Encoder voltage supply 5 VDC (maximum current 300 mA)
CM	Common 0 V
PA+	Phase A (square pulse)
PA-	Phase A inverted (square pulse)
PB+	Phase B (square pulse)
PB-	Phase B inverted (square pulse)
PZ+	Phase Z (square pulse)
PZ-	Phase Z inverted (square pulse)

⚡ The signal names may be different depending on the encoder manufacturer.

7. Encoder

7.3 Option card OPC-LM1-PS1 for synchronous motors

Application:

- For permanent magnet synchronous motors (gearless)
- For encoder Heidenhain type ECN1313 or ECN413 or ECN113 EnDat 2.1

Other characteristics and application requirements:

- Output signal: 2048 Sin/Cos pulses (periods) per revolution
- Operating voltage: 5 VDC±5%; 300 mA
- Data connection: EnDat 2.1

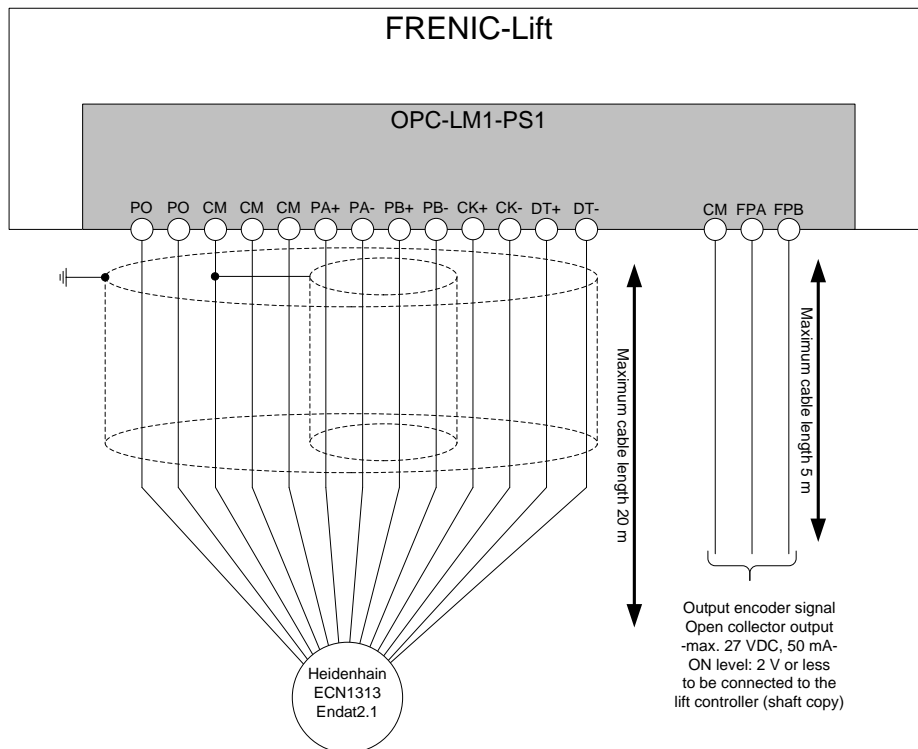

Figure 13: OPC-LM1-PS1 option card connection

Table 15: Meaning of the connection terminals of OPC-LM1-PS1

Terminal name in the option card	Signal name of Heidenhain	Description
P0	Up and Up Sensor	Supply voltage 5 V, connection of Up Sensor mandatory for cable length >10 m
CM	0V (Up) and 0V Sensor	Common 0 V for the power supply
PA+	A+	A signal
PA-	A-	A signal inverted
PB+	B+	A signal
PB-	B-	A signal inverted
CK+	Clock+	Clock signal for serial communication
CK-	Clock-	Clock signal inverted for serial communication
DT+	DATA+	Data line for communication of the absolute information
DT-	DATA-	Data line inverted for communication of the absolute information

- ⚡ This option card is delivered in a separate box. An instruction manual is included in this box.
- ⚡ Prior to the commissioning the encoder resolution (pulses per revolution) has to be set always using function L02.
- ⚡ For synchronous motors it is also necessary to set the encoder type in function L01.

7. Encoder

7.4 Option card OPC-LM1-PR for synchronous motors

Application:

- For permanent magnet synchronous motors
- For encoder Heidenhain type ERN1387 or ERN487 or compatible

Other characteristics and application requirements:

- Output signal: 2048 Sin/Cos pulses (periods) per revolution
- Operating supply voltage: 5 VDC±5% (maximum current is 300 mA)
- Absolute signal: 1 Sin/Cos signal with 1 Period/rev

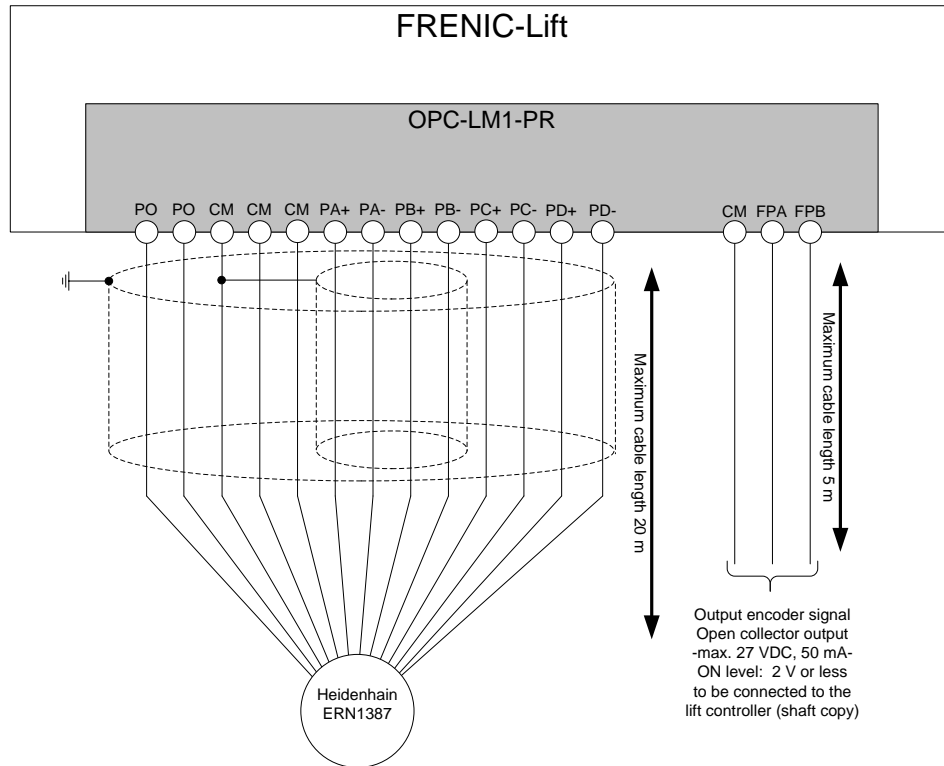

Figure 14: Connection option card OPC-LM1-PR

Table 16: Meaning of the connection terminals of OPC-LM1-PR

Terminals description in the option card	Signal name of Heidenhain	Description
P0	Up and Up Sensor	Supply voltage 5 V, connection of Up Sensor mandatory for cable length >1 0m
CM	0V (Up) and 0V Sensor	Common 0 V for the power supply
PA+	A+	A phase
PA-	A-	A phase inverted
PB+	B+	B phase
PB-	B-	B phase inverted
PC+	C+	C phase (Absolute signal)
PC-	C-	C phase inverted (Absolute signal)
PD+	D+	D phase (Absolute signal)
PD-	D-	D phase inverted (Absolute signal)

- ⌘ This option card is delivered in a separate box. An instruction manual is included in this box.
- ⌘ Prior to the commissioning the encoder resolution (pulses per revolution) has to be set always using function L02.
- ⌘ For synchronous motors it is also necessary to set the encoder type in function L01.
- ⌘ Also can be applied to induction motors (only PA and PB are used in this case, L01= 0)
- ⌘ Is not recommended to use this kind of encoders with pole motors > 24

8. Keypad operation

8.1 Overview

To operate, commission and set up FRENIC-Lift inverter there are two possibilities: using inverter keypad TP-G1-ELS or PC. For operation using a PC it is necessary to use the dedicated software **Lift Loader**. This software is free of charge and can be downloaded from our website www.fujielectric-europe.com. The keypad is connected to the inverter through the RJ-45 connector. This connection is also used for the connection with the PC or the lift controller using DCP 3 protocol.

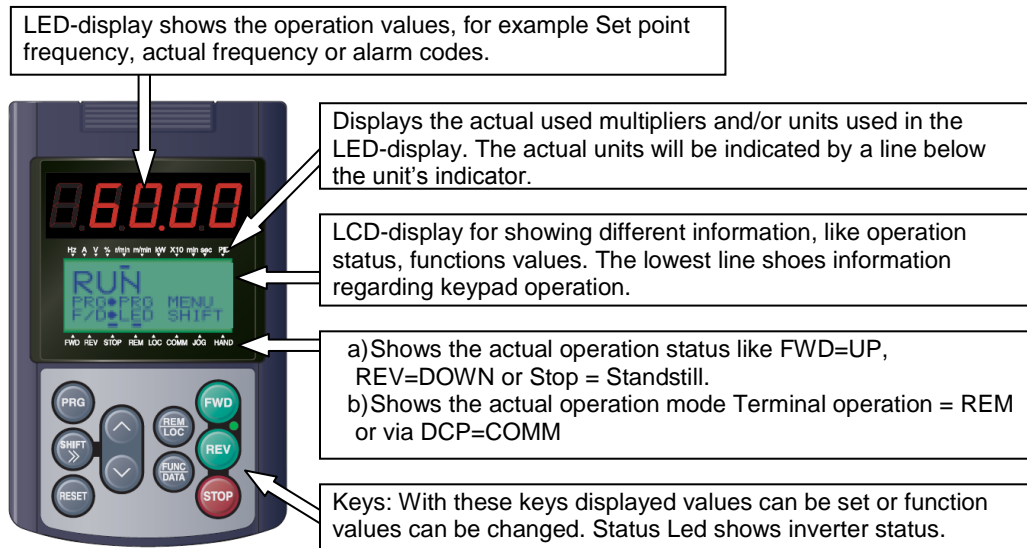

Figure 15: Overview of keypad TP-G1-ELS

Table 17: Keypad keys explanation

Key	Description
	Use this key to change between operation and programming mode.
	Use this key to move the cursor to the right in programming mode.
	In Alarm mode: Alarm reset In Programming mode: leave and discard the change in the settings.
	In Programming mode: Function selection inside the menu or change the function value In operation mode: changing the set point frequency in keypad operation. Not for elevator applications! In Programming mode: leave and discard the change in the settings.
	In Programming mode: Parameter edit or saving In Operation mode: for choosing the displayed value (and units).
	Change between Remote (Terminal control) and Local (keypad operation).
	These 3 keys may not be used in lift application. In local mode with these keys the motor can be started and/or stopped.
	Lights while a run command is supplied to the inverter.

8. Keypad operation

8.2 Keypad menus

The complete menus list can be accessed by pressing **PRG** key. The LCD display shows the 4 first menus from the complete list.

- | |
|---------------|
| 1. DATA SET |
| 2. DATA CHECK |
| 3. OPR MNTR |
| 4. I/O CHECK |
| 5. MAINTENANC |
| 6. ALM INF |
| 7. ALM CAUSE |
| 8. DATA COPY |
| 9. LOAD FCTR |

Figure 16: Complete menus list

Detailed menus description

1. DATA SET

This is the important menu for commissioning. It displays the function codes list. Every function has a number and name assigned. After selecting a function it can be checked and/or changed (edited) if needed by pressing  key.

2. DATA CHECK

Also using this menu functions codes can be changed. In this menu only function codes numbers are shown (without the names) and the set values can be directly read. Changed function values from default are indicated by a star on the right side of the parameter number. By pressing  the selected function can be changed (edited).

Figure 17: DATA CHECK menu.

Function changed and saved

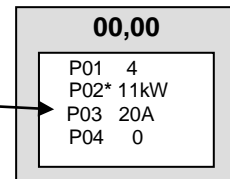

3. OPR MNTR (OPERATION MONITOR)

In this menu different operating values can be shown in the LCD display. There are 4 different screens showing 4 lines each, for example output frequency, output current, output voltage and calculated torque.

4. I/O CHECK

For checking, if FRENIC-Lift is receiving the correct control signals from the lift controller and the output signals are issued correctly. Input and output signals are displayed in different screens.

Figure 18: Example with digital inputs display. In this Example X2 and FWD inputs are active.

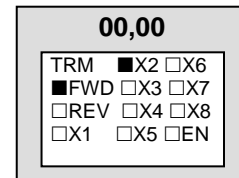

5. MAINTENANC (MAINTENANCE)

Shows the inverter condition: runtime, main capacitors capacitance, firmware version.

6. ALM INF (ALARM INFORMATION)

In this menu the alarm memory is shown. After the selection of an alarm by pressing  key the most relevant information of this alarm is shown.

8. Keypad operation

7. ALM CAUSE (ALARM CAUSE)

In this menu the possible alarm causes are shown. After the selection of an alarm by pressing a possible causes of this alarm is shown.

8. DATA COPY

With this menu complete inverter function set up can be transferred from one inverter to another. This may be helpful to set up different installations with the same motor and same characteristics. Be aware that function protection (F00) is no copied. Motor data and communication set are copied only between inverters of same range.

9. LOAD FCTR (LOAD FACTOR)

In this menu the maximum current, the average current and the average braking torque during a preset measuring time can be measured in the real application.

8.3 Example of function setting

Figure 19: LCD display of the first 4 menus after pressing key

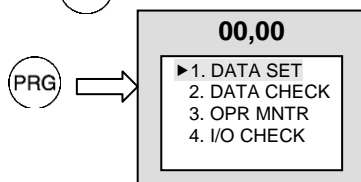

Figure 20: Menu selection (in this figure maintenance menu is selected)

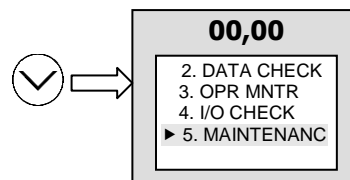

Figure 21: Selection of Menu 1

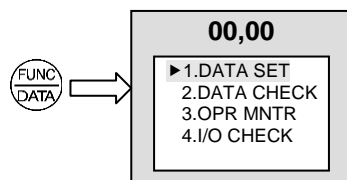

Figure 22: Function code selection. In this figure **P03 Rated current** from the P Group (Motor functions)

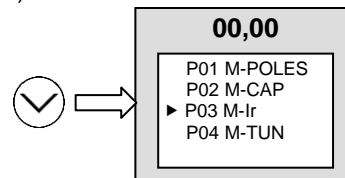

Figure 23: To edit (go inside) the function

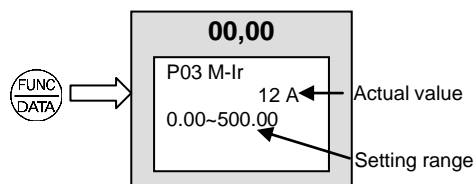
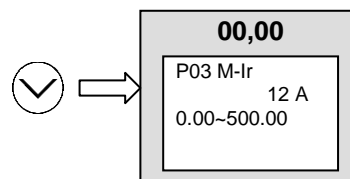

Figure 24: Changing the value of P03 (motor rated current), in this example to 12.



After changing the value using the arrow keys, it can be saved by pressing key.

Cancellation without saving is possible by pressing key.

9. Signal timing diagram for normal travel using high and creep speeds

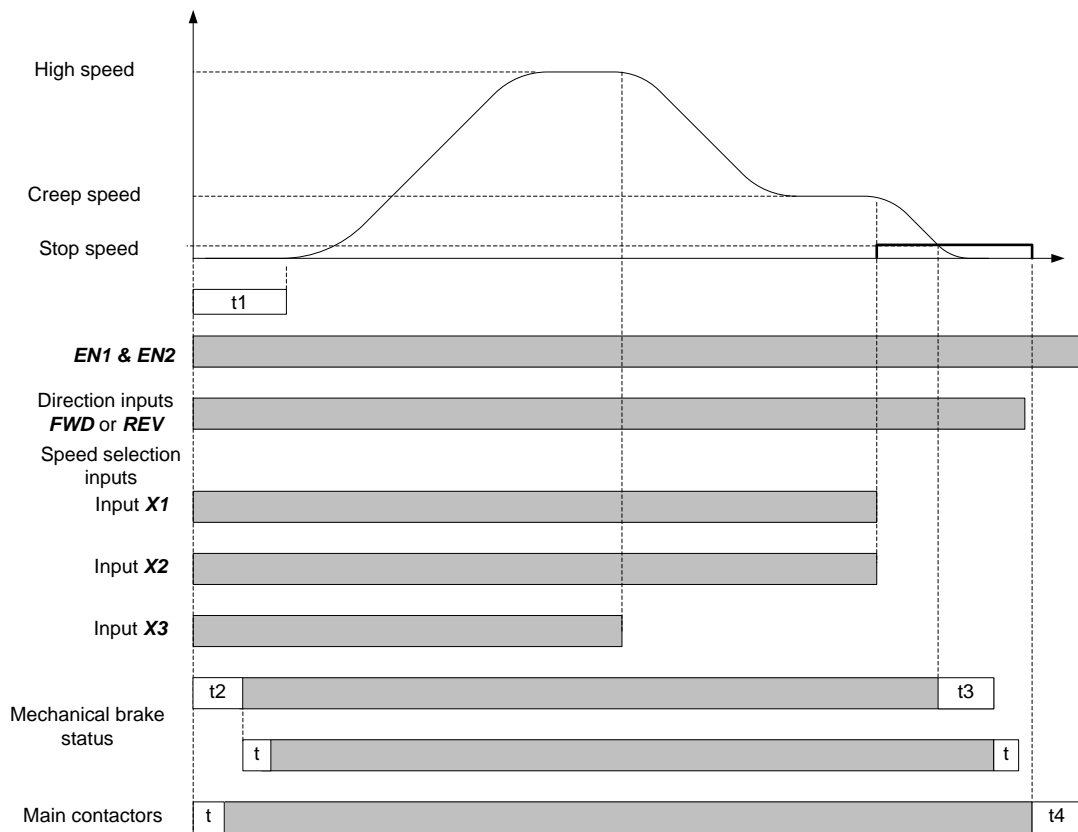

Figure 25. Signal timing diagram for normal travel.

Sequence description

Start:

By activating FWD (UP) or REV (DOWN) terminal and EN1 and EN2 (enable) terminals, t1 and t2 times start to run. During that time, terminals X1 to X3 (speed selection) can be activated. After the completion of time t2 the output of brake control will be activated and the mechanical brake opens (releases) after some time (delay time to the reaction of contactors, coil...). After completion of time t1, the speed set point will be used and the lift will start to move accelerating to reach high speed (normal case).

Stop:

The terminal X3 will be deactivated by the lift controller (from the internal settings of the controller). After finishing the deceleration the lift will reach creep speed (set point activated by inputs X1 and X2). After reaching the floor level, also creep speed will be deactivated. After the deceleration the cabin will reach zero speed. In this moment t3 begins to run. After time t3, the brake output is deactivated (and brake will be applied).

⚡ To control the main contactors the transistor output Y1 can also be used. With this it is ensured that the main contactors are opened always after the brake is closed.

Table 18. Description of times shown in figure 25

Time	Function	Description
t	----	Response times (different values) of the brake and main contactors
t1	F24	Time to start to move
t2	L82	Time to release (open) the brake
t3	L83	Time to apply (close) the brake
t4	Controller	Time delay from deactivating enable to opening the main contactors

10. Signal timing diagram for travel using intermediate speeds

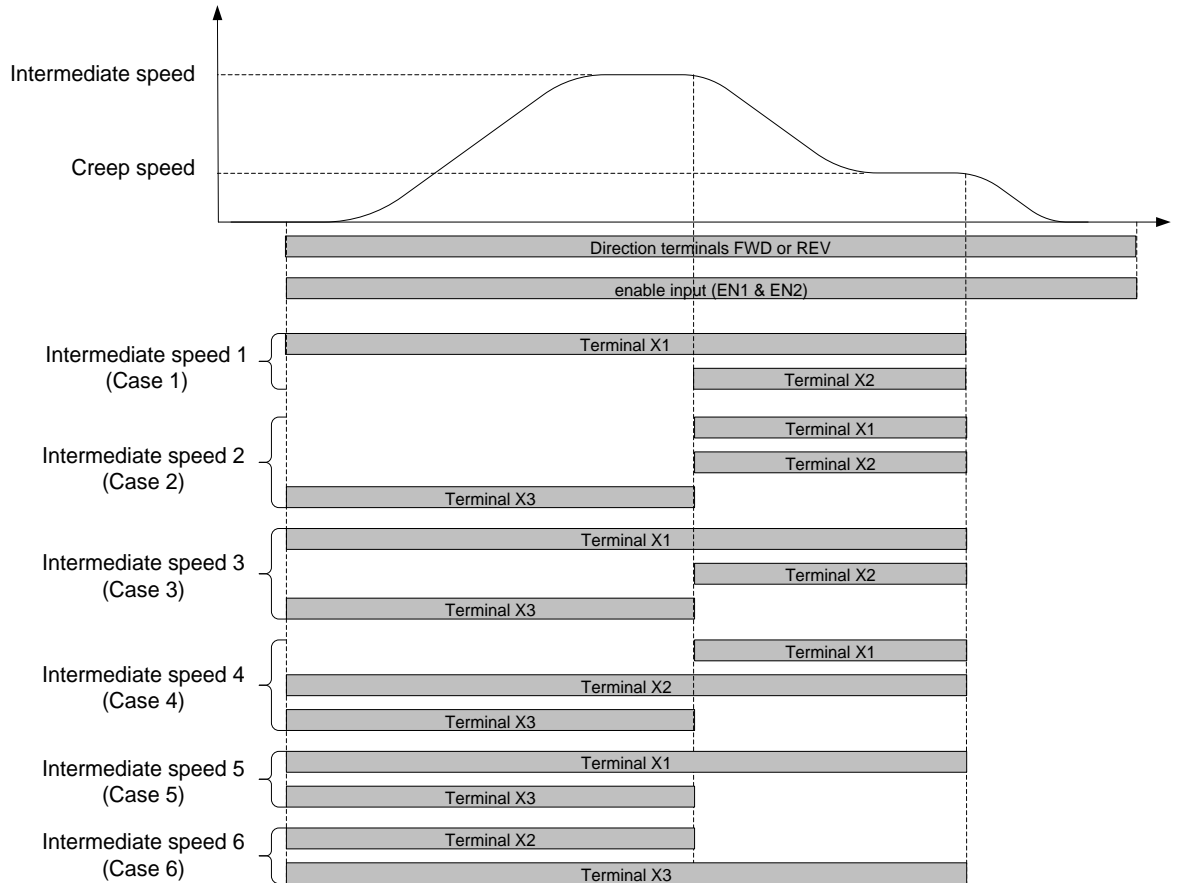

Figure 26. Signal timing diagram for travel using intermediate speeds.

11. Settings

11.1 Introduction

The set up of the inverter depending on the application is done using several inverter functions. Especially the motor and speed profile related functions have to be adjusted depending on the application. All these functions must be set up according to known motor and installation data before the first travel. The optimization of the travel is done after that and after the complete assembly of the lift installation.

The first travel for checking if the motor control is good, SHOULD BE ALWAYS done by controlling the lift from outside the cabin (typically RESCUE operation).

Step by step procedure

1. Ensure that the encoder is connected properly and that the encoder used is suitable for the motor used (check also the chapters for **Encoder** and **Connections**). The screen of the encoder cable must be connected to earth in BOTH, motor and inverter side.
2. Ensure that the motor cables are connected to U,V,W terminals and that the screen of the motor cable must be connected to earth in BOTH, motor and inverter side.
3. Ensure that the protective earth of the installation is connected to the inverter and motor.
4. Ensure that the braking resistor is connected properly to the inverter and protective earth.
5. Ensure that the control signals **FWD or REV; X2 and EN1 and EN2** become active by using rescue operation (controlling the lift from outside the cabin). Ensure that the output signals for brake control on terminal **Y5C** and –if main contactors are controlled by the inverter- the signal on terminal **Y1** becomes active. The status of the signals can be checked using the LCD display; for more information please check the chapter related to Keypad operation.
6. Function settings (see following pages for induction motors and permanent magnet synchronous motors)
7. Perform auto tuning for induction motors or pole tuning for permanent magnet synchronous motors.
8. Optimization of the travel.



11. Settings

11.2 Specific settings for induction motors (with encoder)

For induction motors auto tuning has to be performed before the first travel. The brake stays applied. To do so, the parameters described in the table below must be set.

Table 19. Basic setting for induction motor in closed loop

Function	Meaning	Factory setting	Setting
E46	Language setting (clear text function description)	1	Depends on the country
C21	Speed selection units (C21=0: rpm, C21=1: m/min or C21=2: Hz)	0	Depends on the installation
P01	Motor number of poles from manufacturer data sheet or motor name plate Must be set before setting F03 value!	4	Depends on the motor
F03	Motor's rated speed (from motor's name plate). The units are always rpm (not dependant on C21 setting). Normally F03 is motor speed at nominal lift speed	1500 rpm	Depends on the motor
L31	Maximum linear (in m/min) speed corresponding to F03 value. Used as linearization factor for speed settings	60.0	Depends on the installation
F04	Motor's synchronous speed. The units depend on the setting of function C21. For 4-pole motors (50Hz) is 1500 r/min, for 6-poles motors (50Hz) is 1000 r/min	1500 rpm	Depends on the motor
F05	Motor rated voltage from name plate (V)	380 V	Depends on the motor
F11	Overload detection level	Depends on the inverters capacity	Same as P03
P02	Motor rated capacity (power) from name plate (kW)	Depends on the inverters capacity	Depends on the motor
P03	Motor rated current from name plate in A	Depends on the inverters capacity	Depends on the motor
P04	Auto tuning mode. P04=1: measures P06 and P07 values P04=3: measures P07, P08 and P12 values and calculates P06 value	0	3
P06	Motor no-load current in A. The Auto tuning procedure calculates, the value of this function (when P04=3). The calculation overwrites the factory setting	Depends on the inverter capacity	Automatic
P07	Motor stator resistance (R1) in %. The Auto tuning procedure measures the value of this function (when P04=1 or 3). The measurement overwrites the factory setting	Depends on the inverter capacity	Automatic
P08	Motor stator reactance (X1) in %. The Auto tuning procedure measures the value of this function (when P04=1 or 3). The measurement overwrites the factory setting	Depends on the inverter capacity	Automatic
P12	Slip frequency in Hz. The Auto tuning procedure measures the value of this function (when P04=3). The measurement overwrites the factory setting	0.00 Hz	Automatic
L01	Encoder type	0	0
L02	Encoder resolution (pulses per revolution) from manufacturer data sheet or name plate	1024 p/rev	Depends on the encoder
L36	Speed loop controller (ASR) P gain for high speeds	10.00	10.00
L38	Speed loop controller (ASR) P gain for low speeds	10.00	10.00

Auto tuning procedure (executed from terminals) in 6 steps

To perform the described procedure the enable (EN1&EN2) inputs must be active.

1. Are the motor and encoder correctly connected?
2. Turn on inverter mains supply
3. **Please set the functions described in the above table**
4. Check that the inverter receives the encoder pulses as following: in the keypad go to Menu **4. I/O Check** and press the down arrow key until you reach the page that shows P1, Z1, P2 and Z2 (8/8). If the motor is not moving, the display should show **+0 p/s** after P2. Open (release) the brake and turn a little bit the motor. In this moment the display should show a number different than 0 (positive or negative depending on the rotation direction). If the display shows **----p/s** (or **+0 p/s** meanwhile the motor is turning) means that no signal is coming from the encoder. In this case please check the encoder cable and the connection of the signals.
5. Set function P04 to 2 and press FUNC/DATA
6. Give RUN command to the inverter from the lift controller (normally in RESCUE or INSPECTION mode). The main contactors will be closed and current will flow through the motor producing some acoustic noise. This procedure will take some seconds. After this auto tuning procedure is finished.

After that, please give RUN command from the lift controller (for example in INSPECTION), and check that motor is turning without any problem. In negative case (for example inverter trips OC, OS or Ere) please exchange motor phases connection to change rotation direction (for example U phase by V phase).



11. Settings

11.3 Specific settings for permanent magnet synchronous motors

For permanent magnet synchronous motors pole tuning has to be performed before the first travel. The brake stays applied. To do so, the parameters described in the table below must be set.

Table 20. Basic setting for synchronous motor

Function	Meaning	Factory setting	Setting
H03	Initialization of factory settings for synchronous motors	0	2
L01	Encoder type: ECN 1313 EnDat 2.1 or ERN 1387 (or compatible) is possible. See information from manufacturer data sheet or encoder name plate	0	4 for EnDat 2.1 5 for ERN1387
	Remove power supply from the inverter for a short time (ensure that Keypad is completely off)		
E46	Language setting (clear text function description)	1	Depends on the country
C21	Speed selection units (C21=0: rpm, C21=1: m/min or C21=2: Hz)	0	Depends on the installation
P01	Motor number of poles from manufacturer data sheet or motor name plate Must be set before setting F03 value!	20	Depends on the motor
F03	Motor's maximum speed. The units are always rpm (not dependant on C21 setting). Normally F03 is motor speed at nominal lift speed	60 rpm	Depends on the motor
L31	Maximum linear (in m/min) speed corresponding to F03 value. Used as linearization factor for speed settings	60.00	Depends on the installation
F04	Motor's rated speed (from motor's name plate). The units depend on the setting of function C21	60 rpm	Depends on the motor
F05	Motor rated voltage from name plate (V)	380 V	Depends on the motor
F11	Overload detection level	Depends on the inverters capacity	Same as P03
P02	Motor rated capacity (power) from name plate in kW	Depends on the inverters capacity	Depends on the motor
P03	Motor rated current from name plate in A	Depends on the inverter capacity	Depends on the motor
P06	Motor no-load current in A (for synchronous motor set this function to 0)	0 A	0 A
P07	Motor stator resistance R1 in %	5%	5%
P08	Motor stator reactance X1 in %	10%	10%
L02	Encoder resolution (pulses per revolution) from manufacturer data sheet or name plate	2048 p/rev	Depends on the encoder
L04	Offset angle obtained from pole tuning	0.00	Automatic
L05	Current loop controller (ACR) P gain	1.5	Depends on the motor
L36	Speed loop controller (ASR) P gain at high speeds	2.50	2.00
L38	Speed loop controller (ASR) P gain at low speeds	2.50	2.00

Pole tuning procedure in 7 steps:

To perform the described procedure the enable (EN1&EN2) inputs must be active.

1. Are motor and encoder connected properly?
2. Apply power to the inverter
3. **The functions mentioned in the table above must be set.**
Check that the inverter receives the encoder pulses as following: in the keypad go to Menu **4. I/O Check** and press the down arrow key until you reach the page that shows P1, Z1, P2 and Z2 (8/8). If the motor is not moving, the display should show **+0 p/s** after P2. Open (release) the brake and turn a little bit the motor. In this moment the display should show a number different than 0 (positive or negative depending on the rotation direction). If the display shows **----p/s** (or **+0 p/s** meanwhile the motor is turning) means that no signal is coming from the encoder. In this case please check the encoder cable and the connection of the signals.
4. Set function **L03 to 1** and press FUNC/DATA key.
5. Give RUN command to the inverter from the lift controller (normally in RESCUE or INSPECTION mode). The main contactors will be closed and current will flow through the motor producing some acoustic noise. This procedure will take some seconds. After the procedure was finished correctly the offset value is saved and shown in function **L04**. Write down the displayed value. If Er7 is displayed check the motor and encoder cabling and repeat steps 5 and 6.
6. If possible, open the brake and let the cabin move some centimetres.
7. Perform steps 5 and 6 again. The result in function L04 between different measurements must not differ more than $\pm 15^\circ$.

L05: Current loop regulator (ACR) P gain calculation

$$L05 = 4,33 \cdot \frac{I_n \times L}{V_n}$$

L=Motor inductance (minimum value between Ld and Lq) [mH]
 V_n=Motor rated voltage [V] (F05)
 I_n=Motor rated current [A] (P03)

11. Settings

11.4 Specific settings for induction motors in open loop (geared motors without encoder)

For induction motors auto tuning has to be performed before the first travel. The brake stays applied. To do so, the parameters described in the table below must be set.

Table 21. Basic setting for induction motor in open loop

Function	Meaning	Factory setting	Setting
E46	Language setting (clear text function description)	1	Depends on the country
C21	Speed selection units (C21=0: rpm, C21=1: m/min or C21=2: Hz)	0	2
P01	Motor number of poles from manufacturer data sheet or motor name plate Must be set before setting F03 value!	4	Depends on the motor
F03	Motor's rated speed (from motor's name plate). The units are always rpm (not dependant on C21 setting). Normally F03 is motor speed at nominal lift speed	1500 rpm	Depends on the motor
L31	Maximum linear (in m/min) speed corresponding to F03 value. Used as linearization factor for speed settings	60.0	Depends on the installation
F04	Motor's synchronous speed. The units depend on the setting of function C21. For 4-pole motors (50Hz) is 1500 r/min, for 6-poles motors (50Hz) is 1000 r/min	1500 rpm	Depends on the motor
F05	Motor rated voltage from name plate (V)	380 V	Depends on the motor
F09	Torque boost	0.0%	Depends on the application
F11	Overload detection level	Depends on the inverters capacity	Same as P03
F20	DC – Braking (Start speed)	0.00 rpm	0.20 Hz
F21	DC – Braking (Level)	0%	50%
F22	DC – Braking (Time)	0.00 s	1.00 s
F23	Start speed	0.00 Hz	0.50 Hz
F24	Start speed (Hold time)	0.00 s	1.00 s
F25	Stop speed	3.00 rpm	0.20 Hz
F42	Control type selection (for 37 and 45kW Dynamic torque vector control is not available)	0	2
P02	Motor rated capacity (power) from name plate in kW	Depends on the inverter capacity	Depends on the motor
P03	Motor rated current from name plate in A	Depends on the inverter capacity	Depends on the motor
P04	Auto tuning mode. P04=1: measures P06 and P07 values P04=3: measures P07, P08 and P12 values and calculates P06 value	0	3
P06	Motor no-load current in A. The Auto tuning procedure calculates, the value of this function (when P04=3). The calculation overwrites the factory setting	Depends on the inverter capacity	Automatic
P07	Motor stator resistance (R1) in %. The Auto tuning procedure measures the value of this function (when P04=1 or 3). The measurement overwrites the factory setting	Depends on the inverter capacity	Automatic
P08	Motor stator reactance (X1) in %. The Auto tuning procedure measures the value of this function (when P04=1 or 3). The measurement overwrites the factory setting	Depends on the inverter capacity	Automatic
P12	Slip frequency in Hz. The Auto tuning procedure measures the value of this function (when P04=3). The measurement overwrites the factory setting	0.00 Hz	Automatic
L83	Delay time for closing (applying) the brake after the speed is under stop speed (F25)	0.10 s	0.00 s

Auto tuning procedure (executed from input terminals) in 5 steps

To perform the described procedure the enable (EN1&EN2) inputs must be active.

1. Is the motor correctly connected?
2. Turn on inverter mains supply
3. **Please set the functions described in the above table**
4. Set function P04 to 3 and press FUNC/DATA
5. Give RUN command to the inverter from the lift controller (normally in INSPECTION mode). The main contactors will be closed and current will flow through the motor producing some acoustic noise. This procedure will take some seconds. After this auto tuning procedure is finished.

11. Settings

11.5 Additional settings for induction motor in open loop

- No-load current (function P06).

The no-load current (function P06) defines the value of the current of the motor when no load is applied to the motor (exciting current).

Typical values of the no-load current range from 30 % of P03 up to 70 % of P03. In the majority of the cases the value calculated by the auto-tuning procedure will be correct (when P04=3). In some cases the auto-tuning procedure cannot be finished correctly (due to special behaviour of the motor). In this later case the value of P03 must be set

manually. For calculate no-load current you can use the formula
$$P06 = \sqrt{(P03)^2 - \left(\frac{P02 * 1000}{1.47 * F05}\right)^2}$$

Too low values in P03 will make that the motor does not have enough torque. Too high values will make that the motor oscillates (this oscillation will cause a vibration in the motor that is transmitted to the cabin).

- Slip frequency (function P12).

The slip frequency function defines the value of the slip frequency of the motor. Is the key function for a good slip compensation by the inverter; this means that this function is very important in open loop control of induction motors for a good landing accuracy because it will ensure that the rotating frequency of the motor is the same regardless of the load condition of the motor.

In the majority of the cases the value measured by the auto-tuning procedure will be correct. In some cases the auto-tuning procedure cannot be finished correctly (due to special behaviour of the motor). In this later case the value of P12 must be set manually.

To set function P12 manually we can calculate it from the following formula:

$$P12 = \frac{(Synchronous_speed(rpm) - Rated_speed(rpm)) \times No_Poles}{120}$$

- Slip compensation gains (functions P09 for driving mode and P10 for braking mode)

The slip frequency can be also compensated in both driving and braking mode. The experimental method for adjust these values is following. You need to test one floor level with cabin empty going up and down:

- If the cabin speed going up is smaller than the desired speed (the cabin don't reach floor level) decrease 10% the value of P10 (braking mode).
- If the cabin speed going down is higher than the desired speed (the cabin pass floor level) decrease 10% the value of P09 (driving mode).

11.6 Setting the speed profile

The setting of the speed profile includes:

- Travelling speed
- Acceleration and deceleration times
- S curves

For the rated speed, each intermediate speed and creep speed the acceleration, deceleration times and S curves can be set independently. The setting of the S curve means the speed change in terms of percentage of the maximum speed (F03) used for the acceleration change.

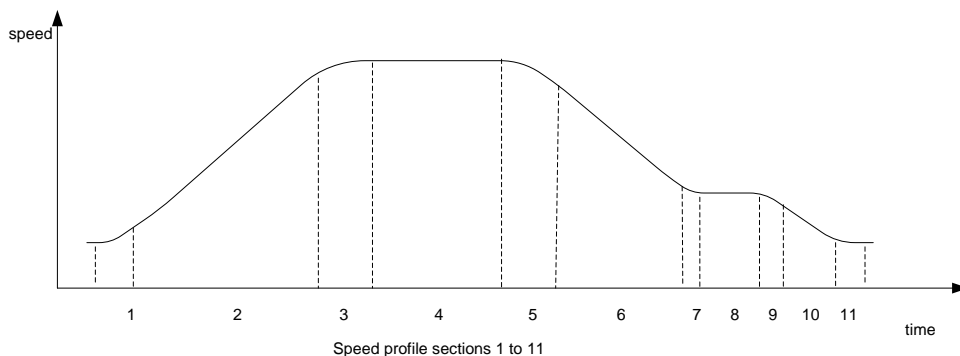

Figure 27: Speed profile using creep speed.

11. Settings

- For each speed the profile can be set independently.
The following table shows the corresponding functions for each phase of the sequence.

Table 22: Correspondence of functions for each phase of the sequence according with figures 22, 23 & 24.

Speed profile phase (fig. 24)	Meaning	Normal travel (fig. 22)	Case 1 (fig. 23)	Case 2 (fig. 23)	Case 3 (fig. 23)	Case 4 (fig. 23)	Case 5 (fig. 23)	Case 6 (fig. 23)
1	1 st S curve acceleration	L19	L19	L19	L19	L19	L19	L19
2	Linear acceleration	E12	E10	F07	F07	E10	F07	E10
3	2 nd S curve acc.	L24	L22	L20	L20	L22	L20	L22
4	Constant speed	C11	C05	C08	C09	C10	C09	C10
5	1 st S curve deceleration	L25	L23	L21	L21	L23	H57	H59
6	Linear dec.	E13	E11	F08	F08	E11	F08	F08
7	2 nd S curve dec.	L26	L26	L26	L26	L26	H58	H60
8	Creep speed	C07	C07	C07	C07	C07	C05	C08
9	1 st S curve deceleration	L28	L28	L28	L28	L28	L23	L21
10	Linear dec.	E14	E14	E14	E14	E14	E11	F08
11	2 nd S curve dec.	L28	L28	L28	L28	L28	L28	L28

- Intermediate speeds are seldom used in standard lifts. These speeds will be used with high speed lifts or between short floors
- For creepless operation (direct to floor) phases 7, 8, 9 and 10 do not appear. The setting of the S curve at stopping from creep speed to zero speed is set by function L28.
- For other combinations, please see table below

Table 23: Correspondence of acceleration and deceleration ramps and S-curves.

ACCELERATION & DECELERATION RAMPS (S-CURVES)									
AFTER CHANGE \ BEFORE CHANGE	STOP	C04	C05	C06	C07	C08	C09	C10	C11
STOP	-/F08 (-/-)	F07 (H57 / H58)	F07 (H57 / H58)	F07 (-/-)	F07 (H57 / H58)	F07 (H57 / H58)	F07 (H57 / H58)	F07 (H57 / H58)	F07 (H57 / H58)
C04	E16 (H59 / H60)	F07 / F08 (-/-)	E10 (L19 / L22)	F07 (-/-)	F07 / F08 (H57 / H58)	F07 (L19 / L20)	F07 (L19 / L20)	E10 (L19 / L22)	E12 (L19 / L24)
C05	E16 (H59 / H60)	E11 (L23 / L28)	F07 / F08 (-/-)	F07 / F08 (-/-)	E11 (L23 / L26)	F07 / F08 (H59 / H60)	F07 / F08 (H59 / H60)	F07 / F08 (H57 / H58)	F07 / F08 (H57 / H58)
C06	E16 (-/-)	F08 (-/-)	F07 / F08 (-/-)	F07 / F08 (-/-)	F07 / F08 (-/-)	F07 / F08 (-/-)	F07 / F08 (-/-)	F07 / F08 (-/-)	F07 / F08 (-/-)
C07	E15 (L27)	E14 (L28)	F07 / F08 (H57 / H58)	F07 / F08 (-/-)	F07 / F08 (-/-)	F07 / F08 (H57 / H58)	F07 / F08 (H57 / H58)	F07 / F08 (H57 / H58)	F07 / F08 (H57 / H58)
C08	E16 (H59 / H60)	F08 (L21 / L28)	F07 / F08 (H57 / H58)	F07 / F08 (-/-)	F08 (L21 / L26)	F07 / F08 (-/-)	F07 / F08 (H57 / H58)	F07 / F08 (H57 / H58)	F07 / F08 (H57 / H58)
C09	E16 (H59 / H60)	F08 (L21 / L28)	F07 / F08 (H57 / H58)	F07 / F08 (-/-)	F08 (L21 / L26)	F07 / F08 (H59 / H60)	F07 / F08 (-/-)	F07 / F08 (H57 / H58)	F07 / F08 (H57 / H58)
C10	E16 (H59 / H60)	E11 (L23 / L28)	F07 / F08 (H59 / H60)	F07 / F08 (-/-)	E11 (L23 / L26)	F07 / F08 (H59 / H60)	E11 (L23 / L26)	F07 / F08 (-/-)	F07 / F08 (H57 / H58)
C11	E16 (H59 / H60)	E13 (L25 / L28)	F07 / F08 (H59 / H60)	F07 / F08 (-/-)	E13 (L25 / L26)	F07 / F08 (H59 / H60)	E13 (L25 / L26)	F07 / F08 (H59 / H60)	F07 / F08 (-/-)

In order to know which ramps and S-curves are used we have to enter in Table 12 from the left hand column in the row of the speed that is settled before the change (ex. C08) and look up in the column pointing at the target speed after the change (ex. C09). In the intersection of the row and the column we can find the ramps (ex. F07 / F08) and the S-curves (in brackets, ex. H57/H58) used during the change. In the example the change uses F07 as acceleration ramp or F08 in case of deceleration; for the S-curves H57 is used at the beginning of the speed change (close to C08) and H58 is used at the end of the change (when the speed has reached C09).

11. Settings

11.7 Recommended values for acceleration and deceleration related functions

Table 24: Guideline of acceleration, deceleration times and deceleration distances for different travelling speeds

Rated speed	Creep speed	Acc./Dec. Times settings	S curve settings	Acc./Dec. Times settings	Deceleration distance
Function C11	Function C07	Function E13	Functions L24,L25,L26	Function E14	
0.6 m/s	0.05 m/s	1.6 s	25%	1.6 s	892 mm
0.8 m/s	0.10 m/s	1.7 s	25%	1.7 s	1193 mm
1.0 m/s	0.10 m/s	1.8 s	25%	1.0 s	1508 mm
1.2 m/s	0.10 m/s	2.0 s	25%	1.0 s	1962 mm
1.6 m/s	0.10 m/s	2.2 s	30%	1.0 s	2995 mm
2.0 m/s	0.15 m/s	2.4 s	30%	0.8 s	4109 mm
2.5 m/s	0.20 m/s	2.6 s	30%	0.7 s	5649 mm

The deceleration distance and therefore the starting point of the deceleration phase depends on the function settings. The deceleration distance shown in the above table is the distance from the start of the deceleration to the final floor landing position. The time during creep speed has been estimated for 1 s. This time depends on the real application.

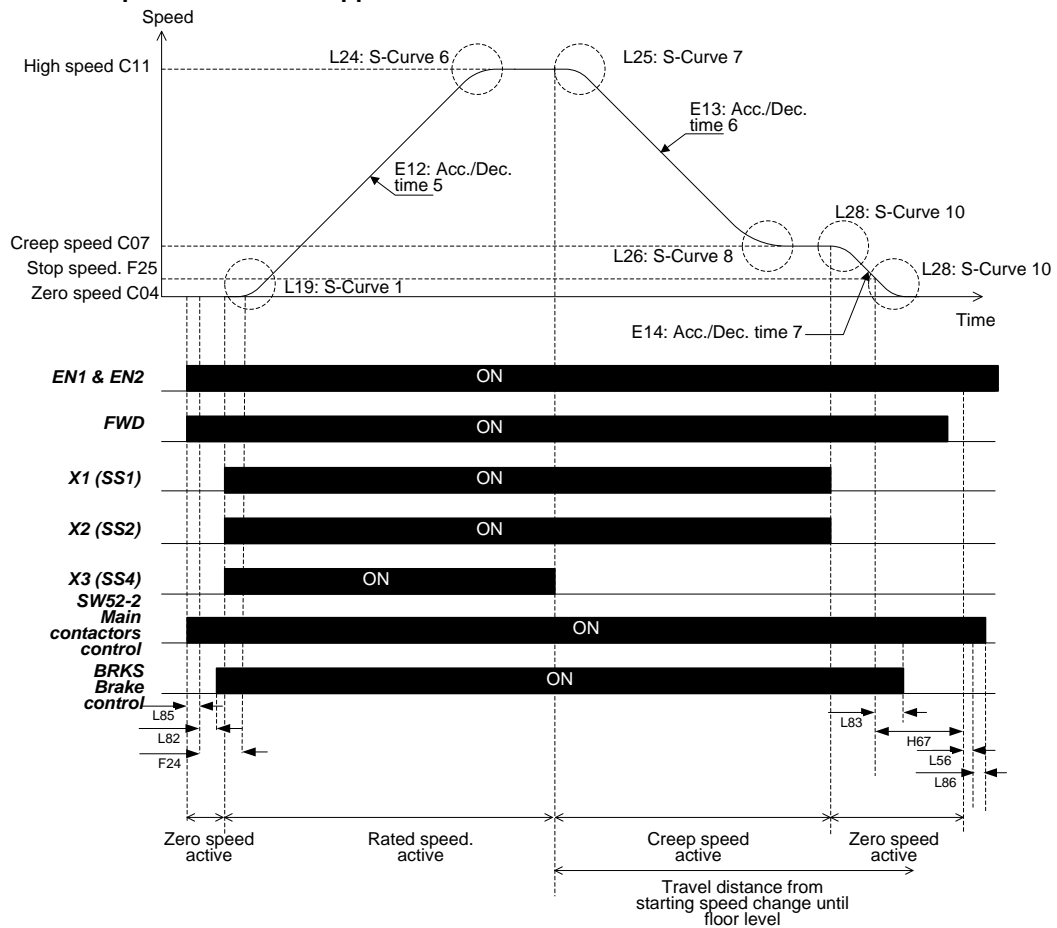

Figure 28. Complete time diagram for normal travel including main contactors control.

Factory setting of the speed units is rpm (defined by function C21). To set up all functions correctly the rated speed of the motor must be known. If this speed is NOT known it can be calculated from the formula below:

$$n_{rated} = \frac{19,1 \times v \times r}{D \times i}$$

Where
 v: rated speed in m/s
 r: Cabin suspension (1 for 1:1, 2 for 2:1, 4 for 4:1,...)
 D: Pulley diameter in m
 I : Gear ratio

12. Function tables

12.1 Travel optimization

Function	Factory setting	Explanation	Setting
L36	10.00	Speed loop controller P gain (ASR P) for high speeds. High values can lead to instability or noise in the motor for speeds higher than the value set in function L41.	Depends on the installation
L37	0.100 s	Speed loop controller Integral time (ASR I) for high speeds. This value normally does not need to be changed. Too high values can cause over/undershoot at the end of acceleration and deceleration phases from speeds higher than the value set in function L41.	Depends on the installation
L38	10.00	Speed loop controller P gain (ASR P) for low speeds. Same effect as L36, effective for speeds under the value set in function L40.	Depends on the installation
L39	0.100 s	Speed loop controller Integral time (ASR I) for low speeds. Same effect as L37, effective for speeds under the value set in function L40.	Depends on the installation
L40	150 r/min	Changing point of P and I values for small speeds. Under this speed the values in functions L38 and L39 are effective.	Depends on the installation
L41	300 r/min	Changing point of P and I values for high speeds. Over this speed the values in functions L36 and L37 are effective.	Depends on the installation
L56	0.2 s	Time for decreasing the current inside the motor at the stopping. This time must be increased in case the demagnetization process in a synchronous motor makes noise.	Depends on the installation
L82	0.2 s	Delay time for opening (releasing) the brake after operation command (FWD or REV) has been activated. This time should be bigger than the time required for the motor current to settle.	Depends on the installation
L83	0.1 s	Delay time for closing (applying) the brake after the speed is under stop speed (F25). It is very important that EN1&EN2 (enable) signals are deactivated and the main contactors are opened after the brake is closed.	Depends on the installation
L85	0.1s	Delay time from closing the main contactors until the inverter starts giving current (voltage) at the output	Depends on the installation
L86	0.1s	Delay time from stopping giving current at the output until the inverter opens the main contactors	Depends on the installation

For most applications the factory default settings are enough for good comfort and low noise.

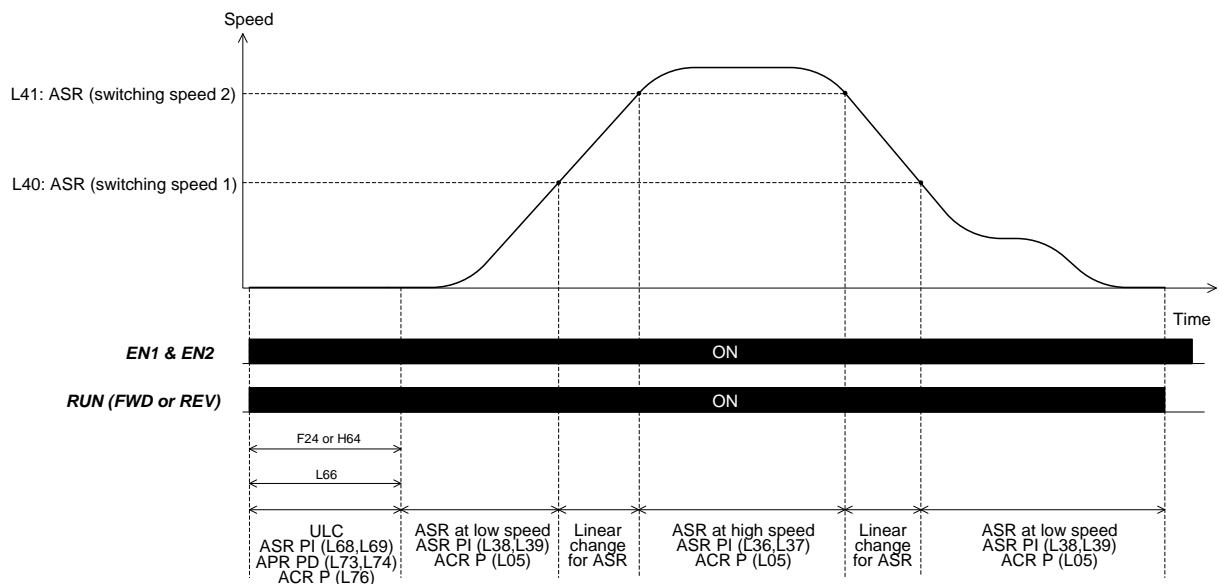

Figure 29. Time diagram with Unbalanced Load Compensation (ULC) active (L65 = 1).

When L76=0, then L05 is effective during all the time

12. Function tables

2.2 Start and stop optimization

Function	Factory setting	Explanation	Setting
F20	0.00 r/min	DC braking: Start Frequency (only in open loop operation F42=2)	Depends on the installation
F21	0 %	DC braking level (only in open loop operation F42=2)	Depends on the installation
F22	0.00 s	DC braking time (only in open loop operation F42=2)	Depends on the installation
F23	0.0 r/min	Start speed	Depends on the installation
F24	1s	Hold time for starting to move after activation of operation command and speed command. A value too small may cause a high jerk (the motor starts to move and the brake is still closed)	Depends on the installation
F25	3.0 r/min	Stop Speed. The setting of this function determines the actual speed value to trigger the timing (L83) for the brake closing sequence and the stop speed holding time (H67)	Depends on the installation
H64	0.0 s	For closed loop and gearless machines zero speed holding time. For open loop machines DC braking time at starting.	Depends on the installation
H65	0.0 s	Ramp for soft start of start speed F23. For installation with high friction only in closed loop and gearless machines.	Depends on the installation
H67	0.5 s	Hold time at zero speed at stopping (F25). After this time the inverter stops giving current to the motor	Depends on the installation
L65	0	Unbalanced load compensation activation (enable)	Depends on the installation
L66	0.5 s	Unbalanced load compensation activation time	Depends on the installation
L68	10.00	Unbalanced load compensation speed proportional gain	Depends on the installation
L69	0.010 s	Unbalanced load compensation integral time	Depends on the installation
L73	0.00	Unbalanced load compensation position proportional gain	Depends on the installation
L74	0.00	Unbalanced load compensation position derivative gain	Depends on the installation
L76	0.00	Unbalanced load compensation current proportional gain. In case of 0.00, current proportional gain used is the one set on L05.	Depends on the installation

12.3 Additional functions and settings if needed

Function	Factory setting	Explanation	Setting
C21	0 r/min	0: r/min 1: m/min 2: Hz	r/min
E31	1500 r/min 60 r/min	Y3 Output will become active, when the speed reaches the value set in this function	If used in the installation
E32	15 0.6	Hysteresis under speed E31. When the actual speed is under (E31-E32) value the output Y3 will be deactivated.	If used in the installation
F42	0	Induction motor control with encoder (closed loop)	Depends on the installation
	1	Permanent magnet synchronous motor control	
	2	Induction motor control without encoder (open loop) (for 37 and 45kW Dynamic torque vector control is not available)	
H04	0	This function sets the number of attempts of alarm Auto Reset.	Value from 1 to 10
H05	5 s	Delay time for executing alarm Auto Reset	Time between 0,5s and 20 s
H98	81	Protection and maintenance function (Bitwise function, see table 18)	Depends on the installation
L07	0	Automatic pole tuning after first RUN command (after power ON)	1,3 or 4
L80	1	1: Brake control by time (Standard setting) 2: Brake control by output current	1
L29	0.00	Hold time for short floor operation	Depends on the installation
L30	0.00	Speed limit for the classical short floor operation (time-speed control).	Rated speed -10 %
L86	0.1 s	When the main contactors are controlled by the inverter, this function is the delay time for opening the main contactors after the inverter stops giving current at the output	0.1 s
L87	450 r/min 18 r/min	Speed limit for anticipated door opening	If used in the installation

12. Function tables

12.4 Input and output terminals function settings

Function	Factory setting	Explanation	Setting
E01	0	X1-X8 digital inputs function: 0: bit 0 of binary code for speed selection inputs (SS1) 1: bit 1 of binary code for speed selection inputs (SS2) 2: bit 2 of binary code for speed selection inputs (SS4) 8: External reset for alarm messages (RST) 9: Enable external alarm trip (THR) 10: Enable jogging operation (JOG) 63: Battery operation enable (low voltage cancellation) (BATRY)	0
E02	1		1
E03	2		2
E04	8		8
E05	60		--
E06	61		--
E07	62		--
E08	63		63
E20	12	Y1-Y4 transistor output function: 0: Inverter running (RUN) 2: Speed detected (FDT)	12
E21	78		78
E22	2		2
E23	57	12: Main contactors control mode 1(SW52-2) 57: Brake control (BRKS) 78: Door open (DOPEN) 99: Alarm output for any alarm (ALM) 107: During magnetic pole position offset tuning (DTUNE) 109: Recommended running direction (RRD) 112: Input power limitation (IPL) 114: Main contactors control mode 2 (SW52-3) 115: Pole tuning done signal (PTD) 116: Detected speed direction signal (DSD)	57
E24	57	Y5A/C and 30A/B/C relay output function: 0: Inverter running (RUN) 2: Speed detected (FDT) 12: Main contactors control mode 1(SW52-2) 78: Door open (DOPEN) 99: Alarm output for any alarm (ALM) 107: During magnetic pole position offset tuning (DTUNE) 109: Recommended running direction (RRD) 112: Input power limitation (IPL) 114: Main contactors control mode 2 (SW52-3) 115: Pole tuning done signal (PTD) 116: Detected speed direction signal (DSD)	57
E27	99		99

12.5 Bit assignment of functions H98 and L99

Function	Bit	Explanation	Setting
H98	0	Automatic change of switching frequency	0 = OFF 1 = ON
	1	Activation of input phase loss detection	
	2	Activation of output phase loss detection	
	3	Select life judgment criteria of DC link bus capacitor	0 = Factory setting 1 = User
	4	Judge the life of DC link bus capacitor	0 = OFF 1 = ON
	5	Disable DC fan lock detection	
	6	Detect a short-circuit in the output phase at startup	
7	Disable heat sink thermistor detection		
L99	0	Current confirmation for synchronous motor	0 = OFF 1 = ON
	1	Rewrite magnetic pole position offset angle	
	2	Initial torque bias and reference torque decreasing	
	3	Short floor alternative selection	0 = Classical 1 = Distance control
	4	Direction assignment for DCP 3. Up means:	0 = FWD 1 = REV
	5	Reserved	0 = OFF 1 = ON
	6	DOPEN not dependant on EN1&EN2 or BX (BBX) signals	
7	Reserved		

13. Special operation

13.1 Short floor operation

If the distance between the two floors is shorter than the distance needed for acceleration and deceleration to/from high speed FRENIC-Lift is able to perform the so called *short floor operation*. There are two alternatives of short floor operation.

a. Alternative 1: *Classical short floor (frequency-time control)*

With this alternative the control is done by frequency and time. If the actual frequency is smaller than L30 value then the actual frequency (after interrupting the acceleration and reaching constant speed) will be held for the time set in function L29.

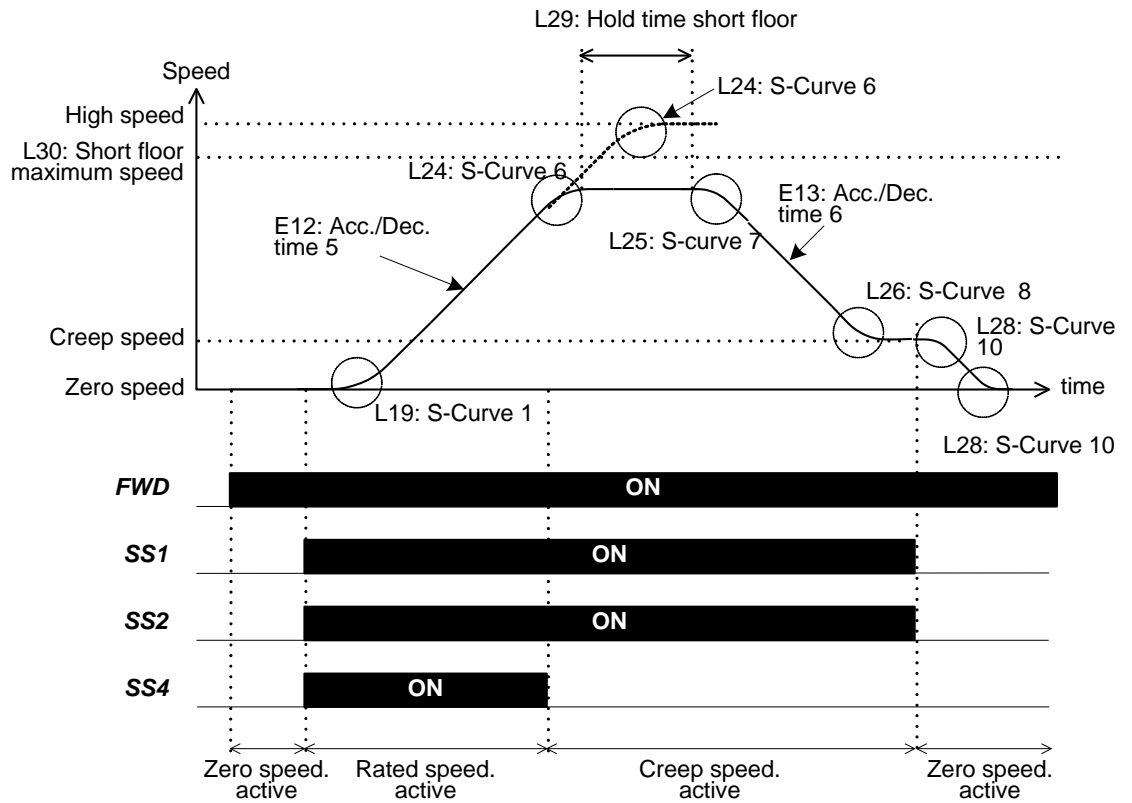

Figure 30. *Classical short floor operation (frequency-time control).*

To use this alternative bit 3 of function L99 must be set to 0.

13. Special operation

b. Alternative 2: Short floor with constant distance control

With this alternative the inverter keeps the deceleration distance (from high speed to creep speed) regardless of the actual speed and acceleration. The needed S-curves are calculated to fulfil this condition.

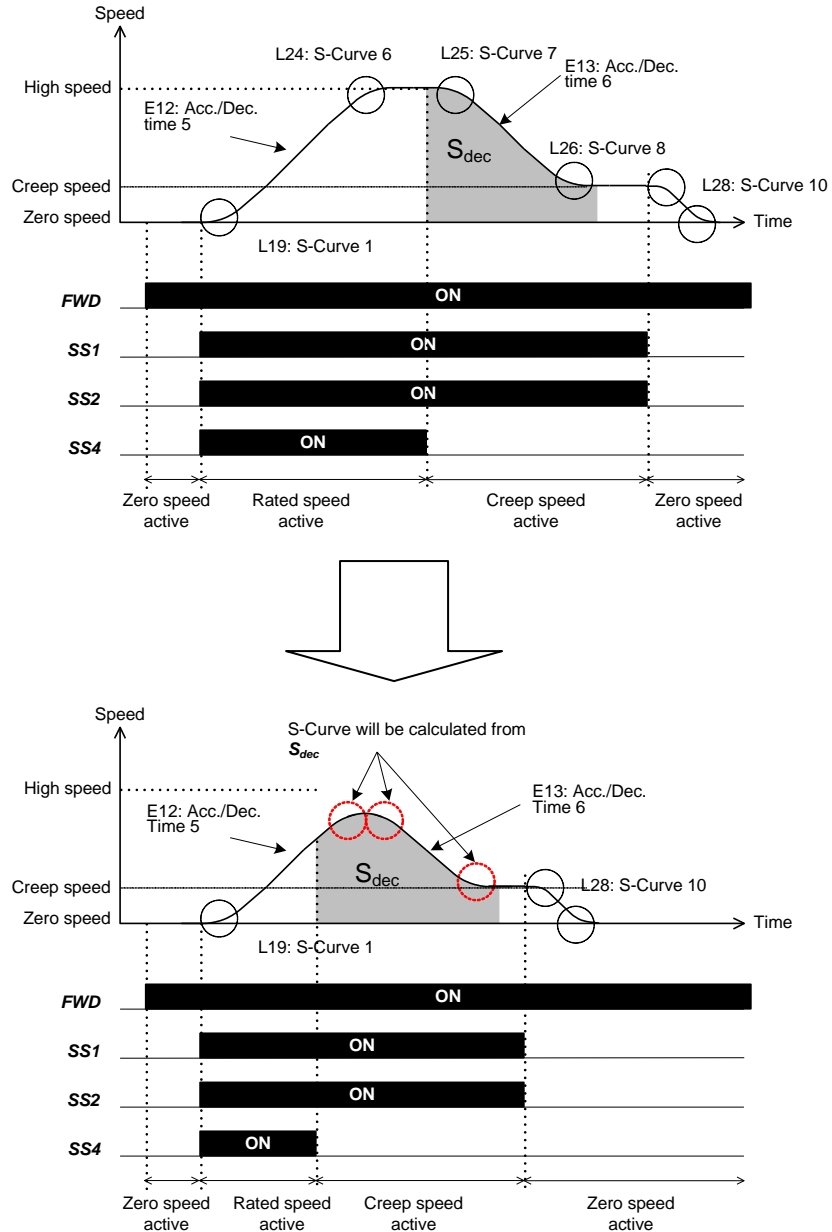

Figure 31. Short floor operation with constant distance control.

To use this alternative of short floor set bit 3 of function L99 to 1.
With this method functions L29 and L30 are not used.

⚡ This function is only available when accelerating from C04 to C09, C10 or C11, The inverter is forced to decelerate to C07.

13. Special operation

13.1 Creepless operation

Functions L31 (linearization factor from linear to rotational speed) and L34 (travelling distance for creepless operation) MUST be calculated and set before using creepless operation.

Creepless operation starts when all speed selection signals are removed during deceleration from High speed to Creep speed (after removing the signals for High speed and before reaching Creep speed). For better landing performance it is needed to set up properly functions L36 to L42 (ASR gains).

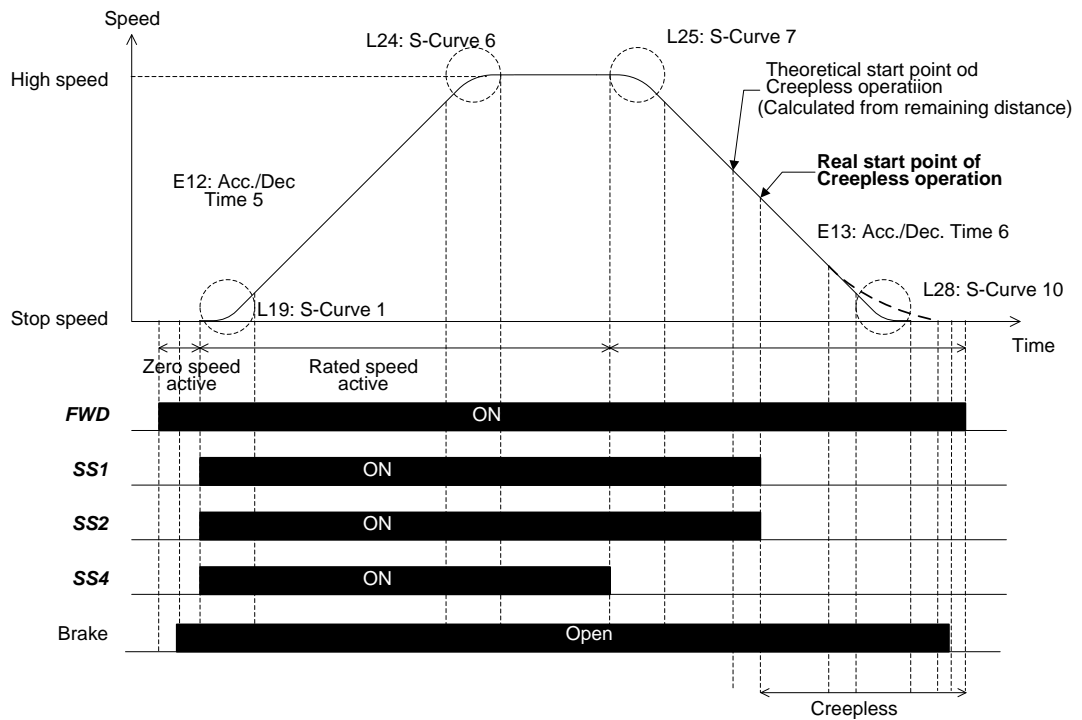

Figure 32. Creepless operation.

14. Recovering the lift from speed limiter condition

To recover the lift from speed limiter condition (cabin or counterweight are blocked), use inspection speed (C06). The reason is that S curve is not effective (only linear acceleration/deceleration) when inspection speed is used.

If the jerk is not enough to recover the lift, decrease the value of function F07 to increase the jerk against the speed limiter condition.

15. Rescue operation

To activate the rescue (battery operation) the signal BATTERY must be activated (by default programmed to input X8). The controller has to activate EN1 and EN2 (enable), FWD or REV (direction) and binary speed coding function L12 (speed) signals -like in normal operation- and the motor will start to move at C03 (battery speed). The ramps in that case are E17 and S curves are disabled. If binary speed coding function selected is other than L12 the speed, ramps and S-curves will be the specified in the standard table.

The torque in closed loop and gearless applications (for driving mode only) can be limited to avoid an overload during battery operation. The torque limit level can be set in function C01. The time that the limiting value becomes effective can be set in function C02. In order to make C01 effective during all travel, the setting value of C02 must be 0.0 s.

Setting value: C02 ≠ 0.0 s

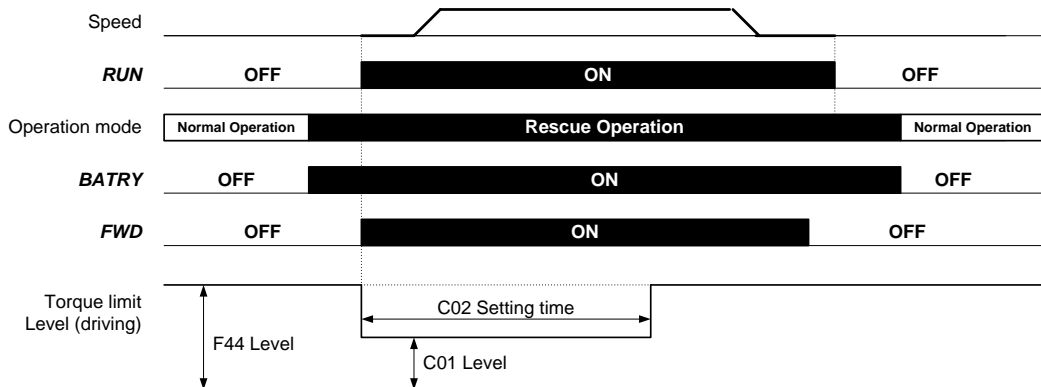

Figure 33. Battery operation using torque limit function.

Digital outputs [Y1] to [Y4], [Y5A/C] and [30A/B/C] of the inverter can be programmed to **RRD (Recommended Running Direction)** function (signal). This signal gives the recommended direction of travelling (motion) for rescue operation.

Table 25. Function RRD setting

Set up value for E20 to E24 or E27		Assigned Function	Symbol
Positive Logic	Inverse Logic		
109	1109	Recommended running direction	RRD

RRD signal informs the direction of regenerative operation. This signal is saved in case of mains loss until the next travel.

Function 26. Function RRD meaning

RRD		Specification
109 (positive Logic)	1109 (inverse Logic)	
OFF	ON	The inverter recommends REVERSE direction (REV)
ON	OFF	The inverter recommends FORWARD direction (FWD)

In the case of open loop control, if the reference speed is smaller than 5% of the base speed, RRD is not judged. Function E39 is the **RRD** detection level. Please use this function only for geared motors. Setting range: 0 to 100%

Setting procedure

1. Please confirm the reference torque during the nominal speed of the lift with balanced load condition.
2. Write down the value of the reference torque during up and down.
3. Please compare both values, and set the larger value to function E39.

Note In case of open loop control (F42=2) and rescue operation with batteries, use brake control by output current (L80=2), otherwise brake could open anyway when batteries are discharged.

16. Soft start for closed loop installations (IM and PMSM) with high friction

The inverter keeps zero speed (C04) during the time set in function H64, after main contactors are closed. The factory setting of H64 is 0.00 (not active) and the setting range is from 0.00 to 10.00 s. After this time, the motor starts to turn at speed F23 during F24 time (using acceleration H65). This function may be used to obtain a soft start in lift installations with high friction.

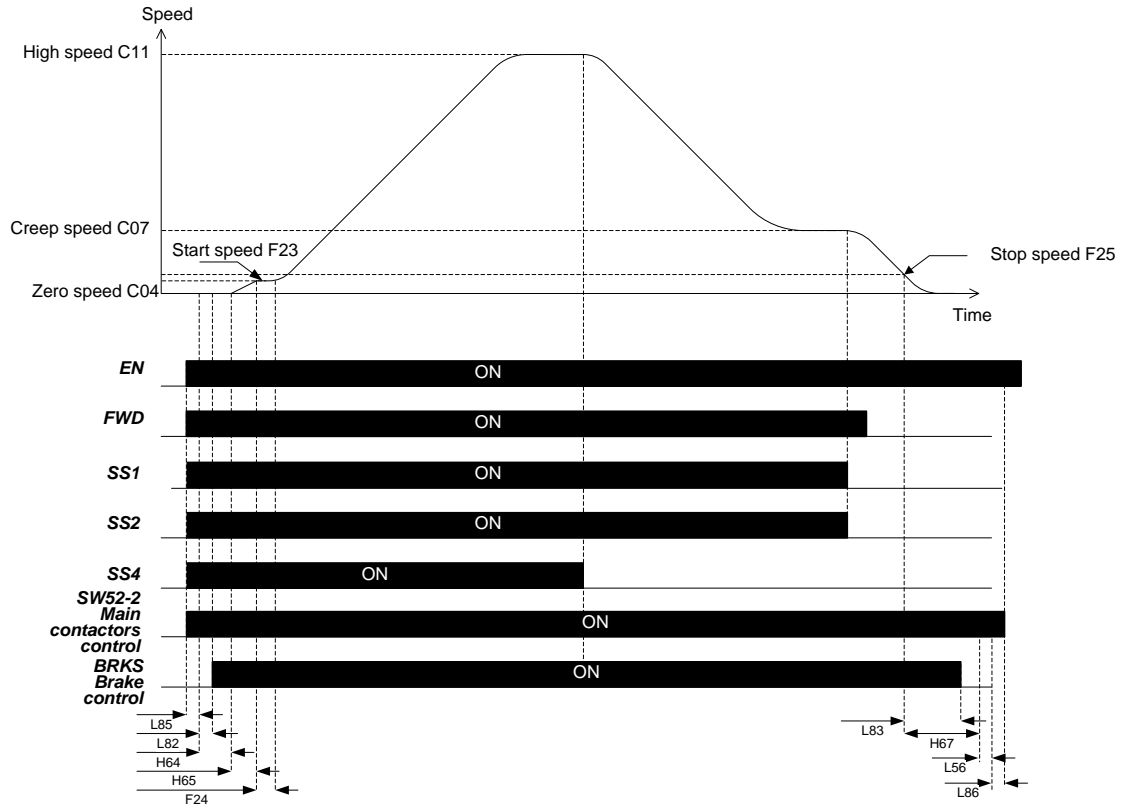

Figure 34. Signals timing diagram using soft start function.

Delay time after closing main contactors (L85) to start giving current to the motor
 Delay time for releasing (opening) the brake (L82)
 Hold time for zero speed (H64)
 Time (H65) for soft start of start speed (F23)
 Hold time for start speed (F24)

Delay time for brake apply (close) (L83)
 Hold time (H67) of RUN command after reaching stop speed (F25)
 Time for decreasing the current inside the motor at the stopping (L56)
 Delay time for opening main contactors (L86)

In case of using this function, rollback compensation (ULC) will be active as soon as H64 starts (and L65=1).

17. Alarm messages

Alarm message Displayed	Description	Possible causes
00c	Motor overloaded: OC1= Overload during acceleration OC2= Overload during deceleration OC3= Overload during constant speed	a) Check if the motor used in the application has been selected properly b) Check if the inverter used in the application has been selected properly c) Check if brake opens d) Has the pole tuning procedure been completed successfully?
0u	Overvoltage in inverter DC link: OU1= Overvoltage during acceleration OU2= Overvoltage during deceleration OU3= Overvoltage during constant speed	a) Braking resistor not connected or defective b) Counterweight not counterbalanced c) Deceleration time too short d) Check connection e) Check mains connection
1u	Undervoltage in inverter DC link	a) Supply voltage too low b) Mains supply failure c) Acceleration too fast d) Load too high e) Check connection of the input signal
1in	Input phase loss	a) Check inverters input protections b) Check input connections
0p1	Output phase loss	a) Misconnection on inverters side b) Misconnection on motors side c) Misconnection on main contactors
0h1	Inverter heat sink temperature too high	a) Inverter fan defective b) Ambient temperature too high
0h2	External Alarm	Digital input programmed with value 9 (THR) is not active.
0h3	Ambient temperature around inverter too high	Check temperature inside electrical cabinet
0h4	Motor over temperature detected from temperature sensor (PTC). See H26	a) Motor fan too small b) Ambient temperature too high c) Check setting of H26,H27
pg	Encoder error	a) Check encoder cable b) Motor is blocked c) Brake did not open
0l1	Motor overload	a) Check brake b) Motor, car or counterweight blocked c) Inverter at current limit, possibly too small d) Check functions F10-F12
0lu	Inverter overload	a) Over temperature in IGBT b) Failure in the cooling system c) Switching frequency (function F26) too high d) Cabin load too high
er1	Save error	Data has been lost
er2	Keypad communication error	Keypad was removed while inverter in operation (RUN)
er3	CPU error	Failure in the inverter CPU
er4	Option card communication error	A communication error occurred between the option card and the inverter. a) Check option card installation b) Check cables and shield connection
er5	Option card error	A communication error occurred between the option card and the encoder. a) Check encoder b) Check cables and shield connection

17. Alarm messages

Alarm message Displayed	Description	Possible causes
er6	Operation error	a) Check function L11-L18: One/many binary combinations are repeated b) Check brake signal status if BRKE function is used c) Check MC signal status if CS-MC function is used d) Check function L84 e) Check function L80,L82,L83 f) If F42=1 and L04=0.00. Pole tuning not done g) EN81-1+A3 function is active but another related function is missed
er7	Error during Auto Tuning / Pole tuning	a) Connection between inverter and motor interrupted during auto tuning procedure (main contactors open?) b) Enable input interrupted c) Check encoder cable d) Check encoder
er8	RS 485 Communications error	a) Cable is interrupted b) High noise level
ere	Speed error (disagreement)	a) Check brake b) Motor, car or counterweight blocked c) Check functions L90~L92 d) Current limiter active e) Has been completed successfully the pole tuning procedure?
erh	Option card hardware error	a) Option b) Option card not correctly installed c) Inverter software version not compatible with option card
ert	CAN bus communication error	a) CAN bus disconnected from the inverter b) Electrical noise, connect cable shield
ecf	EN1 and EN2 terminals circuit error	The inverter detects an error on the enable terminals circuit, and stops itself. Contact with Fuji Electric.
0s	Motor speed greater than $\frac{L32 \times F03}{100}$ (rpm)	a) Check encoder resolution setting in function L02 b) Check value of function F03 c) Check value of function P01 d) Check value of function L32
pbf	Charging circuit fault	Fault in the charging circuit of 37 and 45 kW inverters. Check power supply in R0/T0 terminals. Contact with Fuji Electric.
bbe	Brake status monitoring according to EN81-1+A3	Brake state differs from expected. For additional information, please contact Fuji Electric.

**CONTACT INFORMATION**

Headquarters Europe

Fuji Electric Europe GmbH

Goethering 58
63067 Offenbach/Main
Germany
Tel.: +49 (0) 69 669029 0
Fax: +49 (0) 69 669029 58
info.inverter@fujielectric-europe.com
www.fujielectric-europe.com

Headquarters Japan

Fuji Electric Co., Ltd.

Gate City Ohsaki East Tower,
11-2 Osaki 1-chome, Shinagawa-ku,
Chuo-ku
Tokyo 141-0032
Japan
Tel: +81 (0) 3 5435 7280
Fax: +81 (0) 3 5435 7425
www.fujielectric.com

Swiss Branch

Fuji Electric Europe GmbH

Park Altenrhein
9423 Altenrhein
Tel.: +41 (0) 71 858 29 49
Fax.: +41 (0) 71 858 29 40
info.swiss@fujielectric-europe.com
www.fujielectric-europe.com

Spanish Branch

Fuji Electric Europe GmbH

Sucursal en España
Ronda Can Fatjó 5, Edifici D, Local B
Parc Tecnològic del Vallès
08290 Cerdanyola (Barcelona)
Tel.: +34 (0) 935 824 333
Fax: +34 (0) 935 824 344
info.spain@fujielectric-europe.com
www.fujielectric-europe.com

French Branch

Fuji Electric Europe GmbH

265 Rue Denis Papin
38090 Villefontaine
Tel.: +33 (0) 4 74 90 91 24
Fax: +33 (0) 4 74 90 91 75
info.france@fujielectric-europe.com
www.fujielectric-europe.com

Italian Branch

Fuji Electric Europe GmbH

Via Rizzotto 46
41126 Modena (MO)
Tel.: +39 059 4734 266
Fax: +39 059 4734 294
info.italy@fujielectric-europe.com
www.fujielectric-europe.com

UK Branch

Fuji Electric Europe GmbH

Tel.: +44 (0) 7989 090 783
info.uk@fujielectric-europe.com
www.fujielectric-europe.com

Subject to change without prior notice